

MIT OpenCourseWare
<http://ocw.mit.edu>

Haus, Hermann A., and James R. Melcher. *Electromagnetic Fields and Energy*. Englewood Cliffs, NJ: Prentice-Hall, 1989. ISBN: 9780132490207.

Please use the following citation format:

Haus, Hermann A., and James R. Melcher, *Electromagnetic Fields and Energy*. (Massachusetts Institute of Technology: MIT OpenCourseWare). <http://ocw.mit.edu> (accessed MM DD, YYYY). Also available from Prentice-Hall: Englewood Cliffs, NJ, 1989. ISBN: 9780132490207. License: Creative Commons Attribution-Noncommercial-Share Alike.

Note: Please use the actual date you accessed this material in your citation.

For more information about citing these materials or our Terms of Use, visit:
<http://ocw.mit.edu/terms>

OVERVIEW OF ELECTROMAGNETIC FIELDS

15.0 INTRODUCTION

In developing the study of electromagnetic fields, we have followed the course summarized in Fig. 1.0.1. Our quest has been to make the laws of electricity and magnetism, summarized by Maxwell's equations, a basis for understanding and innovation. These laws are both general and simple. But, as a consequence, they are mastered only after experience has been gained through many specific examples. The case studies developed in this text have been aimed at providing this experience. This chapter reviews the examples and intends to foster a synthesis of concepts and applications.

At each stage, simple configurations have been used to illustrate how fields relate to their sources, whether the latter are imposed or induced in materials. Some of these configurations are identified in Section 15.1, where they are used to outline a comparative study of electroquasistatic, magnetoquasistatic, and electrodynamic fields. A review of much of the outline (Fig. 1.0.1) can be made by selecting a particular class of configurations, such as cylinders and spheres, and using it to exemplify the material in a sequence of case studies.

The relationship between fields and their sources is the theme in Section 15.2. Again, following the outline in Fig. 1.0.1, electric field sources are unpaired charges and polarization charges, while magnetic field sources are current and (paired) magnetic charges. Beginning with electroquasistatics, followed by magnetoquasistatics and finally by electrodynamics, our outline first focused on physical situations where the sources were constrained and then were induced by the presence of media. In this text, magnetization has been represented by magnetic charge. An alternative commonly used formulation, in which magnetization is represented by "Ampèrian" currents, is discussed in Sec. 15.2.

As a starting point in the discussions of EQS, MQS, and electrodynamic fields, we have used idealized models for media. The limits in which materials behave as

“perfect conductors” and “perfect insulators” and in which they can be said to have “infinite permittivity or permeability” provide yet another way to form an overview of the material. Such an approach is taken at the end of Sec. 15.2.

Useful as these idealizations are, their physical significance can be appreciated only by considering the relativity of perfection. Although we have introduced the effects of materials by making them ideal, we have then looked more closely and seen that “perfection” is a relative concept. If the fields associated with idealized models are said to be “zero order,” the second part of Sec. 15.2 raises the level of maturity reflected in the review by considering the “first order” fields.

What is meant by a “perfect conductor” in EQS and MQS systems is a part of Sec. 15.2 that naturally leads to a review in Sec. 15.3 of how characteristic times can be used to understand electromagnetic field interactions with media. Now that we can see EQS and MQS systems from the perspective of electrodynamics, Sec. 15.3 is aimed at an overview of how the spatial scale, time scale (frequency), and material properties determine the dominant processes. The objective in this section is not only to integrate material, but to add insight into the often iterative process by which a model is made to both encapsulate the essential physics and serve as a basis of engineering innovation.

Energy storage and dissipation, together with the associated forces on macroscopic media, provide yet another overview of electromagnetic systems. This is the theme of Sec. 15.4, which summarizes the reasons why macroscopic forces can usually be classified as being either EQS or MQS.

15.1 SOURCE AND MATERIAL CONFIGURATIONS

We can use any one of a number of configurations to review physical phenomena outlined in Fig. 1.0.1. The sections, examples, and problems associated with a given physical situation are referenced in the tables used to trace the evolution of a given configuration.

Incremental Dipoles. In homogeneous media, dipole fields are simple solutions to Laplace’s equation or the wave equation in two or three dimensions and have been used to represent the range of situations summarized in Table 15.1.1. As introduced in Chap. 4, the dipole represented closely spaced equal and opposite electric charges. Perhaps these charges were produced on a pair of closely spaced conducting objects, as shown in Fig. 3.3.1a. In Chap. 6, the electric dipole was used to represent polarization, and a distinction was made between unpaired and paired (polarization) charges.

In representing conduction phenomena in Chap. 7, the dipole represented a closely spaced pair of current sources. Rather than being a source in Gauss’ law, the dipole was a source in the law of charge conservation.

In magnetoquasistatics, there were two types of dipoles. First was the small current loop, where the dipole moment was the product of the area, a , and the circulating current, i . The dipole fields were those from a current loop, far from the loop, such as shown in Fig. 3.3.1b. As we will discuss in Sec. 15.2, we could have used current loop dipoles to represent magnetization. However, in Chap. 9,

TABLE 15.1.1 SUMMARY OF INCREMENTAL DIPOLES	
<u>Electroquasistatic charge:</u> Point; Sec. 4.4, Line; Prob. 4.4.1, Sec. 5.7	
<u>Electroquasistatic polarization:</u> Sec. 6.1	
<u>Stationary conduction current:</u> Point; Example 7.3.2 Line; Prob. 7.3.3	
<u>Magnetoquasistatic current:</u> Point; Example 8.3.2 Line; Example 8.1.2	
<u>Magnetoquasistatic magnetization:</u> Sec. 9.1	
<u>Electric Electrodynamic:</u> Point; Sec. 12.2	
<u>Magnetic Electrodynamic:</u> Point; Sec. 12.2	

magnetization was represented by magnetic dipoles, a pair of equal and opposite magnetic charges. Thus, the developments of polarization in Chap. 6 were directly applicable to magnetization.

To create the time-varying positive and negative charges of the electric dipole, a current is required. In Fig. 3.3.1a, this current is supplied by the voltage source. In the EQS limit, the magnetic field associated with this current is negligible, as are the effects of the associated magnetic field. In Chap. 12, where the laws of Faraday and Ampère were made self-consistent, the coupling between these laws was found to result in electromagnetic radiation. Electric dipole radiation existed because the charging currents created some magnetic field and that, in turn, induced a rotational electric field. In the case of the magnetic dipole shown last in Table 15.1.1, electromagnetic waves resulted from a displacement current induced by the time-varying magnetic field that, in turn, produced a more rotational magnetic field.

Planar Periodic Configurations. Solutions to Laplace's equation in Cartesian coordinates are all that is required to study the quasistatic and "steady" situations outlined in Table 15.1.2. The fields used to study these physical situations, which are periodic in a plane that "extends to infinity," are by nature decaying in the direction perpendicular to that plane.

The electrodynamic fields studied in Sec. 12.6 have this same decay in a direction perpendicular to the direction of periodicity as the frequency becomes low. From the point of view of electromagnetic waves, these low frequency, essentially Laplacian, fields are represented by nonuniform plane waves. As the frequency is raised, the nonuniform plane waves become waves that propagate in the direction in which they formerly decayed. Solutions to the wave equation can be spatially periodic in both directions. The TE and TM electrodynamic field configurations that conclude Table 15.1.2 help put into perspective those aspects of the EQS and MQS configurations that do not involve losses.

Cylindrical and Spherical. A few simple solutions to Laplace's equation are sufficient to illustrate the nature of fields in and around cylindrical and spherical material objects. Table 15.1.3 shows how a sequence of case studies begins with EQS and MQS fields, respectively, in systems of "perfect" insulators and "perfect" conductors and culminates in the very different influences of finite conductivity on EQS and MQS fields.

Fields Between Plane Parallel Plates. Uniform and piece-wise uniform quasistatic fields are sufficient to illustrate phenomena ranging from EQS, the "capacitor," to MQS "magnetic diffusion through thin conductors," Table 15.1.4. Closely related TEM fields describe the remaining situations.

Axisymmetric (Coaxial) Fields. The case studies summarized in Table 15.1.4 under this category parallel those for fields between plane parallel conductors.

TABLE 15.1.2	
PLANAR PERIODIC CONFIGURATIONS	
<u>Field Solutions</u>	
Laplace's equation:	Sec. 5.4
Wave equation:	Sec. 12.6
<u>Electroquasistatic (EQS)</u>	
Constrained Potentials and Surface Charge:	Examp. 5.6.2
Constrained Potentials and Volume Charge:	Examp. 5.6.1
	Probs. 5.6.1-4
Constrained Potentials and Polarization:	Probs. 6.3.1-4
Charge Relaxation:	Probs. 7.9.7-8
<u>Steady Conductor (MQS or EQS)</u>	
Constrained Potential and Insulating Boundary:	Prob. 7.4.3
<u>Magnetoquasistatic (MQS)</u>	
Magnetization:	Examp. 9.3.2
Magnetic diffusion through Thin Conductors:	Probs. 10.4.1-2
<u>Electrodynamic</u>	
Imposed Surface Sources:	Examps. 12.6.1-2
	Probs. 12.6.1-4
Imposed Sources with Perfectly	Examp. 12.7.2
Conducting Boundaries:	Probs. 12.7.3-4
	Probs. 13.2.1
Perfectly Insulating Boundaries:	Sec. 13.5
	Probs. 13.2.3-4
	Probs. 13.5.1-4

TABLE 15.1.3		
CYLINDRICAL AND SPHERICAL CONFIGURATIONS		
<u>Field Solutions to Laplace's Equation:</u> Cylindrical; Sec. 5.7 Spherical; Sec. 5.9		
<u>Electroquasistatic</u>		
Equipotentials:	Examp. 5.8.1	Examp. 5.9.2
Polarization:		
Permanent:	Prob. 6.3.6	Examp. 6.3.1 Prob. 6.3.5
Induced:	Examp. 6.6.2	Probs. 6.6.1-2
Charge Relaxation:	Probs. 7.9.4-5	Examp. 7.9.3 Prob. 7.9.6
<u>Steady Conduction (MQS or EQS)</u>		
Imposed Current:	Examp. 7.5.1	Probs. 7.5.1-2
<u>Magnetoquasistatic</u>		
Imposed Current:	Probs. 8.5.1-2	Examp. 8.5.1
Perfect Conductor:	Probs. 8.4.2-3	Examp. 8.4.3 Prob. 8.4.1
Magnetization:	Probs. 9.6.3-4,10,12	Probs. 9.6.11,13
Magnetic Diffusion:	Examp. 10.4.1	Probs. 10.4.3-4
	Probs. 10.4.5-6	

TM and TE Fields with Longitudinal Boundary Conditions. The case studies under this heading in Table 15.1.4 offer the opportunity to see the relationship

TABLE 15.1.4. SPECIAL CONFIGURATIONS	
<u>Fields Between Plane Parallel Plates</u>	
Capacitor:	Examps. 3.3.1, 6.3.3 Probs. 6.5.1-4, 6.6.8, 11.2.1 11.3.3, 11.6.1
Resistor:	Examps. 7.2.1, 7.5.2
Inductor:	Examp. 8.4.4, Probs. 9.5.1,3,6
Charge Relaxation:	Examp. 7.9.2
Magnetic Diffusion though:	
Thin Conductors:	Prob. 10.3.4
Thick Conductors (TEM):	Examps. 10.6.1, 10.7.1 Probs. 10.3.4, 10.6.1-2, 10.7.1-2
Principle (TEM) Waveguide Modes	Examps. 13.1.1-2
Transmission Line:	Examps. 14.1.1, 14.8.2
<u>Axisymmetric (Coaxial) Fields</u>	
Capacitor:	Probs 6.5.5-6
Resistor:	Examps. 7.5.2 Probs. 7.2.1,4,8
Inductor:	Examp. 3.4.1 Probs. 9.5.2,4-5
Charge Relaxation:	Prob. 7.9.1
TEM Transmission Line	Prob. 13.1.4
<u>TM and TE Fields with Longitudinal Boundary Conditions</u>	
Capacitive Attenuator:	Sec. 5.5
TM Waveguide Fields:	Examp. 13.3.1
Inductive Attenuator:	Examp. 8.6.3
TE Waveguide Fields:	Examp. 13.3.2
<u>Cylindrical Conductor-Pair and Conductor-Plane</u>	
EQS Perfect Conductors:	Examp. 4.6.3
MQS Perfect Conductors:	Examp. 8.6.1
TEM Transmission Line:	Examp. 14.2.2

between fields and their sources, in the quasistatic limits and as electromagnetic waves. The EQS and MQS limits, illustrated by Demonstrations 5.5.1 and 8.6.2, respectively, become the shorted TM and TE waveguide fields of Demonstrations 13.3.1 and 13.3.2.

Cylindrical Conductor Pair and Conductor Plane. The fields used in these configurations are first EQS, then MQS, and finally TEM. The relationship between the EQS and MQS fields and the physical world is illustrated by Demonstrations 4.7.1 and 8.6.1. Regardless of cross-sectional geometry, TEM waves on pairs of perfect conductors are much of the same nature regardless of geometry, as illustrated by Demonstration 13.1.1.

15.2 MACROSCOPIC MEDIA

Source Representation of Macroscopic Media. The primary sources of the EQS electric field intensity were the unpaired and paired charge densities, respectively, describing the influence of macroscopic media on the fields through conduction and polarization (Chap. 6). Although in Chap. 8 the primary source of the MQS magnetic field due to conduction was the unpaired current density, in Chap. 9, magnetization was modeled as the result of orientation of permanent magnetic dipoles made up of a pair of magnetic charges, positive and negative. This is not the conventional way of introducing magnetization. However, the magnetic charge model made possible an analogy between polarization and magnetization that enabled us to introduce magnetization into the field equations by analogy to polarization. More conventional is the approach that treats magnetization as the result of circulating Ampèrian currents. The two approaches lead to the same final result, only the model is different. To illustrate this, let us rewrite Maxwell's equations (12.0.1)–(12.0.4) in terms of \mathbf{B} , rather than \mathbf{H}

$$\nabla \times \mathbf{E} = -\frac{\partial}{\partial t} \mathbf{B} \quad (1)$$

$$\nabla \times \frac{\mathbf{B}}{\mu_o} = \nabla \times \mathbf{M} + \mathbf{J}_u + \frac{\partial}{\partial t} \epsilon_o \mathbf{E} + \frac{\partial}{\partial t} \mathbf{P} \quad (2)$$

$$\nabla \cdot \epsilon_o \mathbf{E} = -\nabla \cdot \mathbf{P} + \rho_u \quad (3)$$

$$\nabla \cdot \mathbf{B} = 0 \quad (4)$$

Thus, if \mathbf{B} is considered to be the fundamental field variable, rather than \mathbf{H} , then the presence of magnetization manifests itself by the appearance of the term $\nabla \times \mathbf{M}$ next to \mathbf{J}_u in Ampère's law. Like \mathbf{J}_u , the Ampèrian current density, $\nabla \times \mathbf{M}$, is the source responsible for driving \mathbf{B}/μ_o . Because \mathbf{B} is solenoidal, no sources of divergence appear in Maxwell's equations reformulated in terms of \mathbf{B} . The fundamental source representing magnetization is now a current flowing around a small loop (magnetic

dipole). Equations (1)–(4) are, of course, identical in content to (12.0.1)–(12.0.4) because they resulted from the latter by a simple substitution of $\mathbf{B}/\mu_o - \mathbf{M}$ for \mathbf{H} . Yet the model of magnetization was changed by this substitution. As mentioned in Sec. 11.8, both models lead to the same result even when relativistic effects are included, but the Ampèrian model calls for greater care and sophistication, because it contains moving parts (currents) in the rest frame. This is the other reason we chose the magnetic charge model extensively developed by L. J. Chu.

Material Idealizations. Much of our analysis of electromagnetic fields has been based on source idealizations. In the case of sources produced by or induced in media, idealizations were made of the media and of the boundary conditions implied by the induced sources. These are summarized by the first and second parts of Table 15.2.1.

The case studies listed in Tables 15.1.2–15.1.4 can be used as themes to exemplify these idealizations.

The Relativity of Perfection. We began modeling EQS and MQS fields in the presence of media by postulating “perfect” conductors. When we studied materials in more detail, we learned that “perfection” is a relative concept. Useful as are the idealizations summarized in Table 15.2.1, they must be used with proper regard for the approximations made. Those idealizations that involve conductivity depend not only on relative material properties for their validity but on size and time-rates of change as well. These are reviewed in the next section.

In each of the three “infinite parameter” idealizations listed in the table, the parameter in one region is large compared to that in another region. The appropriate boundary condition depends on the region of field excitation. The idealization makes it possible to approximate the field in an “inside” region without regard for what is “outside.” One of the continuity conditions on the surface of the “inside” region is approximated as being homogeneous. Then the fields in the “outside” region are found by starting with the other continuity condition. Our first introduction to this “inside-outside” approach came in Sec. 7.5. With appropriate regard for replacing a source of curl with a source of divergence, the general discussion given in Sec. 9.6 for magnetizable materials is applicable to the other situations as well.

15.3 CHARACTERISTIC TIMES, PHYSICAL PROCESSES, AND APPROXIMATIONS

Self-Consistency of Approximate Laws. By dealing with EQS and MQS systems, we concentrated on phenomena that result from approximate forms of Maxwell’s equations. Terms in the “exact” equations were ignored, and field configurations were derived from these truncated forms of the equations. This way of solving problems is not unique to electromagnetic field theory. Very often it is

TABLE 15.2.1 IDEALIZATIONS		
Idealization	Source Constraint	Section
EQS Perfect Insulator	Charges Constrained	4.3-5
Perfectly Polarized	\mathbf{P} Constrained	6.3
MQS Perfect “Insulator”	Currents Constrained	8.1-3
Perfectly Magnetized	\mathbf{M} Constrained	9.3
Resonant/Traveling-Wave Electrodynamic Systems	Self-Consistent Charge and Current	12.2-4, 12.6
Idealization	Boundary Condition	Section
EQS Perfect Conductor	Perfectly Conducting Surfaces Equipotentials	4.6-7, 5.1-10
Steady Conduction “Infinite Conductivity”	$\mathbf{n} \times \mathbf{E} \approx 0$ or $\mathbf{n} \cdot \mathbf{J} \approx 0$ on surface	7.2, 9.6
“Infinite” Permittivity	$\mathbf{n} \times \mathbf{E} \approx 0$ or $\mathbf{n} \cdot \mathbf{D} \approx 0$ on surface	9.6
“Infinite” Permeability	$\mathbf{n} \times \mathbf{H} \approx \mathbf{K}$ or $\mathbf{n} \cdot \mathbf{B} \approx 0$ on surface	9.6
MQS Perfect Conductor	$\partial \mathbf{n} \cdot \mathbf{B} / \partial t \approx 0$ on perfectly conducting surfaces	8.4, 8.6 10.1, 12.7 13.1-4

necessary to ignore terms that appear in a “more exact” formulation of a physical problem. When this is done, it is necessary to be fully cognizant of the consequences of such approximations. Thus, the energy conservation relations used in the EQS and MQS approximations are special limiting cases of the Poynting theorem obeyed by the full Maxwell equations. The neglect of the displacement current or magnetic induction is equivalent to the neglect of the electric or magnetic energy storage.

Next, one needs to ascertain whether the problem has been sufficiently specified by the approximate form of the equations and which boundary conditions have to be retained, which discarded. The development of the EQS and MQS approximations, with the proof of the uniqueness theorem, provided examples of the development of a self-consistent formalism within the framework of a set of approximate equations. In systems composed of “perfectly conducting” and “perfectly insulating” media, it is relatively easy to decide whether or not there are subsystems that are EQS or MQS.

A system of perfect conductors surrounded by perfect insulators is likely to be EQS, if it is “open circuit” at zero frequency (a system of capacitors), and MQS, if it is “short circuit” at zero frequency (a system of inductors). However, we are generally not confronted with physical situations in which the materials are labeled as “perfect conductors” or “perfect insulators.” Indeed, with the last half of Chap. 7 and Chap. 10 as background, there comes an awareness that in EQS and MQS systems the term “perfect” usually has very different meanings.

Presented with a physical object connected to an electrical source, how do we sort the dominant from the inconsequential electromagnetic phenomena? Generally, this is an iterative process with the first “guess” based on experience and intuition. With the understanding that the combinations of materials and geometries that are of practical interest are far too diverse to make a few simple rules universally applicable, this section is nevertheless aimed at organizing what we have learned so as to promote the insight required to identify dominant physical processes.

From the examination of how finite conductivity influences the distribution of the charge density in the EQS systems of Chap. 7 and the current density in the MQS systems of Chap. 10, and from the discussion of the electrodynamics of lossy materials, we have a good idea of what questions must be asked to determine the electromagnetic nature of simple subsystems. A specific example, familiar from Sec. 14.8, is the conducting block sandwiched between perfectly conducting plane parallel electrodes, shown in Fig. 14.8.1.

- First, what are the electrical properties of the materials? Here this question has been reduced to, What are σ , ϵ , and μ ? The most widely ranging of these parameters is the conductivity σ , which can vary from 10^{-14} S/m in common hydrocarbon liquids to almost 10^8 S/m in copper. Indeed, vacuum and superconducting materials extend this range from absolute zero to infinity.
- Second, what is the size scale l ? In common engineering systems, lengths of interest range from the submicrometer scales of semiconductor junctions to lengths for power transmission systems in excess of 1000 kilometers. Of course, even this range is small compared to the subnuclear to supergalactic range provided by nature.
- Third, what time scale τ is of interest? Perhaps the system is driven by a sinusoidally varying source. Then, the time scale would most likely be the reciprocal of the angular frequency $1/\omega$. In common engineering practice, frequencies range from 10^{-2} Hz used to characterize insulation to optical frequencies in the range of 10^{15} Hz. Again, nature provides frequencies that range even more widely, including the reciprocal of millions of years for terrestrial magnetic fields in one extreme and the frequencies of gamma rays in the other.

Similitude and Maxwell's Equations. Consider an arbitrary system, shown in Fig. 15.3.1, having the typical length l and properties

$$\epsilon\epsilon(\mathbf{r}), \quad \sigma\sigma(\mathbf{r}), \quad \mu\mu(\mathbf{r}) \quad (1)$$

where ϵ, σ , and μ are typical magnitudes of dielectric constant, conductivity and permeability, and $\epsilon(\mathbf{r}), \sigma(\mathbf{r})$, and $\mu(\mathbf{r})$ are the spatial distributions, normalized so that their peak values are of the order of unity.

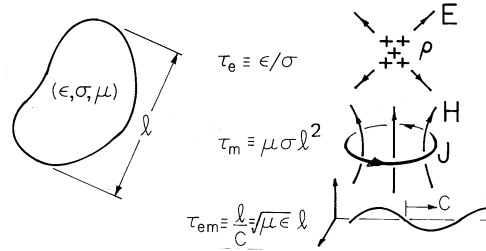

Fig. 15.3.1 Arbitrary system having typical length l , permittivity ϵ , conductivity σ , and permeability μ .

TABLE 15.3.1 SECTIONS EXEMPLIFYING CHARACTERISTIC TIMES	
Electroquasistatic charge relaxation time:	Sec. 7.7, 7.9
Magnetoquasistatic magnetic (current) diffusion time:	Sec. 10.2-7
Electromagnetic wave transit time:	Sec. 12.2-7, 14.3-4

From our studies of ohmic conductors in EQS and MQS systems, we know that field distributions are governed by the charge relaxation time τ_e and the magnetic diffusion time τ_m , respectively. Moreover, from our study of electromagnetic waves, we know that the transit time for an electromagnetic wave, τ_{em} , comes into play with electrodynamic effects. Sections in which these three times were exemplified are listed in Table 15.3.1. Thus, we expect to find that in systems having one typical size scale, there are no more than three times that determine the nature of the fields.

$$\tau_e \equiv \frac{\epsilon}{\sigma}; \quad \tau_m \equiv \mu\sigma l^2; \quad \tau_{em} \equiv \frac{l}{c} = l\sqrt{\mu\epsilon} \quad (2)$$

Actually, the electromagnetic transit time is the geometric mean of the other two times, so that only two of these times are independent.

$$\tau_{em} = \sqrt{\tau_e \tau_m} \quad (3)$$

With an excitation having the angular frequency ω , the relative distribution of sources and fields in a system is determined by the product of ω and any pair of these times. This can be seen by writing Maxwell's equations in normalized form. To that end, we use underbars to denote normalized (dimensionless) variables and normalize the spatial coordinates to the typical length l . The time is normalized to the reciprocal of the angular frequency.

$$(x, y, z) = (\underline{x}l, \underline{y}l, \underline{z}l), \quad t = \underline{t}/\omega \quad (4)$$

The fields and charge density are normalized to a typical electric field intensity \mathcal{E} .

$$\mathbf{E} = \mathcal{E}\underline{\mathbf{E}}, \quad \mathbf{H} = \mathcal{E}\sqrt{\frac{\epsilon}{\mu}}\underline{\mathbf{H}}, \quad \rho_u = \frac{\epsilon\mathcal{E}}{l}\rho_u \quad (5)$$

Then, Maxwell's equations (12.0.7)–(12.0.10), with the constitutive laws of (1), become

$$\underline{\nabla} \cdot \epsilon\underline{\mathbf{E}} = \rho_u \quad (6)$$

$$\underline{\nabla} \times \underline{\mathbf{H}} = \omega\tau_{em}\left(\frac{1}{\omega\tau_e}\underline{\mathbf{E}} + \frac{\partial\epsilon\underline{\mathbf{E}}}{\partial t}\right) \quad (7a)$$

$$= \frac{1}{\omega\tau_{em}}\omega\tau_m\underline{\mathbf{E}} + \omega\tau_{em}\frac{\partial\epsilon\underline{\mathbf{E}}}{\partial t} \quad (7b)$$

$$\underline{\nabla} \times \underline{\mathbf{E}} = -\omega\tau_{em}\frac{\partial\underline{\mathbf{H}}}{\partial t} \quad (8)$$

$$\underline{\nabla} \cdot \mu\underline{\mathbf{H}} = 0 \quad (9)$$

In writing the alternative forms of Ampère's law, (3) has been used.

In a system having the constitutive laws of (1), two parameters specify the fields predicted by Maxwell's equations, (6)–(9). These are any pair of the three ratios of the characteristic times of (2) to the typical time of interest. For the sinusoidal steady state, the time of interest is $1/\omega$. Thus, using the version of Ampère's law given by (7a), the dimensionless parameters $(\omega\tau_{em}, \omega\tau_e)$ specify the fields. Using (7b), the parameters are $(\omega\tau_{em}, \omega\tau_m)$.

Characteristic Times and Lengths. Evidently, the three dimensionless parameters formed by multiplying the characteristic times of (2) by the frequency, ω , (or the reciprocal of some other time typifying the dynamics), are the key to sorting out physical processes.

$$\omega\tau_e = \frac{\omega\epsilon}{\sigma}; \quad \omega\tau_m = \omega\mu\sigma l^2; \quad \omega\tau_{em} = \omega l\sqrt{\mu\epsilon} \quad (10)$$

Given two of these parameters and hence the third, we have some clues as to what physical processes are dominant. However, even in a subsystem typified by one permittivity, one conductivity, and one permeability, other parameters may be needed to specify the geometry. Every ratio of dimensions is another dimensionless parameter! To begin with, suppose that we are dealing with a system where all of the dimensions are on the order of the typical length l . The characteristic times make evident why quasistatic systems are either EQS or MQS. They also determine how the effects of finite conductivity come into play either through charge relaxation or magnetic diffusion as the frequency is raised.

Since the electromagnetic transit time is the geometric mean of the charge relaxation and magnetic diffusion times, (3), τ_{em} must lie between the other two times. Thus, the three times are in one of two orders. Either $\tau_m < \tau_e$, in which case

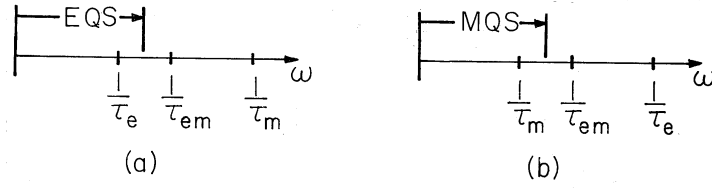

Fig. 15.3.2 Ordering of reciprocal of characteristic times on the frequency axis.

the order of reciprocal times is as shown in Fig. 15.3.2a, or the reverse is true, and the order is as in Fig. 15.3.2b. Moreover, if τ_e is well removed from τ_{em} , then we are assured that τ_m is also very different from τ_{em} .

As the frequency is raised, we first encounter either the charge relaxation phenomena typical of EQS subsystems (Fig. 15.3.2a) or the magnetic diffusion phenomena of MQS subsystems (Fig. 15.3.2b). The respective quasistatic laws for EQS and MQS systems apply for frequencies ranging above the first reciprocal time but below the reciprocal electromagnetic transit time. In both cases, the frequency is well below the reciprocal of the electromagnetic delay time.

The EQS laws follow from (6)–(9) using the first form of (7). A physical situation is characterized by the EQS laws, when the term on the right hand side of Faraday's law, (8), is negligible. From Ampère's law we gather that \mathbf{H} is of the order of $\omega\tau_{em}\mathbf{E}$ when $\omega\tau_e > 1$, and of order τ_{em}/τ_e when $\omega\tau_e < 1$. In the former case, in which the displacement current density dominates over the conduction current density, one finds for the right hand side in Faraday's law: $(\omega\tau_{em})^2\mathbf{E}$. In the latter case, in which the conduction current density is larger than the displacement current density, the right hand side of (8) is $\omega\tau_{em}^2/\tau_e\mathbf{E}$. Thus the source of curl in Faraday's law can be neglected when $(\omega\tau_{em})^2 \ll 1$ or $\omega\tau_{em}/\tau_e \ll 1$ whichever is a more stringent limit on ω . The laws of EQS prevail. An analogous, but simpler, argument arrives at the laws of MQS. The argument is simpler, because there is no analog to unpaired electric charge.

In cases where the ordering of characteristic times is as in Fig. 15.3.2b, the MQS laws apply for frequencies beyond the reciprocal magnetic diffusion time but again falling short of the electromagnetic transit time. This can be seen from the normalized Maxwell's equations, this time using (7b). Because $\omega\tau_{em} \ll 1$, the last term in (7b) (the displacement current) is negligible. Thus, we are led to the primary MQS laws, Ampère's law with the displacement current neglected and the continuity law for the magnetic flux density (9). This time, it follows from Ampère's law [(7b) with the last term neglected] that $\mathbf{H} \approx (\omega\tau_m/\omega\tau_{em})\mathbf{E}$, so that the right-hand side of Faraday's law, (8), is of the order of $\omega\tau_m$. Thus, the MQS laws are (10.0.1)–(10.0.3).

As the frequency is raised, so that we move from left to right along the frequency axes of Fig. 15.3.2, we expect dynamical phenomena associated with charge relaxation, electromagnetic waves, and magnetic diffusion to come into play as the frequency comes into the range of the respective reciprocal characteristic times. Actually, because the dynamics can establish their own length scales (for example, the skin depth), matters are sometimes not so simple. However, insight is gained by observing that the length scale l orders these critical frequencies. With the objective of picturing the electromagnetic phenomena in a plane, in which one axis reflects the effect of the frequency while the other axis represents the length scale,

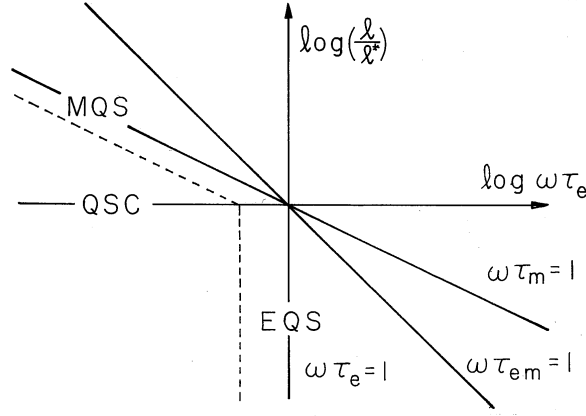

Fig. 15.3.3 In plane where the vertical axis denotes the log of the length scale normalized to the characteristic length defined by (14), and the horizontal axis is the angular frequency multiplied by the charge relaxation time, τ_e , the three lines denote possible boundaries between regimes.

we normalize the frequency to the one characteristic time, τ_e , that does not depend on the length. Thus, the frequency conditions for effects of charge relaxation, magnetic diffusion, and electromagnetic waves to be important are, respectively,

$$\omega\tau_e = 1 \quad (11)$$

$$\omega\tau_m = 1 \Rightarrow \omega\tau_e = (l/l^*)^{-2} \quad (12)$$

$$\omega\tau_{em} = 1 \Rightarrow \omega\tau_e = (l/l^*)^{-1} \quad (13)$$

where the *characteristic length* l^* is

$$l^* \equiv \frac{1}{\sigma} \sqrt{\epsilon/\mu} \quad (14)$$

In a plane in which the coordinates are essentially the length scale and the frequency, the lines along which the frequency is equal to the respective reciprocal characteristic times are shown in Fig. 15.3.3. The vertical axis denotes the log of the length scale normalized to the characteristic length, while the horizontal axis is the log of the frequency multiplied by the charge relaxation time. Thus, the origin is where the length is equal to l^* and the frequency is equal to $1/\tau_e$.

Note that for systems having a typical length l less than the reciprocal of the characteristic impedance conductivity product, l^* , the ordering of times is as in Fig. 15.2.1a. If the length is greater than this characteristic length, then the ordering is as in Fig. 15.2.1b. At least for systems having one length scale l and one characteristic time $1/\omega$, *the system can be MQS only if l is larger than l^* and can be EQS only if l is smaller than l^** . The MQS and EQS regimes of Fig. 15.3.3 both reduce to quasistationary conduction (QSC) at frequencies such that $\omega\tau_m \ll 1$ and $\omega\tau_e \ll 1$, respectively.

Since σ is such a widely varying parameter, the values of l^* also have a wide range. Table 15.3.2 illustrates this fact. In water having physiological conductivity

(in flesh), the characteristic times would coincide if the length scale were about 12 cm at a characteristic frequency ($\omega\tau_e = 1$) $f = 45$ MHz. For lengths less than about 12 cm, the ordering would be as in Fig. 15.3.2a and for longer lengths, as in Fig. 15.3.2b. However, in copper it would require that the characteristic length be less than an atomic distance to make τ_e exceed τ_m . On such a short length scale, the conductivity model is not valid.¹ In the opposite extreme, a layer of corn oil about 60,000 miles thick would be required to make τ_m exceed τ_e !

Example 15.3.1. Overview of TEM Fields in Open Circuit Transmission Line Filled with Lossy Material (continued)

In Sec. 14.8, we considered the nature of the electromagnetic fields in a conductor sandwiched between “perfectly conducting” plates. Example 14.8.2 was devoted to an overview of electromagnetic regimes pictured in the length-time plane, Fig. 14.8.3, redrawn as Fig. 15.3.3. As the frequency was raised in that example with $l \gg l^*$, the line $\omega\tau_m = 1$ indicated that quasi-stationary conduction had given way to magnetic diffusion (the resistor had become a system of distributed resistors and inductors). In that specific example, this was the line at which the long wave approximation broke down, $\beta l \approx 1$. With $l \ll l^*$, we have seen that as the frequency was raised, the crossing of the line $\omega\tau_e = 1$ denoted that a resistor had changed into a system of distributed resistors in parallel with distributed capacitors.

This example has a misleading simplicity that can be traced to the fact that it actually possesses more than one length scale and conductivity. To impose the TEM fields by means of the source, it was necessary to envision the slab of conductor as making perfect electrical contact with perfectly conducting plates. In reality, the boundary condition used to represent these plates implies conditions on still other parameters, notably the electrical properties and thickness of the plates.

As the frequency is raised for a system in the upper half-plane (l larger than the matching length), why do we not see a transition to electromagnetic waves at $\omega\tau_{em} = 1$ rather than $\omega\tau_e = 1$? The perfectly conducting plates force the displacement current to compete with the conduction current on its “own” length scale (either the skin depth or the electromagnetic wavelength). Thus, in this example, we do not make a transition from magnetic diffusion (with a penetration length determined by the skin depth δ) to a damped electromagnetic wave (with a decay length of twice l^*) until the electromagnetic wavelength $\lambda = 2\pi/\sqrt{\mu\epsilon}\omega$ has become as short as the skin depth. Both are decreasing with increasing frequency. However, the skin depth (which decreases as $1/\sqrt{\omega}$) is equal to the wavelength (which decreases as $1/\omega$) only as the frequency reaches $\omega\tau_e = 2\pi^2$ (for present purposes, “ $\omega\tau_e = 1$ ”).

In the lower half-plane, where systems are smaller than the characteristic length, why was the transition at $\omega\tau_e = 1$ evident in the surface current density in the plates but not in the spatial distribution of the fields? The electric field was found to remain uniform until the frequency had been raised to $\omega\tau_{em} = 1$. Here again, the “perfectly conducting” plates obscure the general situation. The conducting block has uniform conductivity. As a result, it can support no volume charge density, regardless of the frequency. In the EQS limit, it is the charge density that shapes the electric field distribution. Here the only charges are at the interfaces between the block and the perfectly conducting plates. Until magnetic induction comes into play at $\omega\tau_{em} = 1$, these surface charges assume whatever distribution they must

¹ Put another way, on a time scale as short as the charge relaxation time in a metal, the inertia of the electrons responsible for the conduction would come into play. (S. Gruber, “On Charge Relaxation in Good Conductors,” *Proc. IEEE*, Vol. 61 (1973), pp. 237-238. The inertial force is not included in the conductivity model.

to be consistent with an irrotational electric field. As a result, the plates make the EQS fields essentially uniform, and the appropriate model simplifies to one lumped parameter C in parallel with one lumped parameter R .

15.4 ENERGY, POWER, AND FORCE

Maxwell's equations attribute an excitation (\mathbf{E} and \mathbf{H}) to every point in space. Consistent with this view, energy density and power flow density must be associated with every point in space as well. Poynting's theorem, Sec. 11.2, does that. Poynting's theorem identifies energy storage and dissipation associated with the polarization and magnetization processes.

Each self-consistent macroscopic set of equations must possess an energy conservation principle, maybe including terms describing transformation of energy into other forms, like heat, if dissipation is present. An example was given in Sec. 11.3 of a conservation principle for the approximate description of EQS fields with a density of power flow vector that was different from $\mathbf{E} \times \mathbf{H}$. This alternate form of an energy conservation principle was better suited to the EQS description, because it did not contain the \mathbf{H} field which is not usually evaluated in the EQS approximation. Instead, the charge conservation law (derived from Ampère's law) was used to find the currents flowing in the system.

An important application of the concept of energy was the derivation of the force on macroscopic material. The force on a dielectric or magnetic object computed from energy change can include correctly the contributions to the net force from fringing fields even though the field expressions neglect them, if the energy associated with the fringing field does not change in a small displacement of the object.

Energy and Quasistatics. Because magnetic and electric energy storages, respectively, are negligible in EQS and MQS systems, a comparison of energy densities can also be used to establish the validity of a quasistatic approximation. Specifically, we will see that in systems characterized by one length scale, the ratio of magnetic to electric energy storage takes the form

$$\frac{w_m}{w_e} = K \left(\frac{l}{l^*} \right)^2 \quad (1)$$

where l^* is the characteristic length

$$l^* \equiv \frac{1}{\sigma} \sqrt{\epsilon/\mu} \quad (2)$$

familiar from Secs. 14.8² and 15.3 and K is of the order of unity.

² In Sec. 14.8, twice this length was found to be the decay length for an electromagnetic wave.

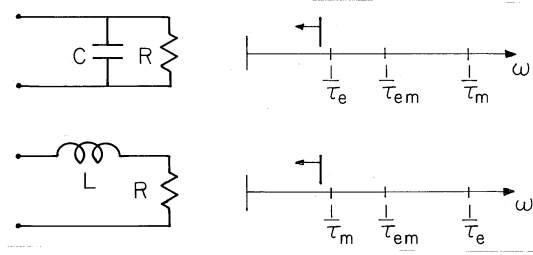

Fig. 15.4.1 Low-frequency equivalent circuits and associated ordering to reciprocal times.

Energy arguments can also be the basis for simple models that modestly extend the frequency range of quasi-stationary conduction. A second object in this section is the illustration of how these models are deduced.

As the frequency is raised, one of two processes leads to a modification in the field sources, and hence of the fields. If l is less than l^* , so that $1/\tau_e$ is the first reciprocal characteristic time encountered as ω is raised, then the current density is progressively altered to supply unpaired charge to regions of nonuniform σ and ϵ . Alternatively, if l is larger than l^* , so that $1/\tau_m$ is the shortest reciprocal characteristic time, magnetic induction alters the current density not only in its magnitude and time dependence but in its spatial distribution as well.

Fully dynamic fields, in which all three (or more) characteristic times are of the same order of magnitude are difficult to analyze because the distribution of sources is not known until the fields have been solved selfconsistently, often a difficult task. However, if the frequency is lower than the lowest reciprocal time, the field distributions still approximate those for stationary conduction. This makes it possible to approximate the energy storages, and hence to identify both the conditions for the system to be EQS or MQS and to develop models that are appropriate for frequencies approaching the lowest reciprocal characteristic time.

The first step in this process is to determine the quasi-stationary fields. The second is to use these fields to evaluate the total electric and magnetic energy storages as well as the total energy dissipation.

$$w_e = \int_V \frac{1}{2} \epsilon \mathbf{E} \cdot \mathbf{E} dv; \quad w_m = \int_V \frac{1}{2} \mu \mathbf{H} \cdot \mathbf{H} dv; \quad p_d = \int_V \sigma \mathbf{E} \cdot \mathbf{E} dv \quad (3)$$

If it is found that the ratio of magnetic to electric energy storage takes the form of (1), and that if l is either very small or very large compared to the characteristic length, then we can presumably model the system by either the R-C or the L-R circuit of Fig. 15.4.1.

As the third step, parameters in these circuits are determined by comparing w_e , w_m , and p_d , as found from the QSC fields using (3), to these quantities determined in terms of the circuit variables.

$$w_e = \frac{1}{2} C v^2; \quad w_m = \frac{1}{2} L i^2; \quad p_d = R i^2 \quad (4)$$

In general, the circuit models are valid only up to frequencies approaching, but not equal to, the lowest reciprocal time for the system. In the following example, we

will find that the R-C circuit is an exact model for the EQS system, so that the model is valid even for frequencies beyond $1/\tau_e$. However, because the fields can be strongly altered by rate processes if the frequency is equal to the lowest reciprocal time, it is generally not appropriate to use the equivalent circuits except to take into account energy storage effects coming into play as the frequency *approaches* $1/RC$ or R/L .

Example 15.4.1. Energy Method for Deriving an Equivalent Circuit

The block of uniformly conducting material sandwiched between plane parallel perfectly conducting plates, as shown in Fig. 14.8.1, was the theme of Sec. 14.8. This gives the opportunity to see how the low-frequency model developed here fits into the general picture provided by that section.

In the conducting block, the quasi-stationary conduction (QSC) fields have the distributions

$$\mathbf{E} = \frac{v}{a} \mathbf{i}_x; \quad \mathbf{H} = \frac{\sigma v}{a} z \mathbf{i}_y \quad (5)$$

The total electric and magnetic energies and total dissipation follow from an integration of the respective densities over the volume of the system in accordance with (3)

$$w_e = wal \frac{1}{2} \epsilon \frac{v^2}{a^2}; \quad w_m = \frac{wa\mu}{6} \left(\frac{\sigma v}{a} \right)^2 l^3; \quad p_d = \frac{a}{wl\sigma} i^2 \quad (6)$$

where v and i are the terminal voltage and current.

Comparison of (4) and (6) shows that

$$C = \frac{lw\epsilon}{a}; \quad L = \frac{a\mu l}{3w}; \quad R = \frac{a}{lw\sigma} \quad (7)$$

Because the entire volume of the system considered here has uniform properties, there are no sources of the electric field (charge densities) in the volume of the system. As a result, the capacitance C found here is no different than if the volume were filled with a perfectly insulating material. By contrast, if the slab were of nonuniform conductivity, as in Example 7.2.1, the capacitance, and hence equivalent circuit, found by this energy method would not be so "obvious."

The inductance of the equivalent circuit does reflect a distribution of the source of the magnetic field, for the current density is distributed throughout the volume of the slab. By using the energy argument, we have acknowledged that there is a distribution of current paths, each having a different flux linkage. Strictly, when the flux linked by any current path is the same, inductance is only defined for perfectly conducting current paths.

Which equivalent circuit is appropriate? Here we decide by comparing the stored energies.

$$\frac{w_m}{w_e} = \frac{1}{3} \left(\frac{l}{l^*} \right)^2 \quad (8)$$

Thus, as we anticipated with (1), the system can be EQS if $l \ll l^*$ and MQS if $l \gg l^*$. The appropriate equivalent circuit in Fig. 15.4.1 is the $R - C$ circuit if $l \ll l^*$ and is the $L - R$ circuit if $l \gg l^*$.

The simple circuits of Fig. 15.4.1 are not generally valid if the frequency reaches the reciprocal of the longest characteristic time, since the field distributions

have changed by then. In terms of the circuit elements, this means that in order for the circuits to be equivalent to the physical system, the time rates of change must remain slow enough so that $\omega RC < 1$ or $\omega L/R < 1$.

P R O B L E M S

15.1 Source and Material Configurations

15.1.1 A theme from Chap. 5 on has been the use of orthogonal modes to represent field solutions and satisfy boundary conditions. Make a table identifying examples and problems illustrating this theme.

15.2 Macroscopic Media

15.2.1 Field lines in the vicinity of a spherical interface between materials (a) and (b) are shown in Fig. P15.2.1. In each case, describe four idealized physical situations for which the field lines would be appropriate.

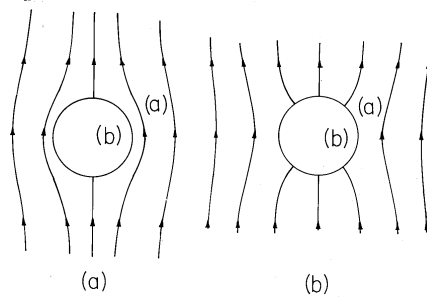

Fig. P15.2.1

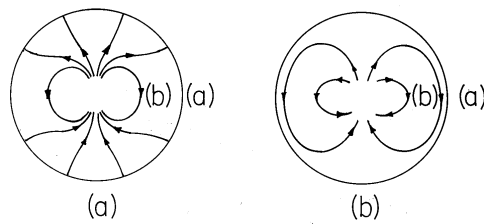

Fig. P15.2.2

15.2.2 Dipoles at the center of a spherical region and associated fields are shown in Fig. P15.2.2. In each case, describe four appropriate idealized physical situations.

15.3 Characteristic Times, Physical Processes, and Approximations

15.3.1 In Fig. 15.3.3, a typical length and time are considered the independent parameters. Suppose that we wish to see the effect of varying the conductivity with the size held fixed. For example, with not only the size but the frequency fixed, the material might be cooling from a very high temperature where it is molten and an ionic conductor to a low temperature where it is a good insulator. Using the conductivity rather than the length for the vertical axis, select a normalization time for the horizontal axis, and construct a diagram analogous to Fig. 15.3.3. Identify a “characteristic” conductivity, σ^* , for normalizing the conductivity.

15.3.2 Figure 7.5.3 shows a circular conductor carrying a current that is returned through a coaxial “perfectly” conducting “can.” For sufficiently low frequencies, the electric field and surface charge densities are as shown in Fig. 7.5.4. The magnetic field is described in Example 11.3.1 where the effect of the washer-shaped conductor is neglected.

- Sketch \mathbf{E} and \mathbf{H} , as well as the distribution of ρ_u and \mathbf{J}_u .
- Suppose that the length L is on the order of the radius (a), and (b) is not much smaller than (a). As the frequency is raised, argue that either charge relaxation will first dominate in revising the field distribution as in Fig. P15.3.2a, or magnetic diffusion will dominate as in Fig. P15.3.2b. In the latter case, describe the current distribution in the conductor by associating it with an example and a demonstration in this text.
- With L allowed to be large compared to (a), under what circumstances will the system behave as the lossy transmission line of Fig. 14.7.1 with $G = 0$? Discuss the EQS and MQS limits where this model applies.

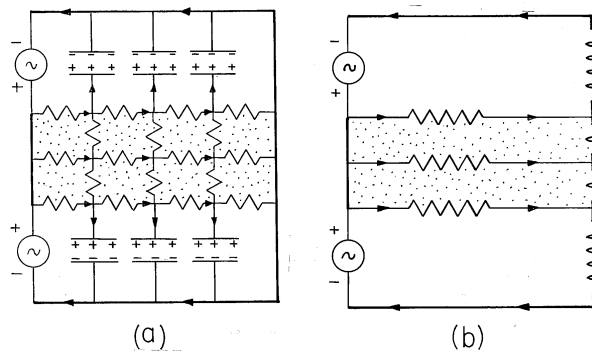

Fig. P15.3.2

15.4 Energy, Power, and Force

15.4.1 For the system considered in Prob. 15.3.2, use the energy approach to

identify the parameters in the low frequency equivalent circuits of Fig. 15.4.1, and write the ratio of energies in the form of (1). Ignore the effect of the washer-shaped conductor.