

USN Technology in Korea and R&D in Auto-ID Lab Korea

2005. 10. 14.

Sang-Gug Lee

Auto-ID Lab Korea in ICU



Information and Communications
University

- **RFID/USN in Korea**
 - IT839 Strategy
 - R&D Thrust towards u-Korea
 - Public USN Concept
 - USN Applications
 - USN Technology Tree
 - Roadmap for USN R&D

- **Auto-ID Lab Korea**
 - Theme and members
 - Research focus
 - On-going research
 - Objective

IT839 Strategy

A master plan for the IT industry, in an effort to gain more growth momentum from the IT sector in Korea.

Introducing and promoting 8 Services

- 2.3 GHz mobile **8**
Internet (WiBro)
- DMB service
- Home network service
- Telematics service
- **RFID** based service
- W-CDMA service
- DTV service
- VoIP service

Building 3 infrastructures

- 3**
- BcN
(Broadband Convergence Network)
- **USN**
(Ubiquitous Sensor Network)
- IPv6

Developing 9 IT New Growth Engine

- NG Mobile Phone **9**
- Digital TV
- Home Network
- IT SoC
- Post PC
- Embedded S/W
- Digital Contents
- Telematics
- Intelligent Robot

R&D Thrust towards u-Korea

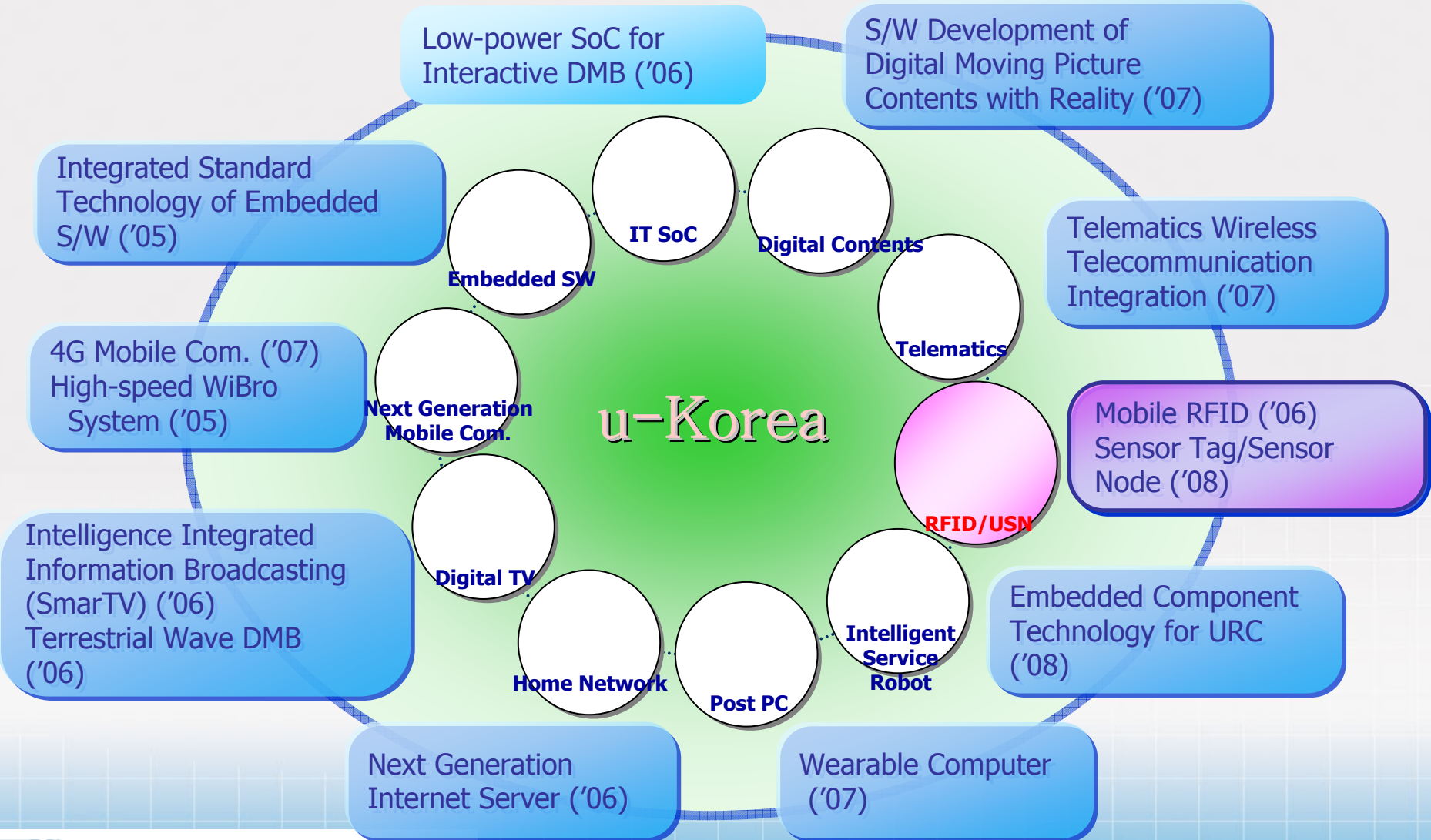

Public USN Concept



- Everywhere, everything with RFID tags
- Sensing ID and environmental information
- Real-time monitoring & control via network

Ubiquitous

Sensor

Network

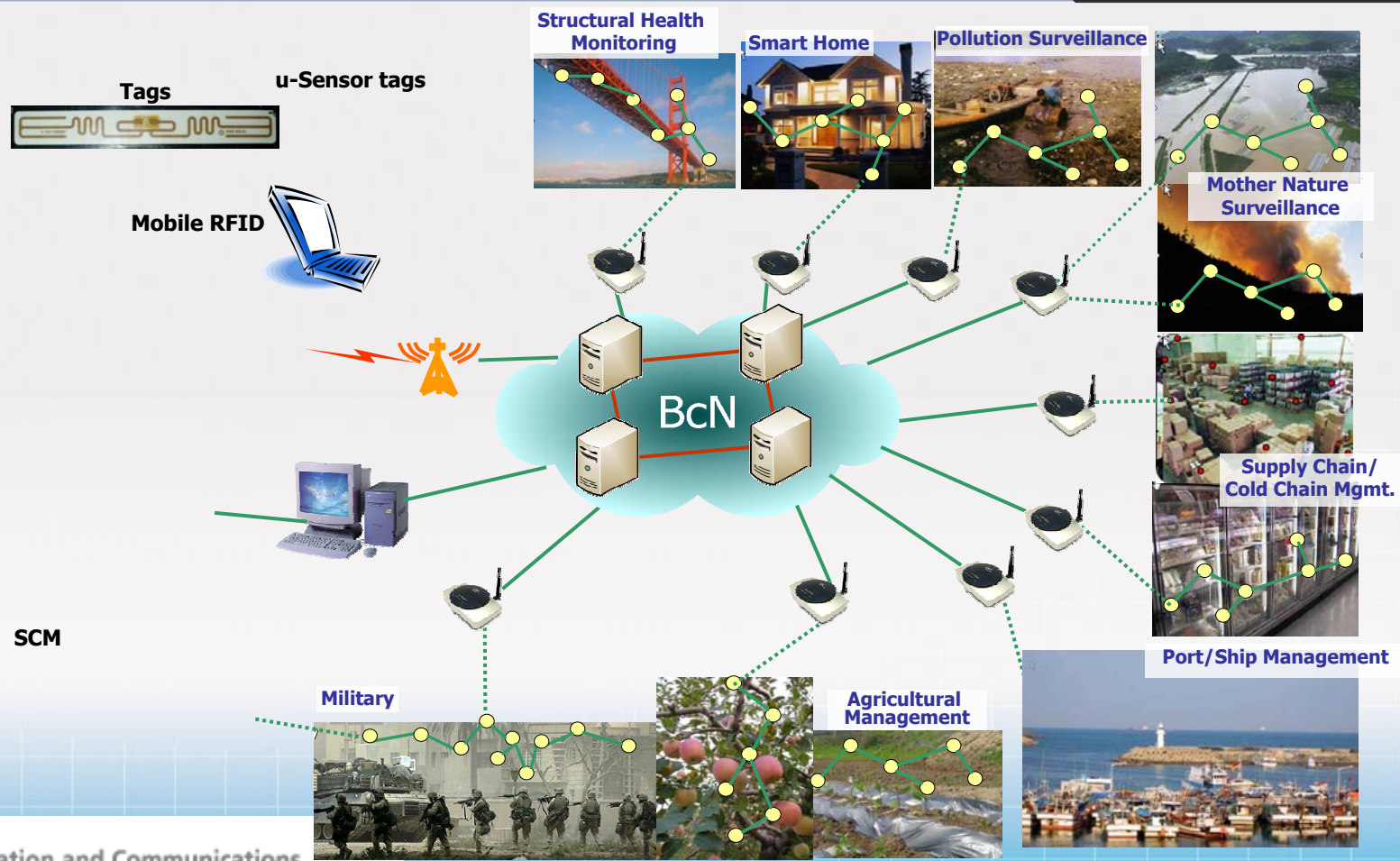

- ◆ Smart building
 - ❖ HVAC control
 - ❖ Lighting control
 - ❖ Intrusion Detection

- ◆ Factory automation & monitoring
 - ❖ Diagnosis (ex. Pole transformer monitoring)
 - ❖ Prognosis

- ◆ Asset Monitoring and Management
 - ❖ Inventory management
 - ❖ Cold-chain supply management

- ◆ Structural Health Monitoring
 - ❖ Cracks
 - ❖ Vibration

- ◆ Environmental Monitoring
 - ❖ Air pollution, earthquake
 - ❖ Traffic monitoring system
 - ❖ Ecological monitoring

USN Technology Tree



National Disaster Prevention and Countermeasure Headquarter

Services & Applications



USN Applications



USN Middleware & Service Platform

Infrastructure

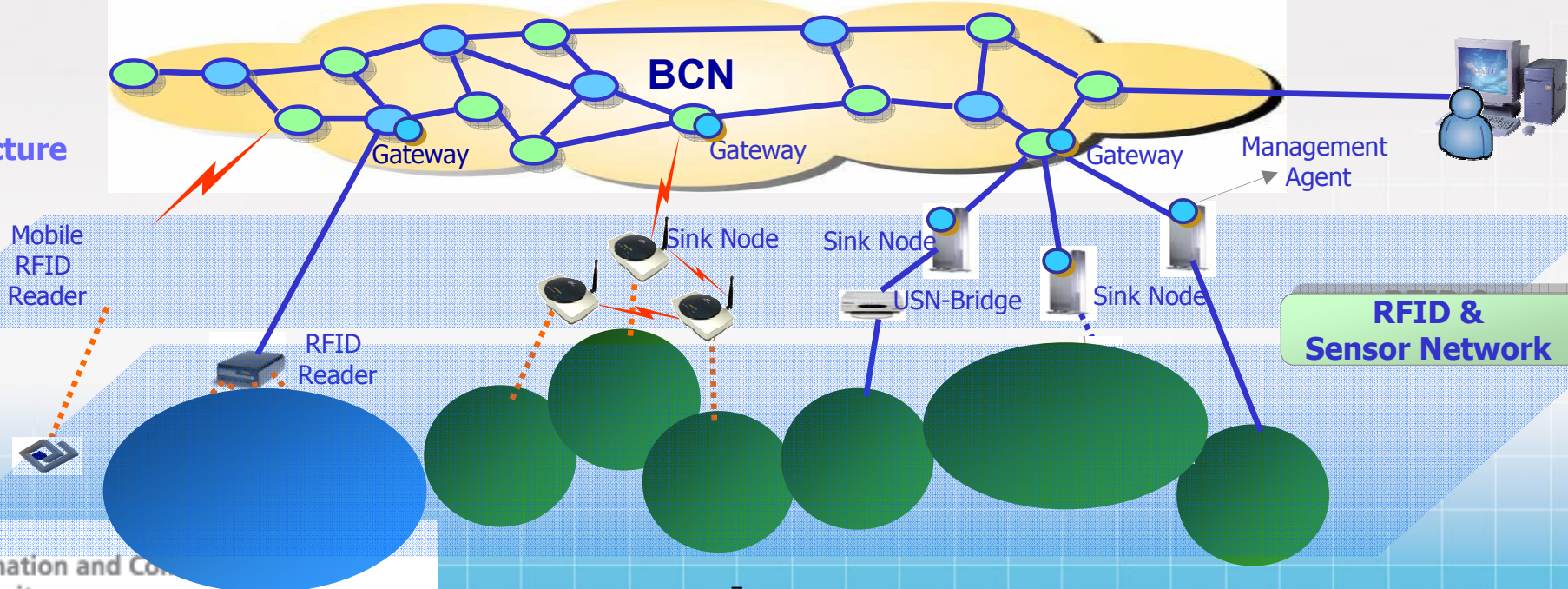

RFID & Sensor Network

Roadmap for USN R&D

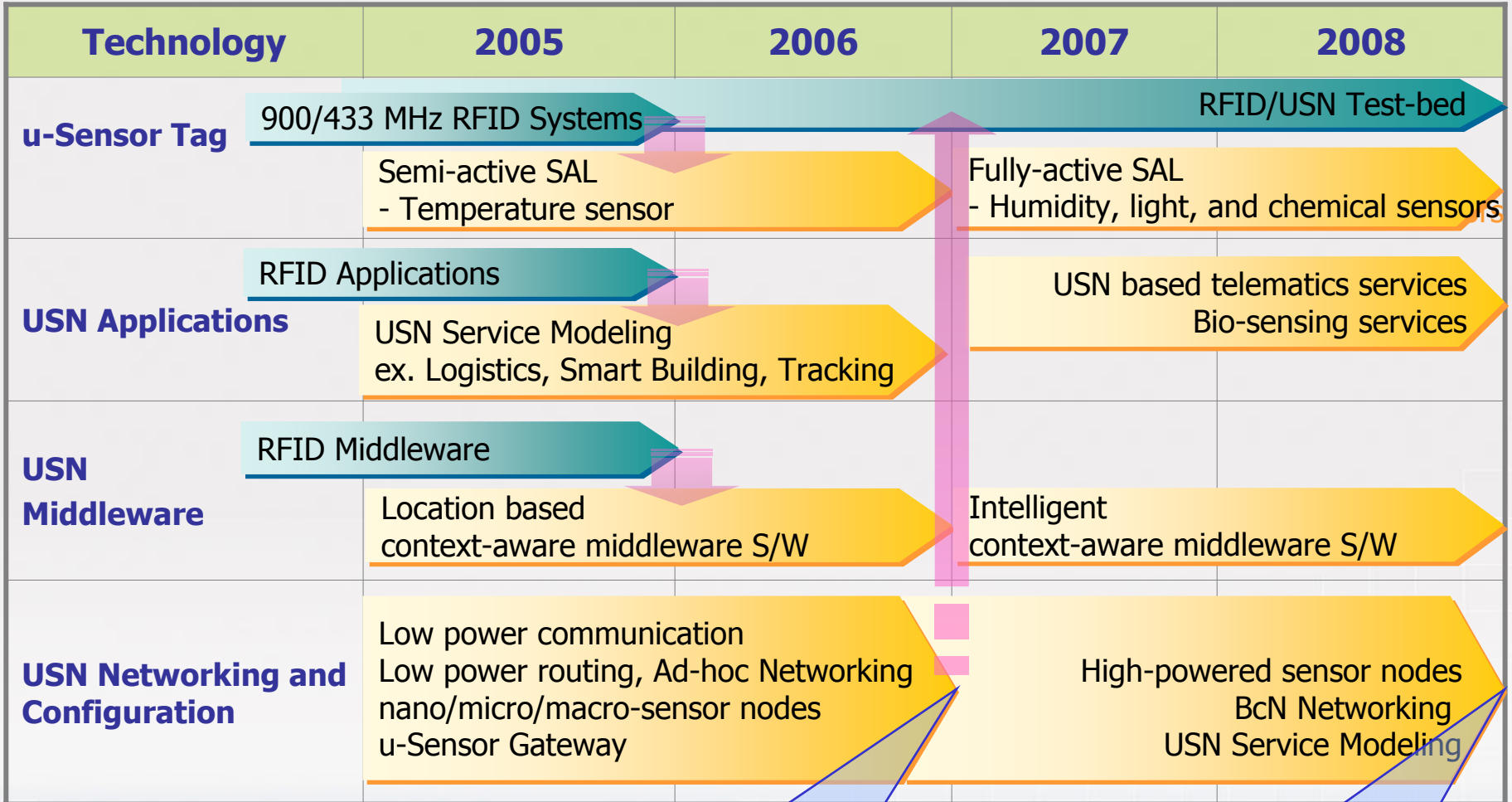

SoC node (MCU+MAC+RF)
Big Coin size
1,000+ node networking

Tiny nodes
Small Coin size
10,000+ node networking

Theme: EPC network based Sensor Network Technology

Members

Name	Position	Research Area
Sang-Gug Lee	Professor, Research Director	RF/analog chip design
Daeyoung Kim	Assistant Professor, Associate Research Director	Sensor network H/W & S/W, EPC middleware
Jae Jeong Rho	Associate Professor	Business model, SCM
Kwang Jo Kim	Professor	Cryptology and information security
Seong-Ook Park	Associate Professor	Antenna, microwave system
Hyuck Jae Lee	Professor	Anti-collision, communication system
Hyun Cheol Park	Associate Professor	Modem algorithm, base-band

Hardware and communication technology for EPC-based next generation USN

Hardware structure design, low power, high reliability air interface network protocol, etc. for the implementation of EPC class 2, 3, 4, and 5



Class 2,3,4,5 Tags

Middleware technology for EPC sensor network

Development of information expression/management structure of EPC class 2, 3, 4, and 5, internet-based real-time high capacity data search and processing technology

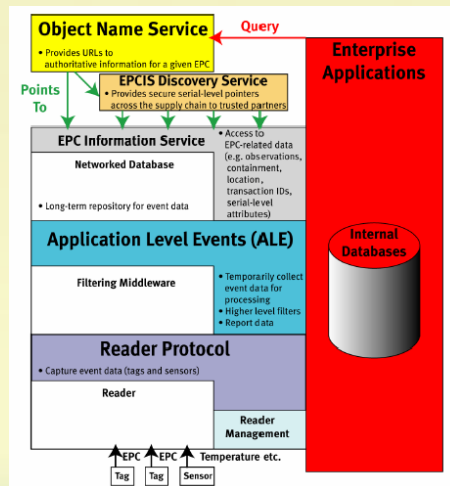

EPC Network Middleware

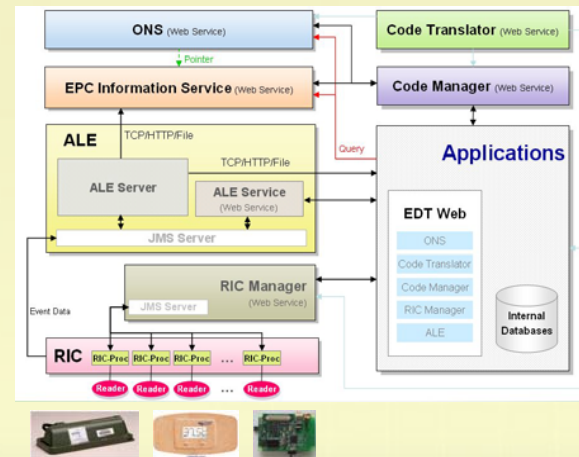

EPC Sensor Network Middleware

EPC RFID/USN security and privacy protection technology

Tag anti-counterfeiting and privacy protection, light weight cryptography for data security, key management and distribution, authentication protocol, etc.

Business Model Development Framework and Application Service Development for RFID/USN

Development of next generation standard-based application service business model framework

Air Interface for Ad-hoc Active Tags

IEEE 802.15.4a Impulse Radio Development

- Transceiver: Impulse radio chip
- Modem: synchronization algorithm
- MAC: ranging, localization

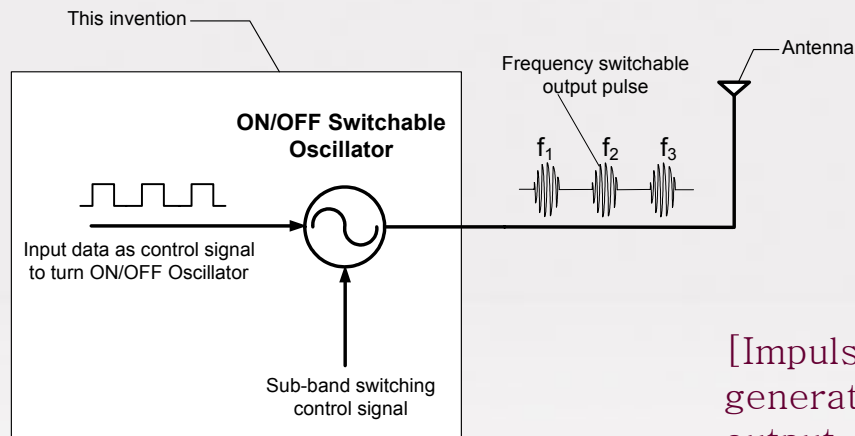

[Low power impulse generator]

[Impulse generator output spectrum]

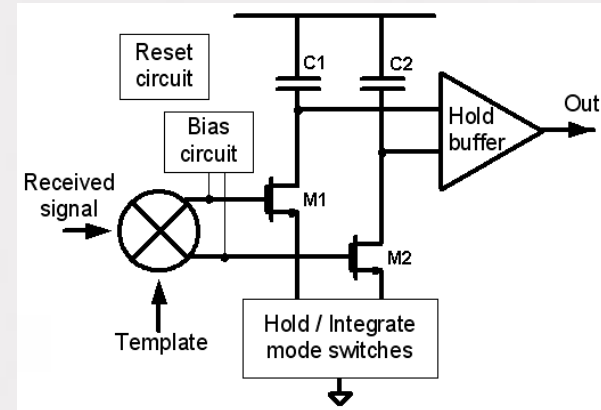

[Low power correlator]

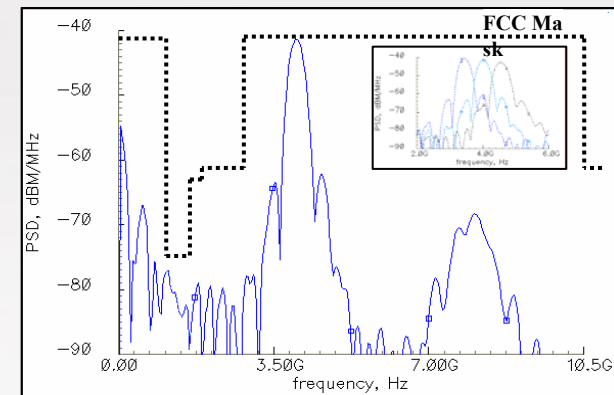

Reactive u-Radio Technology

- Radio-based wake-up circuits, low power MAC/network

EPC Sensor Network Middleware Architecture

◆ Based on EPC Architecture Framework

Can EPC Architecture Framework support class 3,4,5?

Changes will be required !!

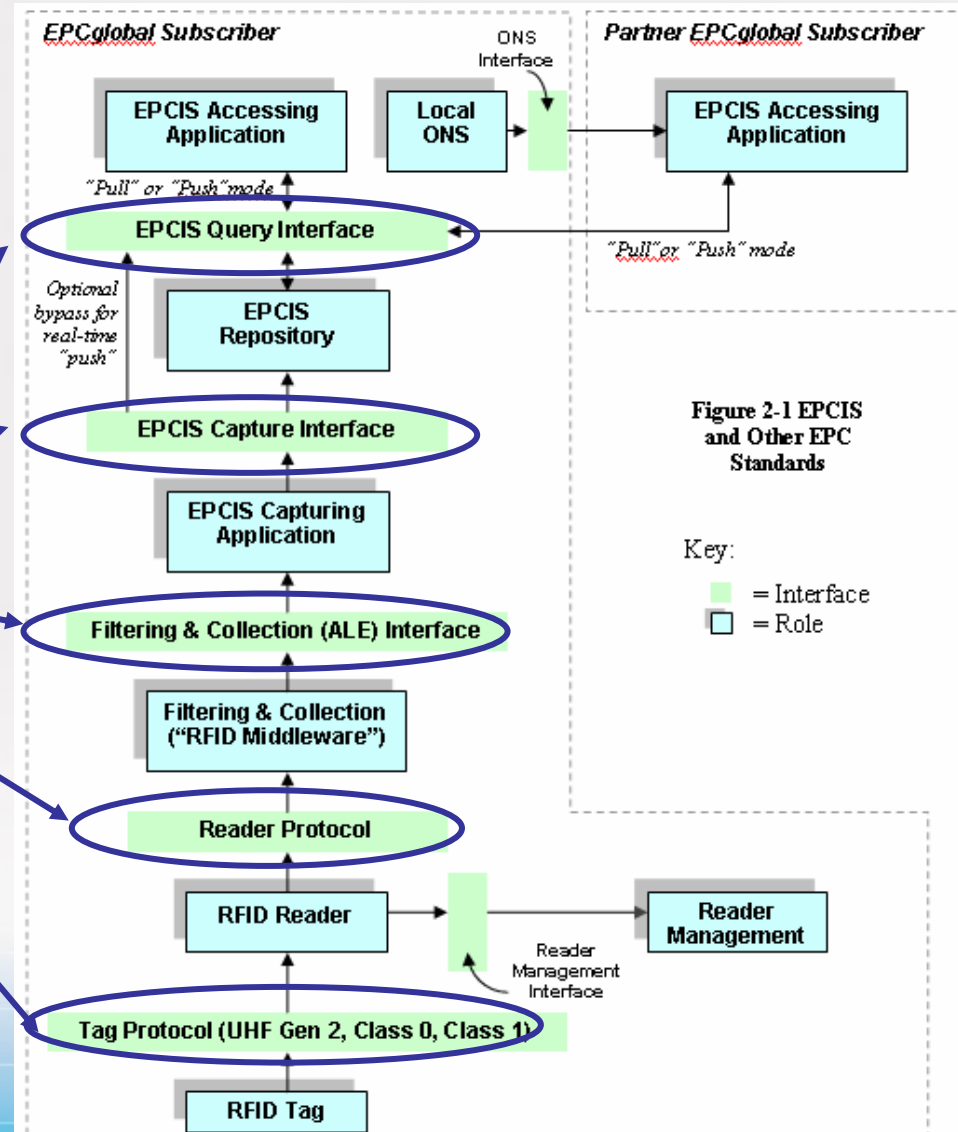
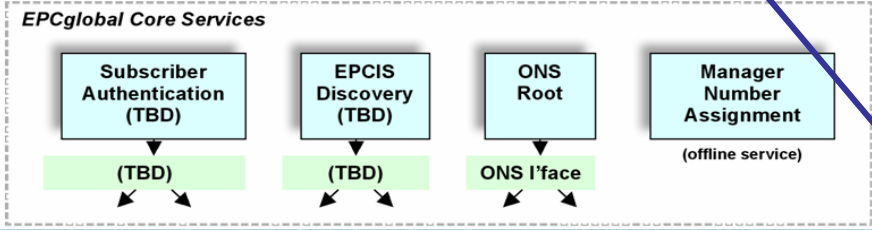

Figure 2-1 EPCIS and Other EPC Standards



(from EPCglobal)

◆ RFID

- ❖ Data confidentiality
- ❖ Tag Anonymity
- ❖ Data integrity
- ❖ 1-way/Mutual authentication
- ❖ Light-Weight (CRC and Hash)-based authentication protocol

◆ Ubiquitous Computing Environments

- ❖ User Privacy Protection
- ❖ Authentication
 - Users, Devices, Messages
- ❖ Authorization
 - Role-based Access Control
 - Context-based Access Control
- ❖ Availability
 - Prevention of Denial of Service Attacks
- ❖ Data Security
 - Confidentiality
 - Integrity
 - Cryptographic key management & distribution
- ❖ Light-Weight Cryptographic Protocols
 - Symmetric & Asymmetric Schemes
 - Hash Functions & Digital Signatures
- ❖ Secure EPC network architecture

