

Generic Structures: Exponential Material Delays

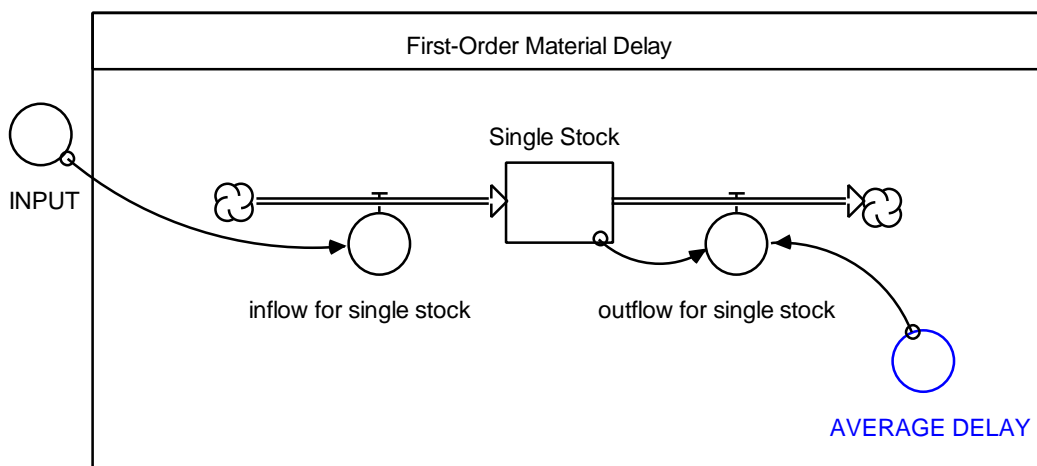

Prepared for the
MIT System Dynamics in Education Project
Under the Supervision of
Prof. Jay W. Forrester

by
Stephanie Albin

Copyright ©1998 by the Massachusetts Institute of Technology
Permission granted to distribute for non-commercial educational purposes

Table of Contents

1. ABSTRACT	5
2. INTRODUCTION	6
3. DELAYS	6
3.1 EXAMPLE 1: OIL DEGRADATION (FIRST-ORDER DELAY)	8
3.2 EXAMPLE 2: LOTTERY PAYOFF SPENDING (FIRST-ORDER DELAY)	9
3.3 EXAMPLE 3: TREE HARVESTING (THIRD-ORDER DELAY)	10
4. THE GENERIC STRUCTURE	11
4.1 MODEL DIAGRAM	11
4.2 MODEL EQUATIONS	12
5. BEHAVIORS PRODUCED BY THE GENERIC STRUCTURE	15
5.1 PULSE INPUT	15
5.2 STEP INPUT	18
6. USING MATERIAL DELAYS IN MODELING	20
7. EXERCISES	23
7.1 EXERCISE 1: MATERIAL VS. INFORMATION DELAYS	23
7.2 EXERCISE 2: MAIL DELIVERY SYSTEM	23
7.3 EXERCISE 3: GENERIC MATERIAL DELAY ANALYSIS	24
8. SOLUTIONS TO EXERCISES	25
8.1 SOLUTION TO EXERCISE 1: MATERIAL VS. INFORMATION DELAYS	25
8.2 SOLUTION TO EXERCISE 2: MAIL DELIVERY SYSTEM	25
8.3 SOLUTION TO EXERCISE 3: GENERIC MATERIAL DELAY ANALYSIS	28
9. APPENDIX	29

9.1 EQUATIONS FOR EXAMPLE 1: OIL DEGRADATION MODEL	29
9.2 EQUATIONS FOR EXAMPLE 2: LOTTERY PAYOFF SPENDING MODEL	31
9.3 EQUATIONS FOR EXAMPLE 3: TREE HARVESTING MODEL	31
9.4 EQUATIONS FOR SECTION 6: FACTORY-DISTRIBUTOR MODEL	33

1. ABSTRACT

This paper introduces the generic structure of a material delay. A material delay is a delay in a physical flow. In contrast, an information delay is a delay in perception.

All delays are characterized by two parameters: the order of the delay and the average length of the delay. This paper uses Oil Degradation and Lottery Payoff Spending models as examples of first-order delays. A Tree Harvesting model is used as an example of a third-order delay.

After presenting the generic model diagram and equations, this paper analyzes the behaviors produced by the generic structure with various inputs. The outflows to a first-, second-, third-, fourth-, and infinite-order delay with pulse and step inputs are examined.

After presenting a brief section containing hints to using material delays in modeling, this paper concludes with three exercises.

2. INTRODUCTION

Generic structures are relatively simple structures that recur in many diverse situations. In this paper, for example, spilled oil degradation, inheritance spending, and tree harvesting systems are shown to share the same basic structure. Transferability of structure between systems makes the study of generic structures a fundamental part of learning system dynamics.

Road Maps contains a series of papers which use generic structures to develop an understanding of the relationship between the structure and behavior of a system. Such an understanding should help one refine intuition about surrounding systems and improve one's ability to model system behaviors.

Knowledge about a generic structure in one system is transferable to understand the behavior of other systems with the same structure. Thus, generic structures assist one in understanding systems never studied before.

This paper introduces the generic structure of material delays. Many examples of systems containing the material delay generic structure will be used to illustrate both the transferability and functionality of the structure. Soon the reader will be able to recognize material delays in many new and different models.

3. DELAYS

In real life the flow of non-physical information and physical material from one place to another takes time. Delivery of a package takes days and full comprehension of a new idea can take years. Delays are an inherent part of all flows. Including a time delay in every flow when building a system dynamics model, however, is impractical. Often, a system delay is so short that its effect is negligible in comparison to longer or more significantly located delays. For example, the delay in loading a delivery van is insignificant to the delay in driving the van from its origin in New York to its destination in California. Through practice, a modeler will learn to recognize which delays are significant and which are not.

An delay is a stock-and-flow structure that accepts a given inflow and delivers a resulting outflow. A delay can be characterized as an exponential delay because, in the simplest form, the outflow equals the stock divided by the average delay, which characteristically produces exponential decay.¹ Note that the outflow from the delay structure is determined only by the stocks of the delay and by the average delay time. The inflow to the delay is independent of the delay structure. Essentially, a delay modifies the time relationship between the inflow and outflow delay structure.

Exponential delays in system dynamics are defined by two parameters: the order of the delay and the average length of the delay. The order of the delay is the number of stocks (or integrations) between the inflow and outflow of the delay structure. The average length of the delay is the average time between the initial input and the final output. The average length of the total delay is divided evenly among each stock in a higher-order delay.

Exponential delays can be divided into two categories: material and information. A material delay modifies a physical flow, while an information delay is a delay in perception. Under most conditions with identical inputs, the output of a material delay is identical to the output of an information delay. The stock-and-flow structures are, however, fundamentally different. This paper will cover only material delays. The reader should keep in mind that a material delay does not lose or create any units of the flow traveling through the delay structure. Each unit that flows into the delay must either be stored in a stock of the delay, or flow out of the delay.

Many software programs, such as STELLA, allow the modeler to define a converter as a delay using special functions without explicitly modeling the stock-and-flow structure. While such short-cuts are useful, the modeler must understand that all delays contain stocks as part of the delay structure. If the STELLA diagram contains a special function converter defined as a delay, then the diagram contains a stock within that

¹ For more information see: Stephanie Albin, 1996. *Generic Structures: First order negative feedback loops*. (D-4475-1), System Dynamics Group, Sloan School of Management, Massachusetts Institute of Technology, September 25, 22 pp.

converter. When simulating the model, the software treats the delay converter as containing a stock and carries out the appropriate integrations.

3.1 Example 1: Oil Degradation (first-order delay)²

Figure 1 depicts a model of a simple pollution degradation system. When oil is spilled and contaminates a shoreline, such as the Exxon Valdez spill that contaminated Prince William Sound, often the best course of action is to do nothing. Adding additional detergents or bacteria too speed up oil degradation may do more harm than good by further damaging the natural habitat. The oil will naturally disappear through a combination of biodegradation, evaporation, and dissipation due to weather patterns. The stock, “Oil Spilled on Shore,” represents the amount of oil spilled that reaches the shore. The oil accumulates at a rate equal to the “OIL SPILL.” Through various factors mentioned above, the oil will degrade naturally at a rate equal to the “Oil Spilled on Shore” divided by the “AVERAGE TIME TO DEGRADE OIL”. After a certain length of time (equal to the “AVERAGE TIME TO DEGRADE OIL”), the oil levels on the shore should be at minute, non-toxic levels.

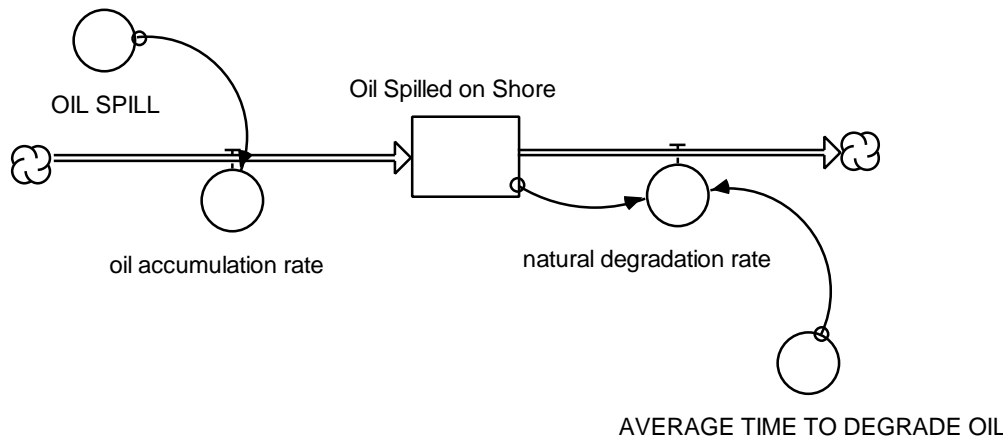

Figure 1: Oil Degradation Model

The degradation of oil, a time-delayed process, is the environment’s response to an oil spill. The degradation of spilled oil is a material delay because it deals with the flow of a material substance (the oil) into and out of a stock (the oil spilled on the shore). Figure

² For equations of all example models, please see appendix.

1 contains only one stock, making the Oil Spill Degradation model a first-order material delay.

3.2 Example 2: Lottery Payoff Spending (first-order delay)

Figure 2 shows another example of a first-order material delay. In the Lottery Payoff Spending model, a first-order material delay is used to represent the delay in spending a large sum of money such as a lottery winning. Often a person who has won a large sum of money will spend large amounts of money the first few weeks and substantially less as time goes on and the novelty of being a millionaire has worn off. A first-order delay is a good approximation of such behavior. The stock “Money in Bank Account” represents the delay between the time the money is won and the time the money is spent. The “money accumulation rate” equals the weekly “LOTTERY WINNINGS.” The winnings are spent each week at a “money spending rate” equal to the value of “Bank Account” divided by the “AVERAGE TIME TO SPEND WINNINGS.”

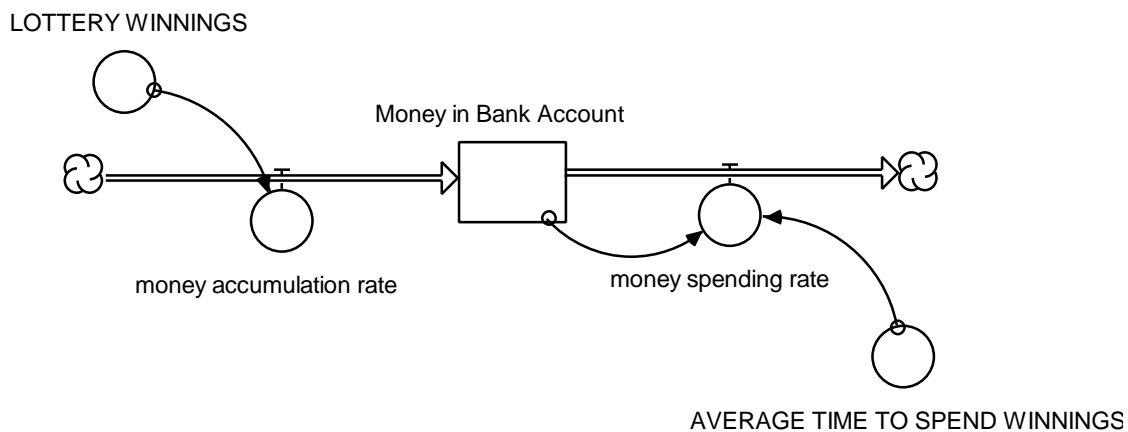

Figure 2: Lottery Payoff Spending Model

Again, the Lottery Payoff Spending model deals with the material flow of money from being won to being spent. The model is first-order because it only contains one stock; the inflow is only being delayed once, by a single stock.

3.3 Example 3: Tree Harvesting (third-order delay)

The Tree Harvesting model in Figure 3 captures the dynamics of a tree farm where a delay exists between the time a tree is planted and the time the tree is harvested. The length of the overall delay is the “AVERAGE MATURATION TIME.” With three stocks present in the delay, the tree harvesting model contains a third-order delay. In higher-order delays (structures with two or more delay stocks) the convention is to spread the delay evenly over each stock. In the rate equations which flow out of a stock, the “AVERAGE MATURATION TIME” constant is divided by three. The “sapling maturation rate” equals “Saplings” divided by one-third of the “AVERAGE MATURATION TIME”. The “medium tree maturation rate” equals “Medium Trees” divided by one-third of the “AVERAGE MATURATION TIME.” The “harvest rate” equals “Harvestable Trees” divided by one-third of the “AVERAGE MATURATION TIME.”

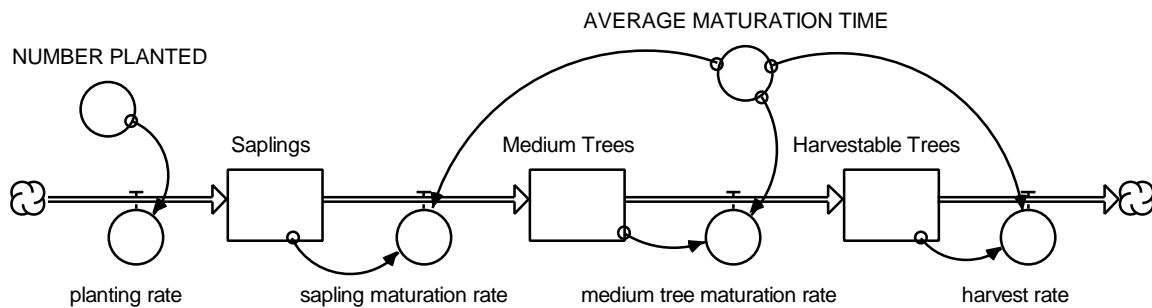

Figure 3: Tree Harvesting Model

“NUMBER PLANTED” is simply the number of trees planted each year. The “planting rate” is equal to the “NUMBER PLANTED.”

Even though Figure 3 contains three stocks, whereas Figures 1 and 2 contain only one stock, similarities in structure exist. Each outflow equation is simply the stock divided by the time constant scaled by the number of stocks in the delay. The similarities exist because all three example models contain the same material delay generic structure.

4. THE GENERIC STRUCTURE

This paper will now examine the generic structure of material delays used in all three examples. First, two models of the generic structure, first- and third-order, will be presented. Then, model equations for both cases will be examined.

4.1 Model Diagram

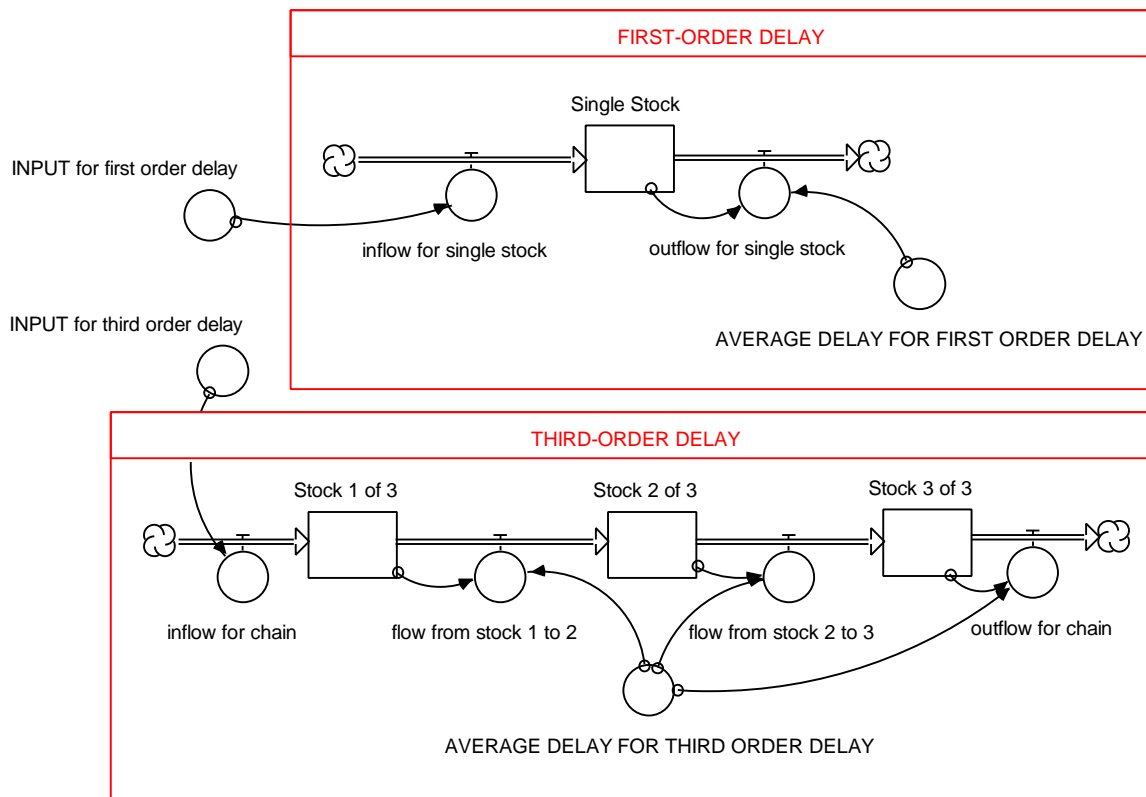

Figure 4: Generic Structures of a First- and Third-order Delay

Figure 4 contains the generic structures of first- and third-order delays. Note that to create a second-, fourth-, or higher-order delay, one must either lengthen or shorten the chain of stocks in the third-order delay model and put in the appropriate links from the average delay converter to the flows. Given any "INPUT," the models in Figure 4 will create an appropriate delay of length equal to the "AVERAGE DELAY" between the inflow and final outflow of the single stock or stock chain. The behavior of the outflow

will differ depending on the order of delay. The different outflow curves will be examined in a later section of this paper.

4.2 Model Equations

FIRST-ORDER DELAY

INPUT_for_first_order_delay = *a constant*

DOCUMENT: “INPUT for first order delay” is the input to the delay. It can be a constant, a pulse, a sine wave, or any other function.

UNIT: Unit/time

inflow_for_single_stock = INPUT_for_first_order_delay

DOCUMENT: The inflow for a single stock is the input to the system. It is the inflow that undergoes the first-order time delay.

UNIT: Unit/time

$$\text{Single_Stock}(t) = \text{Single_Stock}(t - dt) + (\text{inflow_for_single_stock} - \text{outflow_for_single_stock}) * dt$$

DOCUMENT: This is the single stock in a first-order delay. It corresponds to the stocks of “Oil Spilled on Shore” and “Money in Bank Account” in examples 1 and 2. This stock holds the amount of material stored in the delay, which is in transit between the inflow and outflow for the stock.

UNIT: Unit

outflow_for_single_stock = Single_Stock /

AVERAGE_DELAY_FOR_FIRST_ORDER_DELAY

DOCUMENT: The outflow for a single stock is the delayed response of the input inflow for a single stock.

UNIT: Unit/time

$AVERAGE_DELAY_FOR_FIRST_ORDER_DELAY = a\ constant$

DOCUMENT: This is the average time it takes each unit to go from flowing into the stock to flowing out of the stock.

UNIT: Time

THIRD-ORDER DELAY³

$INPUT_for_third_order_delay = a\ constant$

DOCUMENT: “INPUT for third order delay” is the input to the delay. It can be a constant, a pulse, a sine wave, or any other function.

UNIT: Unit/time

$inflow_for_chain = INPUT_for_third_order_delay$

DOCUMENT: The inflow for chain represents the inflow to the third-order delay.

UNIT: Unit/time

$Stock_1_of_3(t) = Stock_1_of_3(t - dt) + (inflow_for_chain - flow_from_stock_1_to_2) * dt$

DOCUMENT: This is the first stock in a chain of three stocks that constitute the third-order delay. This stock is delaying the “inflow for chain,” and corresponds to “Saplings” in example 3.

UNIT: Unit

$flow_from_stock_1_to_2 =$

$Stock_1_of_3 / (AVERAGE_DELAY_FOR_THIRD_ORDER_DELAY / 3)$

DOCUMENT: The “flow from stock 1 to 2” is the outflow of the first stock of the delay chain and is the inflow for the remaining chain.

UNIT: Unit/time

³ Mathematically, any delay of order “n” with an average delay equal to “D” is equivalent to “n” cascaded first-order delays each having an average delay equal to “D/n.”

$$\text{Stock_2_of_3}(t) = \text{Stock_2_of_3}(t - dt) + (\text{flow_from_stock_1_to_2} - \text{flow_from_stock_2_to_3}) * dt$$

DOCUMENT: “Stock 2 of 3” stores part of the input material that is being delayed. This stock is further delaying the already-delayed material transferred by “flow from stock 1 to 2.” “Stock 2 of 3” corresponds to “Medium Trees” in example 3.

UNIT: Unit

$$\text{flow_from_stock_2_to_3} = \text{Stock_2_of_3}/(\text{AVERAGE_DELAY_FOR_THIRD_ORDER_DELAY}/3)$$

DOCUMENT: The “flow from stock 2 to 3” is the outflow of the second stock of the delay chain and is the inflow for the remaining chain.

UNIT: Unit/time

$$\text{Stock_3_of_3}(t) = \text{Stock_3_of_3}(t - dt) + (\text{flow_from_stock_2_to_3} - \text{outflow_for_chain}) * dt$$

DOCUMENT: “Stock 3 of 3” accumulates the already-delayed outflow from stock 2 and delays it again. “Stock 3 of 3” corresponds to the “Harvestable Trees” in example 3.

UNIT: Unit

$$\text{outflow_for_chain} = \text{Stock_3_of_3}/(\text{AVERAGE_DELAY_FOR_THIRD_ORDER_DELAY}/3)$$

DOCUMENT: The outflow for the entire chain is a delayed appearance of the “INPUT for third order delay” material inflow for the chain.

UNIT: Unit/time

$$\text{AVERAGE_DELAY_FOR_THIRD_ORDER_DELAY} = a \text{ constant}$$

DOCUMENT: This is the average time it takes for each unit from flowing into to flowing out of the entire chain. It is important to note that the total “AVERAGE DELAY FOR

THIRD ORDER DELAY” is spread out over all three stocks of the delay. Division by 3 in each of the outflow equations is necessary to accurately capture the average delay.

UNIT: time

5. BEHAVIORS PRODUCED BY THE GENERIC STRUCTURE

The transient response of a material delay changes as the number of stocks in the delay is increased. This section will examine the transient responses of first-, second-, third-, and fourth-order delays to various inputs.

5.1 Pulse Input

The STELLA software has a built-in function called “PULSE.” This paper will use the PULSE function as an input to material delays of various orders, and will graph and analyze the resulting outputs.

The PULSE function generates an input of a specified size at a specified time for a length of time equal to the simulation time step (DT) of the model. The PULSE function in STELLA takes the form:

PULSE(<volume>[, <first pulse>, <interval>])

The height of the pulse equals the **volume** divided by DT. If, for example, a volume of 10 is pulsed with a simulation DT set to 0.25 time-units, the actual number of units pulsed is $10/0.25$, which equals 40 units. The pulse of 40 units lasts 0.25 time-units of the model. If the PULSE(10, 0, 9999) with a DT of 0.25 were the inflow to a stock (initial value equal to zero) then the value of the stock after the first time step would be 10 units. The rate of inflow would equal 40 units, but only for 0.25 time-units, resulting in a stock value of only $40 * 0.25$, or 10 units. **First pulse** specifies the time at which the first pulse occurs. **Interval** is the period of time between subsequent pulses. If only one initial pulse is desired, the interval value should be set to a number that is greater than the maximum length of simulation. 9999 years is greater than any of the simulation lengths that will be used in this paper.

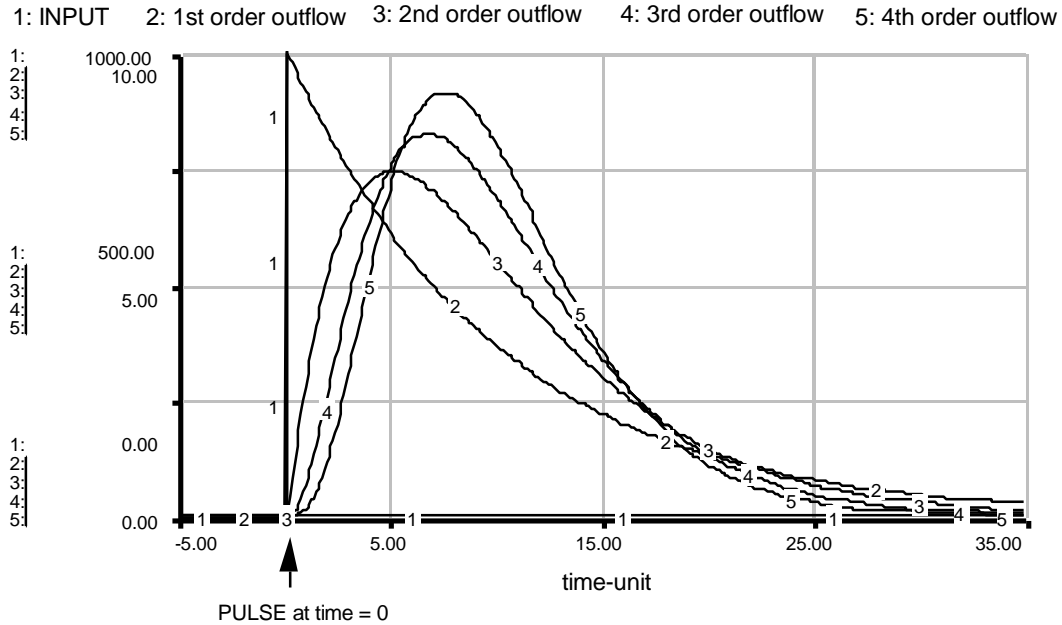

Figure 5: Outflows for First-, Second-, Third- and Fourth-Order Delays⁴

Figure 5 contains a graph of the outflows of first-, second-, third-, and fourth-order delays.⁵ The initial inflow for each delay is a pulse of 1000 units of material over 0.1 time-units.⁵ With a DT of 0.1, the volume of the pulse is thus 100 units. The exact equation of the “INPUT” for the STELLA models is: $\text{INPUT} = \text{PULSE}(100, 0, 9999)$, which creates a pulse of 1000 units at time zero. The initial level of each stock was set to zero and the average delay for each material delay was set to 10 time-units. Note that the delay is divided evenly among each of the flows in a higher-order delay.

The pulse input is simply depositing 100 units of material into the delay chain at time zero. Imagine the inflow of the delay as 100 items inserted into a transportation system at one moment, and the outflow of the delay as the rate of arrival of the items at their destinations.

⁴ The time scale of the graph in Figure 7 begins at -5 time-units so that the PULSE input at time 0 can be easily seen.

⁵ The structures used for the first- and third-order delays are identical to those presented in Figure 4. The structures for the second- and fourth-order delays are similar, varying only by the number of stocks present.

Curve 2 in Figure 5 shows the outflow of a first-order exponential delay. From the graph one can see that the maximum rate of output occurs immediately after the pulse input, and the outflow decreases exponentially thereafter.

For the second-order delay outflow, curve 3, the initial outflow is zero because the entire input is momentarily stored in the first stock of the two-stock delay chain. The level of the second stock is thus zero immediately after the pulse, so there can be no outflow from it. Note also that the output curve has its maximum slope at the origin. The maximum slope occurs at the origin because the second stock of the two-stock delay chain is delaying the outflow from the first stock. The outflow from the first stock is an exponential decay, similar in shape to curve 2, and has the maximum value immediately after time zero.

Curve 4, the outflow of a third-order material delay, has an initial output of zero and an initial slope also of zero. The outflow curve begins to rise slowly, reaches a maximum slope and a peak value, and then falls off. The third-order delay outflow peaks higher and later in time than the second-order delay outflow. The third stock of the three-stock delay chain acts like a first-order delay with an input similar in shape to curve 3. The initial slope equals zero because the initial input to the third-stock of the delay chain is zero.

The fourth-order delay curve is very much like the third-order delay curve. The fourth-order outflow curve also begins with a value of zero and a slope equal to zero, characteristics that are shared by all higher-order curves. Again, the fourth-order outflow peaks higher in magnitude but later in time than the third-order outflow curve. From Figure 5, one can observe that as the order of the delay increases, the outflow peaks at a higher value and at a time that is closer to the average delay time. Continuing along similar lines of reasoning, the ultimate end member of the delay family is the hypothetical infinite-order delay.⁶ An infinite-order delay, also known as a discrete or pipeline delay, is shown in Figure 6.

⁶ Jay W. Forrester, 1961. *Industrial Dynamics* (p. 86-92), Portland, OR: Productivity Press, 464 pp.

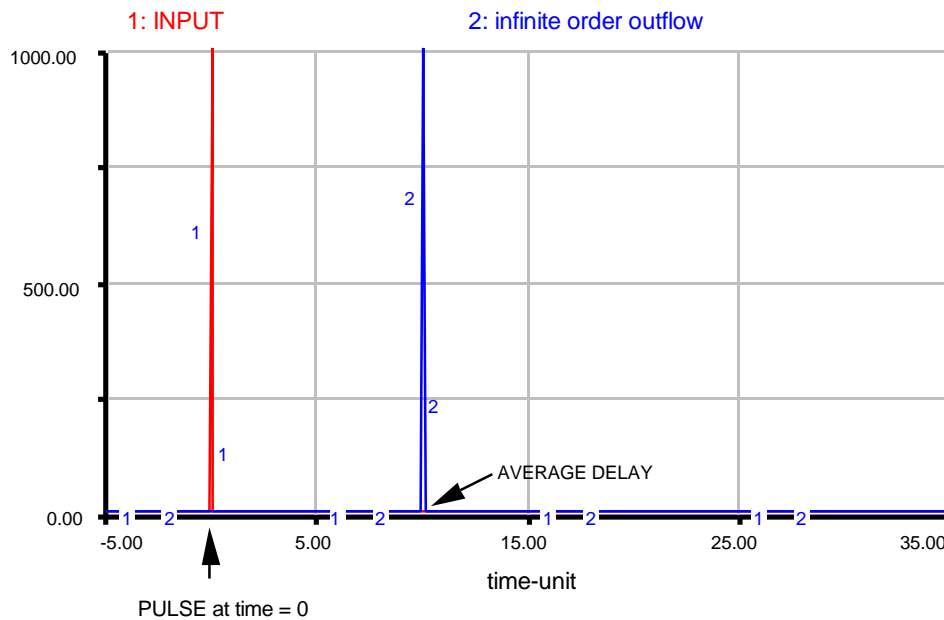

Figure 6: Outflow for Infinite-Order Delay

The outflow of the infinite-order delay is zero until, at a time equal to the average delay, the entire pulse input flows out of the delay chain. To model an infinite-order delay in STELLA, one can use the built-in DELAY function. The DELAY function takes the form:

DELAY(<input>, <delay duration> [,<initial>]).

The delay outflow in Figure 6 was created with the identical pulse “INPUT” used in Figure 5, a **delay duration** or average delay equal to 10, and an **initial** delay value of zero for the stocks in the infinite-chain. In STELLA, the equation for the converter “infinite order outflow” equals DELAY(INPUT, 10, 0). As one can see, the amount of material pulsed into the delay is conserved as that same volume is pulsed out at a time equal to the average delay.

The model of an infinite-order delay is simply the “INPUT” converter connected by an information link to a converter whose equation is the DELAY function, as described above. Even though the model diagram does not contain any stocks, the stocks of the delay are internal to the second converter. STELLA simulates the two-converter model as if it were a model containing an infinitely long chain of stocks.

5.2 Step Input

The STELLA software also has a built-in function called “STEP.” This section will use the STEP function as an input to material delays of various orders, and the output will be graphed and analyzed.

The STEP function generates a step input of a specified size or **height** at a specified **time**. The input to the STEP function is in the form

$$\text{STEP}(\langle \text{height} \rangle, \langle \text{time} \rangle).$$

For the graphs in Figures 7 and 8, a STEP of 100 units of material flows into the delay at time 0. The INPUT equals $\text{STEP}(100, 0)$, and each delay-chain has an average delay of 10 time-units and the stocks had an initial value of zero. Figure 7 graphs the outflows resulting from the STEP input to a first-, second-, third-, and fourth-order delay.

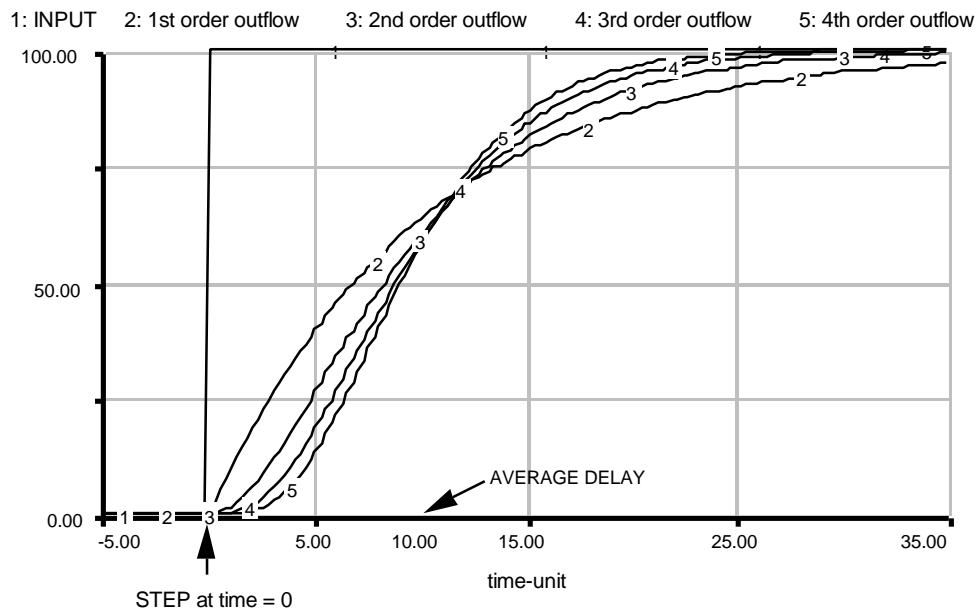

Figure 7: Outflows for First-, Second-, Third- and Fourth-Order Delays

Curve 2 represents the output of a first-order material exponential delay in response to a STEP input at time zero equal to 100 units. The first-order outflow is an exponential rise in outflow of the units of material. The area between the “INPUT” curve 1 and the first-order output curve 2 is a measure of the number of units that accumulate in

the delay stock. For the first-order delay graphed in Figure 7, the “INPUT” is constant and equal to 100 units, resulting in a total output (the outflow summed over time) which is less than the total input (the “INPUT” summed over time) by the number of units stored in the delay stock. It is also important to note that the first-order outflow curve has its maximum slope at the time of the STEP.

Curve 3, the outflow of a second-order delay in response to a STEP input, curve 4, the outflow of a third-order delay, and curve 5, the outflow of a fourth-order delay, all have the same basic S-shape. The outflow curves 3, 4, and 5 initially have a slope of zero because the outflow from the first stock in the chain equals zero. The slope then increases at first and then decreases as the outflow asymptotically approaches the level of input. Mathematically, the outflow of an exponential material delay of any order (with the exception of an infinite-order delay) will never “reach” the value of the inflow, but the difference is so small in magnitude that the effect is usually insignificant. Also, as the order of the delay (greater than second-order) increases, the point of time at which the slope changes from increasing to decreasing approaches the average delay time.

The outflow of an infinite-order delay in response to the identical STEP input is shown in Figure 8. The input step rises suddenly from zero to its final value, and the infinite-order delay steps from zero to final value at 10 time-units later. The outflow mirrors the step input after a time shift equal to the average delay time.

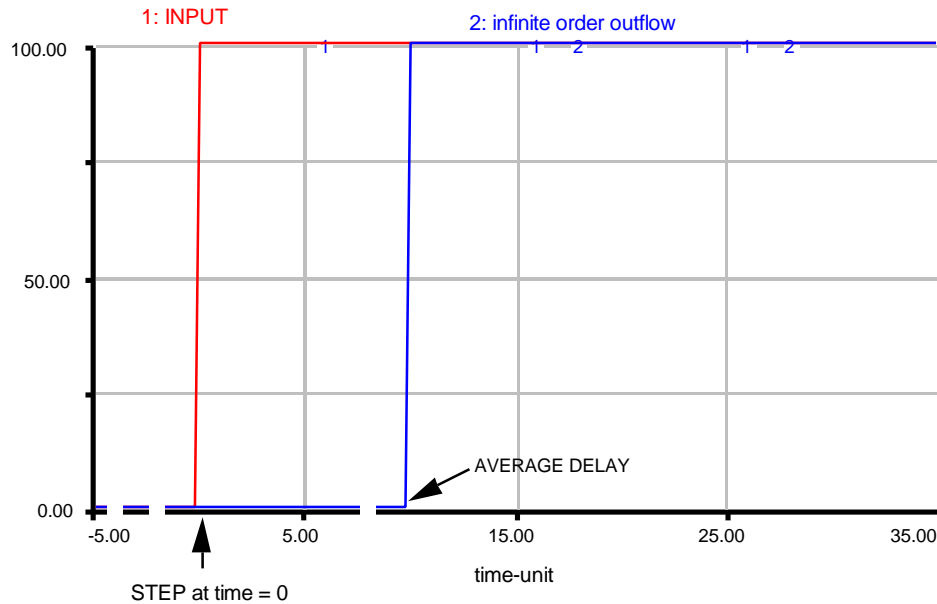

Figure 8: Outflow for Infinite-Order Delay

6. USING MATERIAL DELAYS IN MODELING

Material delays exist in many diverse systems such as a mail delivery system, breakdown of a radioactive isotope, or construction of buildings. In order to best approximate the order of a delay in a system dynamics model, a modeler must consider the system's real-life behavior. The shape of the system's real-life delayed outflow should be approximated by the material delay's outflow. Consider the delay in shipping goods from a factory to distributors.⁷ Think of a large shipment of simultaneous orders (a "pulse") that is being transported from a factory to its distributors, and try to characterize the delay in the rate of arrival to the distributor.

Figures 5 and 6 show the outflows of a pulse input to first-, second-, third-, fourth-, and infinite-order delays. A modeler can consider the curves in Figures 5 and 6 to be possible rates of arrival of a good, with the "INPUT" equaling the large shipment of simultaneous orders. The outflow curve of a first-order material delay in response to a pulse input is an exponentially decreasing curve with the maximum rate of arrival of the

⁷ Jay W. Forrester, 1961. *Industrial Dynamics* (p. 89-92), Portland, OR: Productivity Press, 464 pp.

good at the instant the shipments are made. Because the maximum rate of arrival of a good does not occur at the moment the goods have been shipped, the first-order delay should be eliminated as a possible structure in the factory-distributor model.

The second-order delay outflow curve in Figure 5 has a zero rate of outflow at time zero. Similarly, our example system has a zero rate of arrival at the time the shipments are made. The second-order delay outflow curve, however, has its maximum slope at the origin, which is unrealistic in the factory-distributor system. One does not expect the rate of arrivals to rise rapidly at the moment the shipments leave the factory.

Now consider the infinite-order delay outflow curve in Figure 6. Because the goods being shipped do not all arrive at the distributors at the same instant, the infinite-order delay possibility can be eliminated.

The delay outflow curves in Figure 5 for the third- and fourth-order delay both contain the necessary requirements of an arrival rate of zero at the time the shipments are made, and a slowly increasing arrival rate of goods. Choosing between third- and higher-order delays means studying the actual rate of arrival carefully and picking the order of delay that most closely matches the behavior of the system. In most cases, however, the extra precision gained from an intensive study of the real system will not have an appreciable effect on model behavior and the cost of such a study will not be worthwhile.

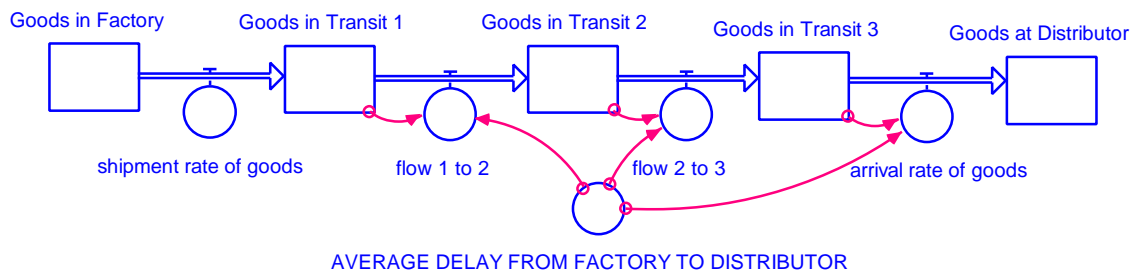

Figure 9: Factory - Distributor Model⁸

Figure 9 contains a model of a factory-distributor system. The three stocks of the third-order delay are “Goods in Transit 1,” “Goods in Transit 2,” and “Goods in Transit

⁸ Equations for the Factory-Distributor Model are located in Section 9.4 of the Appendix.

3.” The actual names of the three delay stocks are unimportant, because the modeler is only interested in the “arrival rate of goods.” If the goods were being shipped from a factory in Mexico to a distributor in Canada through the United States, for example, the names of the delay stocks could be “Goods in California,” “Goods in Oregon,” and “Goods in Washington.” The “arrival rate of goods” will be the outflow of a third-order delay with an input of the “shipment rate of goods,” regardless of the names of the internal delay stocks and flows.

Some system dynamics modeling software programs have built-in functions for material delays where the modeler can specify the average delay and the order of the delay without needing to explicitly model the stock-and-flow delay structure. Consult the technical manual of the particular modeling software used for more information.

7. EXERCISES

The following exercises provide the reader with a chance to apply and practice using the generic structure of a material delay. Solutions are located in section 8 of this paper.

7.1 Exercise 1: Material vs. Information Delays

Section 3.1 of this paper briefly explained the difference between material and information delays. Remember, a material delay modifies a physical flow. Information delays are delays in perception. Below is a list of systems in which some flow is being delayed. Which are material delays? Which are information delays?

1. Delay in production of applesauce from harvested apples
2. Delay in firing team manager when sports team loses games
3. Delay in arrival of mail
4. Delay in the increased number of carpools due to an increase in price of gas
5. Delay in growth of ripe tomatoes from a tomato plant seed
6. Delay in making a decision after collecting necessary data

7.2 Exercise 2: Mail Delivery System

Rachel and Ross are getting married. They want to get married as soon as possible, but they are afraid that if they pick a day too soon, their invitations will not be delivered on time. To help them pick a date, they have asked you to build a system dynamics model of the mail system.

Assume it takes an average of 3 days for any invitation to get sorted at the post-office of origin, transported, and sorted again at the destination post-office. Rachel and Ross are sending out 200 invitations and would be satisfied if 175 of them were delivered the day before the wedding. Try carrying out the same type of analysis done in section 6 of this paper to help build the delay structure of the mail delivery model. Use a PULSE function input on day zero as the depositing of 200 invitations into the mail system. What is the earliest day when Rachel and Ross can get married if the invitations are sent out on February 8th?

7.3 Exercise 3: Generic Material Delay Analysis

Consider the following two generic delay structures.

Delay Structure 1: A third-order delay with an average delay length of 20 time-units.

Delay Structure 2: Three cascaded first-order delays forming a chain. The first delay has an average delay of 1 time-unit, the second delay has an average delay of 1 time-unit, and the third-delay has an average delay of 18 time-units. Note these three average delays add up to 20 time-units, the average delay length of Delay Structure 1.

Figure 10 contains a picture of the two structures, but the model diagram is not necessary to solve this exercise.

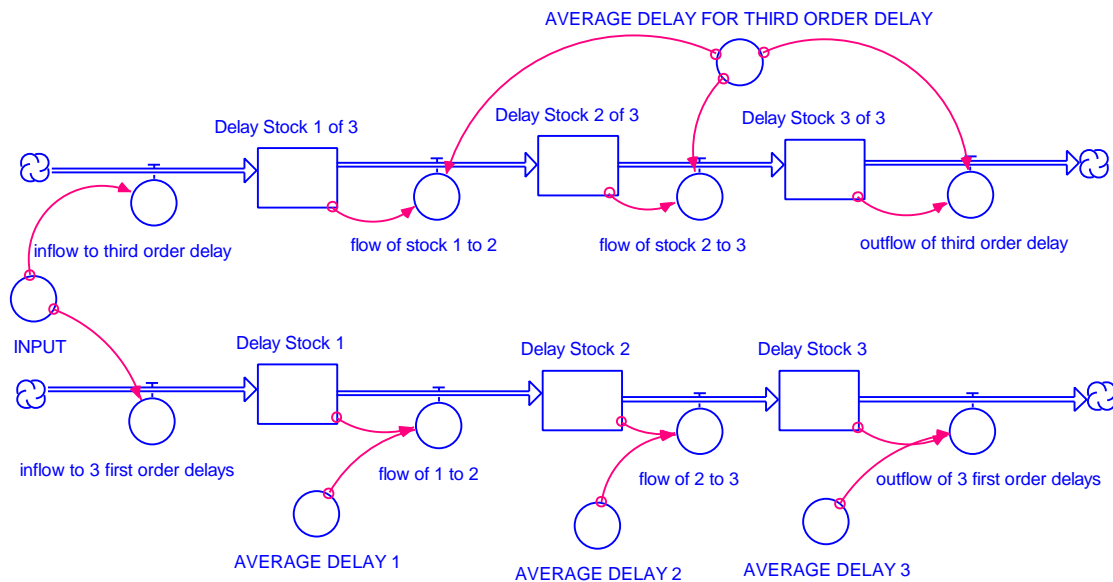

Figure 10: Stock-and-flow Diagram of Delay Structures 1 and 2

Answer the following questions assuming an initial INPUT pulse of 100 units of material.

1. Will the outflow curves for the third-order delay structure be identical to the outflow of the chain of three first-order delays?
2. Which outflow curve will have a higher peak? Which outflow curve will peak at a time closer to 20 time-units? Why?

8. SOLUTIONS TO EXERCISES

8.1 Solution to Exercise 1: Material vs. Information Delays

1. Material (delay in the physical flow of apples from tree, to factory, through mashing machines)
2. Information (delay in the realization that the team is on a losing streak due to bad management)
3. Material (delay in the physical flow of letters due to sorting and transportation)
4. Information (delay in realization that the increase in gas prices is permanent and to join a carpool is more economical)
5. Material (delay in maturation of a seed to a fruit-bearing plant)
6. Information (delay in analyzing data to making the final decision based on the data)

8.2 Solution to Exercise 2: Mail Delivery System

Following the same reasoning presented in Section 6 as to why the “arrival rate of goods” is the outflow to a third-order delay, the “mail delivery rate” is also a third-order material delay outflow. The model diagram in Figure 11 contains a third-order delay with stocks of “Mail Sorted at Post Office 1,” “Mail in Transit,” and “Mail Sorted at Post Office 2.” Note that the names of the three delay stocks are unimportant and the exercise focuses on the number of delivered invitations as the important variable of the system. The equations at the end of this subsection, in particular the equation of “mail deposit rate,” were selected with a DT of 0.25. For the Mail Delivery System, the “mail deposit rate” equals 800 invitations/day at day zero, but only lasts one-quarter day. The “mail deposit rate” then dumps in exactly 200 invitations into the “Mail Sorted at Post Office 1” stock.

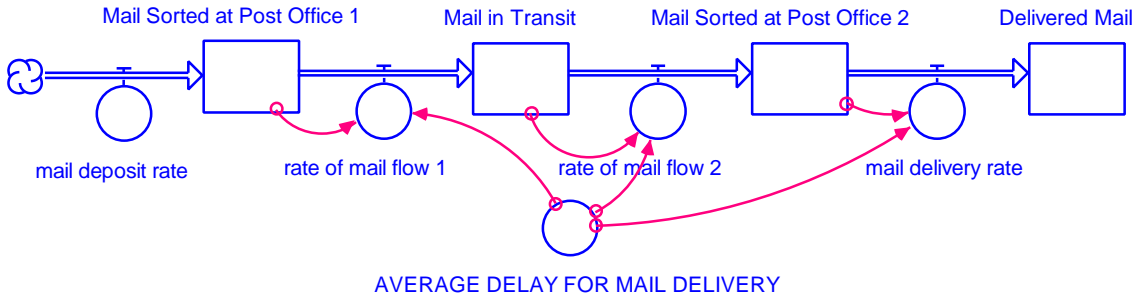

Figure 11: Mail Deliver System

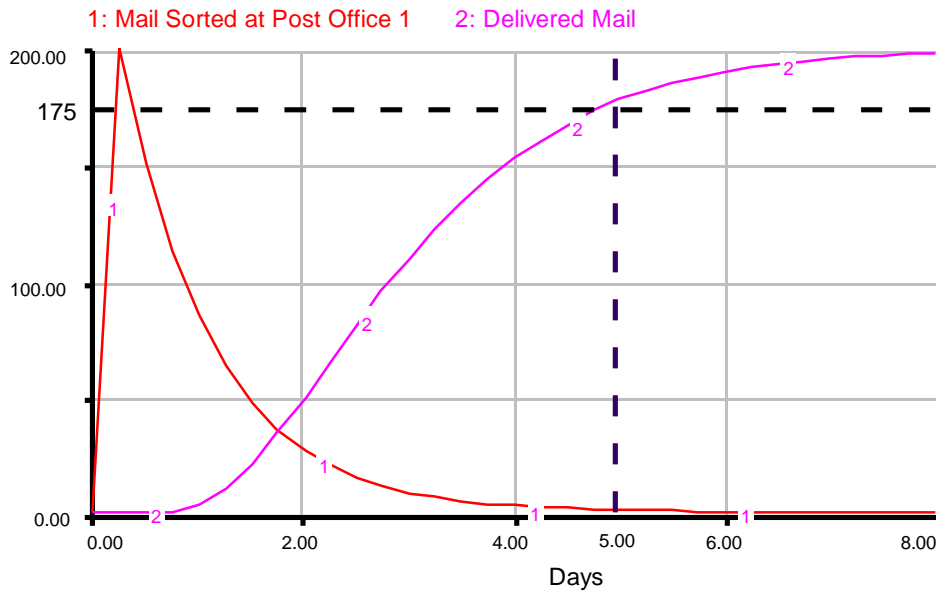

Figure 12:

From the graph in Figure 12, a simulation run of the model in Figure 11, it is obvious that 175 invitations will be delivered by the fifth day after mailing the invitations. Rachel and Ross should have their wedding one day later—on February 14th, Valentine’s Day.

Equations:

$$\text{mail_deposit_rate} = \text{PULSE}(200,0,9999)$$

DOCUMENT: The pulse function is used to represent the deposit of 200 wedding invitations into the mailbox. DT is set to 0.25, so the number of invitations pulsed into the first stock of the delay equals 200.

UNIT: Invitation

$$\text{Mail_Sorted_at_Post_Office_1}(t) = \text{Mail_Sorted_at_Post_Office_1}(t - dt) + (\text{mail_deposit_rate} - \text{rate_of_mail_flow_1}) * dt$$

$$\text{INIT Mail_Sorted_at_Post_Office_1} = 0$$

DOCUMENT: The first stock of the delay .

UNIT: Invitation

$$\text{rate_of_mail_flow_1} =$$

$$\text{Mail_Sorted_at_Post_Office_1}/(\text{AVERAGE_DELAY_FOR_MAIL_DELIVERY}/3)$$

DOCUMENT: The flow of invitations from the post office of origin to a mail truck en route.

UNIT: Invitation/day

$$\text{Mail_in_Transit}(t) = \text{Mail_in_Transit}(t - dt) + (\text{rate_of_mail_flow_1} - \text{rate_of_mail_flow_2}) * dt$$

$$\text{INIT Mail_in_Transit} = 0$$

DOCUMENT: The second stock of the delay.

UNIT: Invitation

$$\text{rate_of_mail_flow_2} =$$

$$\text{Mail_in_Transit}/(\text{AVERAGE_DELAY_FOR_MAIL_DELIVERY}/3)$$

DOCUMENT: The flow of invitations from the mail in trucks to being sorted mail at the post-office.

UNIT: Invitation/day

$$\text{Mail_Sorted_at_Post_Office_2}(t) = \text{Mail_Sorted_at_Post_Office_2}(t - dt) + (\text{rate_of_mail_flow_2} - \text{mail_delivery_rate}) * dt$$

$$\text{INIT Mail_Sorted_at_Post_Office_2} = 0$$

DOCUMENT: The third stock of the delay.

UNIT: Invitation/day

mail_delivery_rate =

$$\text{Mail_Sorted_at_Post_Office_2}/(\text{AVERAGE_DELAY_FOR_MAIL_DELIVERY}/3)$$

DOCUMENT: The rate of arrival of invitations after a third-order delay.

UNIT: Invitation/day

Delivered_Mail(t) = Delivered_Mail(t - dt) + (mail_delivery_rate) * dt

INIT Delivered_Mail = 0

DOCUMENT: The stock of delivered mail is not part of the third-order delay and represents the mail that has been successfully delivered.

UNIT: Invitation

AVERAGE_DELAY_FOR_MAIL_DELIVERY = 3

DOCUMENT: The average time it takes one invitation of Rachel and Ross to reach its destination. The average delay time is divided evenly over the three stocks of the delay.

UNIT: Day

8.3 Solution to Exercise 3: Generic Material Delay Analysis

1. The two outflows are not identical.
2. The outflow of the three first-order delays will peak higher than the outflow of the third-order delay. The higher peak is also further away from 20 time-units. An actual simulation of the two structures, shown in Figure 13, verifies that the outflow from the three first order delays peaks higher and earlier than the outflow of the third-order delay.

The behavior of the two outflow curves can be explained by considering the time one is dividing by in each internal flow equation. For the third-order delay, each stock is being divided by one-third the total average delay (20 time-units / 3). Each third-order delay stock is thus being divided by 6.67 time-units.

For the outflow of the third-order delay, the material is being delayed the same amount of time, 6.67 time-units, in each stock. For the outflow of the three first-order delays, the material is only being delayed a short time, one time-unit, in each of the first two stocks in the chain. The outflow rate for the three first-order delays will thus peak earlier because the material is being pumped through the first two stocks of the chain rather quickly. More material will reach the last stock of the three first-order delays chain than the last stock of the third-order delay, so the peak occurs earlier in time.

The easiest way to think about exercise 3 is to realize that the chain of three first-order delays is behaving almost like a single first-order delay of 20 time-units. The previous statement is verified by examining the graph in Figure 13. Notice that the “outflow of 3 first order delays” curve looks very much like the exponential decay outflow curve of a single first-order delay examined in Figure 5.

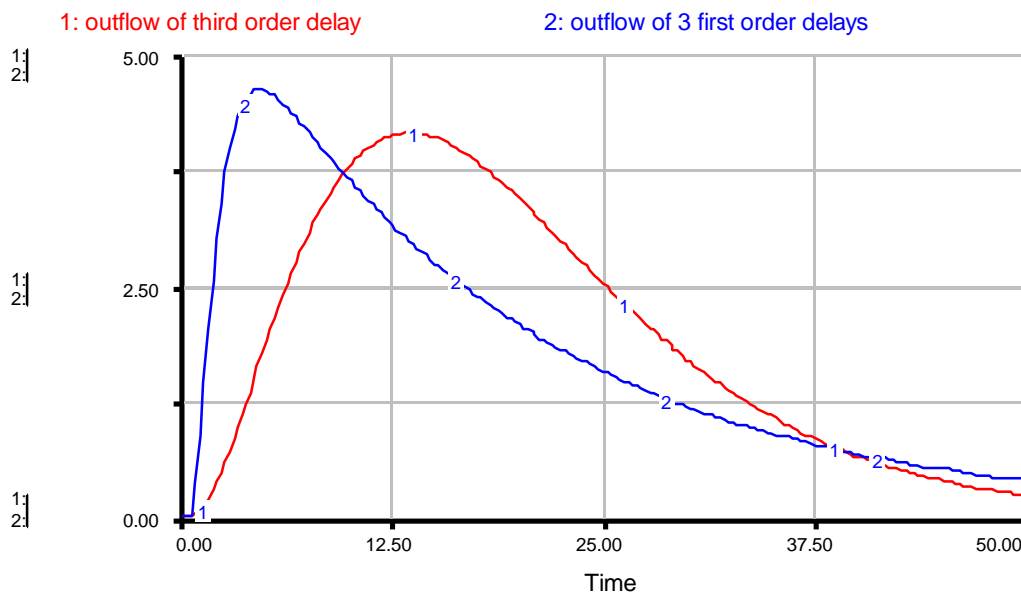

Figure 13: Outflow of the two structures in exercise 3

9. APPENDIX

9.1 Equations for Example 1: Oil Degradation Model

Oil_Spilled_on_Shore(t) = Oil_Spilled_on_Shore(t - dt) + (oil_accumulation_rate - natural_degradation_rate) * dt

INIT Oil_Spilled_on_Shore = 0

DOCUMENT: The amount of oil contaminating the shore.

UNIT: Gallon

INFLOWS:

oil_accumulation_rate = OIL_SPILL

DOCUMENT: Oil accumulates on the shore from oil spills.

UNIT: Gallon/year

OUTFLOWS:

natural_degradation_rate =

Oil_Spilled_on_Shore/AVERAGE_TIME_TO_DEGRADE_OIL

DOCUMENT: The rate at which oil degrades.

UNIT: Gallon/year

AVERAGE_TIME_TO_DEGRADE_OIL = 6

DOCUMENT: The average time for oil spilled on the shore to be naturally degraded.

UNIT: year

OIL_SPILL = PULSE(5000000, 1, 9999)

DOCUMENT: The amount of oil spilled that reaches the shore.

UNIT: Gallon

9.2 Equations for Example 2: Lottery Payoff Spending Model

Money_in_Bank_Account(t) = Money_in_Bank_Account(t - dt) +
(money_accumulation_rate - money_spending_rate) * dt

INIT Money_in_Bank_Account = 0

DOCUMENT: The amount of money in a bank account.

UNIT: Dollar

INFLOWS:

money_accumulation_rate = LOTTERY_WINNINGS

DOCUMENT: The accumulation of money from the lottery winnings into a bank account.

UNIT: Dollar/week

OUTFLOWS:

money_spending_rate =

Money_in_Bank_Account/AVERAGE_TIME_TO_SPEND_WINNINGS

DOCUMENT: The rate at which each weeks winnings are spent.

UNIT: Dollar/week

AVERAGE_TIME_TO_SPEND_WINNINGS = 9

DOCUMENT: The average length of time it takes the winner to spend his winnings is 2 months or 9 weeks.

UNIT: Week

LOTTERY_WINNINGS = PULSE(100000,0,9999)

DOCUMENT: The lottery payoff is a \$100,000 lump sum.

UNIT: Dollar/week

9.3 Equations for Example 3: Tree Harvesting Model

NUMBER_PLANTED = PULSE(250, 0, 9999)

DOCUMENT: The number of trees planted in the initial base year. 250 trees are planted the first year.

UNIT: Tree/year

planting_rate = NUMBER_PLANTED

DOCUMENT: The number of trees planted each year. In this model, 250 trees are planted the first year and no trees are planted in subsequent years.

UNIT: Tree/year

Saplings(t) = Saplings(t - dt) + (planting_rate - sapling_maturation_rate) * dt

INIT Saplings = 0

DOCUMENT: The number of saplings (baby trees) in a tree nursery.

UNIT: Tree

sapling_maturation_rate = Saplings/(AVERAGE_MATURATION_TIME/3)

DOCUMENT: The rate at which saplings mature into medium sized trees. Note that the average maturation time from a sapling to a harvestable tree must be split up over 3 stocks, thus the division by 3 in the equation.

UNIT: Tree/year

Medium_Trees(t) = Medium_Trees(t - dt) + (sapling_maturation_rate -
medium_tree_maturation_rate) * dt

INIT Medium_Trees = 0

DOCUMENT: The number of medium size trees in tree nursery.

UNIT: Tree

medium_tree_maturation_rate = Medium_Trees/(AVERAGE_MATURATION_TIME/3)

DOCUMENT: The rate at which medium trees mature into harvestable trees. Note that the maturation time from a sapling to a harvestable tree must be split up over 3 stocks, thus the division by 3 equation.

UNIT: Tree/year

$$\text{Harvestable_Trees}(t) = \text{Harvestable_Trees}(t - dt) + (\text{medium_tree_maturation_rate} - \text{harvest_rate}) * dt$$

INIT Harvestable_Trees = 0

DOCUMENT: The number of trees ready to be cut down and sold in a nursery.

UNIT: Tree

$$\text{harvest_rate} = \text{Harvestable_Trees}/(\text{AVERAGE_MATURATION_TIME}/3)$$

DOCUMENT: The rate at which harvestable trees are cut down. Note that the average maturation time from a sapling to a harvestable tree must be split up over 3 stocks, thus the division by 3 in the equation.

UNIT: Tree/year

$$\text{AVERAGE_MATURATION_TIME} = 20$$

DOCUMENT: The average time it takes a sapling to grow into a full-sized harvested tree.

UNIT: year

9.4 Equations for Section 6: Factory-Distributor Model

$$\text{Goods_in_Factory}(t) = \text{Goods_in_Factory}(t - dt) + (- \text{shipment_rate_of_goods}) * dt$$

INIT Goods_in_Factory = 1000

DOCUMENT: The stock of goods in a factory.

UNIT: Widget

$$\text{shipment_rate_of_goods} = \text{PULSE}(100,0,1E6)$$

DOCUMENT: The shipment rate of goods is the input to the third-order shipping delay. For the example in section 6, a test of the model using a PULSE function was used to decide what order delay to use.

UNIT: Widgets/week

$$\text{Goods_in_Transit_1}(t) = \text{Goods_in_Transit_1}(t - dt) + (\text{shipment_rate_of_goods} - \text{flow_1_to_2}) * dt$$

$$\text{INIT Goods_in_Transit_1} = 0$$

DOCUMENT: The first stock of the delay.

UNIT: Widget

$$\text{flow_1_to_2} =$$

$$\text{Goods_in_Transit_1}/(\text{AVERAGE_DELAY_FROM_FACTORY_TO_DISTRIBUTOR}/3)$$

DOCUMENT: The flow of goods from the first to the second stock of the delay.

UNIT: Widget/week

$$\text{Goods_in_Transit_2}(t) = \text{Goods_in_Transit_2}(t - dt) + (\text{flow_1_to_2} - \text{flow_2_to_3}) * dt$$

$$\text{INIT Goods_in_Transit_2} = 0$$

DOCUMENT: The second stock of the delay.

UNIT: Widget

$$\text{flow_2_to_3} =$$

$$\text{Goods_in_Transit_2}/(\text{AVERAGE_DELAY_FROM_FACTORY_TO_DISTRIBUTOR}/3)$$

DOCUMENT: The flow of goods from the second to the third stock of the delay.

UNIT: Widget/week

$$\text{Goods_in_Transit_3}(t) = \text{Goods_in_Transit_3}(t - dt) + (\text{flow_2_to_3} - \text{arrival_rate_of_goods}) * dt$$

INIT Goods_in_Transit_3 = 0

DOCUMENT: The third stock of the delay.

UNIT: Widget

arrival_rate_of_goods =

Goods_in_Transit_3/(AVERAGE_DELAY_FROM_FACTORY_TO_
DISTRIBUTOR /3)

DOCUMENT: The arrival rate of goods is the outflow of the third-order shipping delay with an input of the shipment rate of goods.

UNIT: Widget/week

Goods_at_Distributor(t) = Goods_at_Distributor(t - dt) + (arrival_rate_of_goods) * dt

INIT Goods_at_Distributor = 0

DOCUMENT: The stock of goods at the distributor that is not part of the third-order delay.

UNIT: Widget

AVERAGE_DELAY_FROM_FACTORY_TO_DISTRIBUTOR = 3

DOCUMENT: The average time it takes for a good to reach the distributor once it has been shipped out of the factory. The average delay is divided evenly over the three stocks of the delay.

UNIT: week