

MASSACHUSETTS INSTITUTE OF TECHNOLOGY

Departments of Electrical Engineering, Mechanical Engineering, and the Harvard-MIT Division
of Health Sciences and Technology

6.022J/2.792J/BEH.371J/HST542J: Quantitative Physiology: Organ Transport Systems

CONTROL AND INTEGRATION IN THE CARDIOVASCULAR SYSTEM

Text Reference: pages 144-166

CONTROL AND INTEGRATION IN THE CARDIOVASCULAR SYSTEM

A. Introduction

The purpose of the cardiovascular system is to deliver oxygen and other nutrients to the tissues of the body—particularly to the brain and heart. In general, the amount of blood flow to a particular organ is dynamically adjusted to meet its current metabolic need. The cardiovascular control systems operate to establish the proper cardiac output and to assure its optimal distribution to the various organs of the body. The highest priority is to assure adequate perfusion of the brain, and if necessary blood flow will be shunted from less critical organs to the brain.

Figure 1 demonstrates that as the body's rate of oxygen utilization increases, the cardiac output must increase in order to deliver the O_2 to the tissues, assuming the arterio-venous oxygen content difference is constant.¹ In steady state, the rate of oxygen uptake, \dot{V}_{O_2} , is equal to the cardiac output, Q , multiplied by the arterio-venous difference in oxygen content. Experimental evidence is shown in Figure 2, demonstrating the relationship between cardiac output and oxygen consumption at various levels of physical exercise.

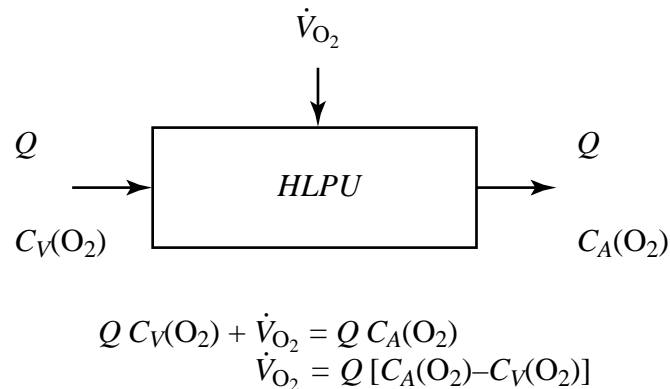

Figure 1: Conservation of Mass Relationship

The cardiovascular control system is constantly challenged by a wide variety of physical and physiological stresses. Some are transient and require rapid adaptive responses, while other stresses are more chronic and require slower (and more permanent) compensatory mechanisms. Table 1 presents a representative list of challenges to the cardiovascular system. Adaptive responses to challenges acting within seconds (such as standing or running) are mediated primarily by the autonomic nervous system. Hormonal controls act within minutes to days, and would be expected to play an important role in challenges such as blood loss, myocardial damage, or dehydration. Long-term adaptations are required in response to long-term stresses such as severe physical training or high altitude living, and generally result in physical remodeling of tissue such as myocardium and/or blood vessels.

Cardiovascular control is best understood in the context of the parallel anatomical arrangement of organs as illustrated in Figure 3. The figure demonstrates that *if the pressure in the aorta is main-*

¹While this assumption is not strictly true, it is reasonable for most normal operating ranges of cardiac output.

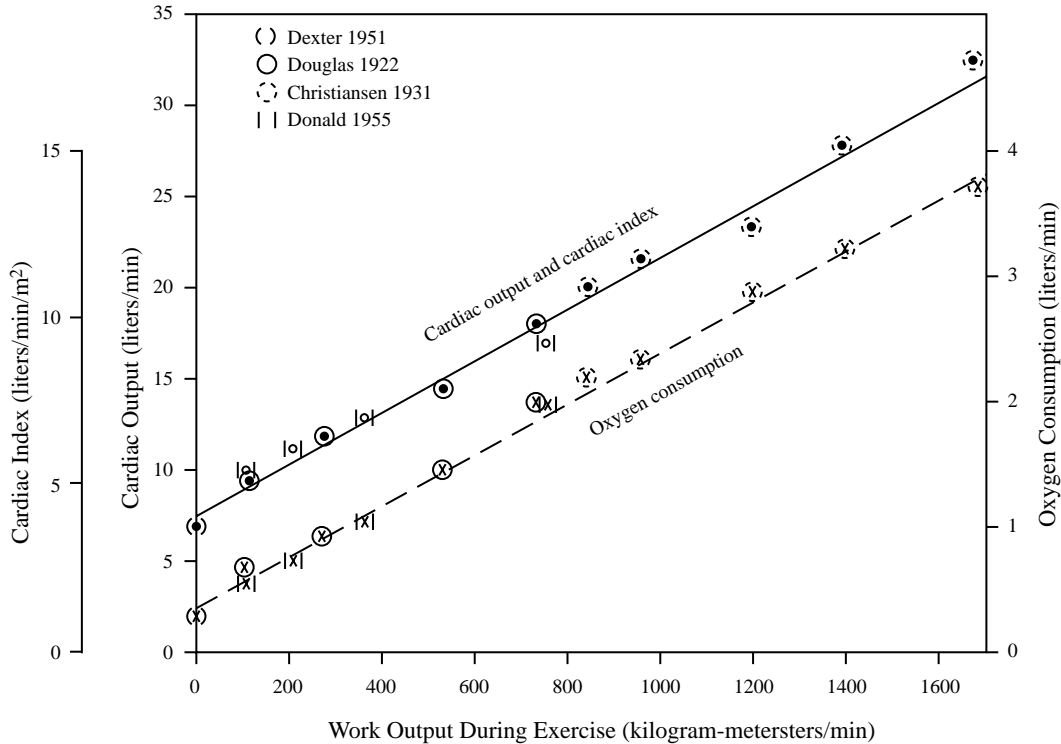

Figure 2: Relationship between cardiac output and work output (solid curve) and between oxygen consumption and work output (dashed curve) during exercise. [Data derived from studies by Douglas and Haldane (1922); Christensen and Mitteilung (1931); Dexter, Whittenberger, Haynes, Goodale, Gorlin, and Sawyer (1951); and Donald, Bishop, Cumming, and Wade (1955). After Figure 1-1 in Guyton, A., C. Jones, and T. Coleman. *Circulatory Physiology: Cardiac Output and its Regulation*. 2nd ed. Philadelphia: W.B. Saunders, 1973.

Table 1: Challenges to the CV System

Seconds to Minutes	Minutes to Hours	Hours to Days	Weeks to Months
<ul style="list-style-type: none"> · Standing up · Eating a big meal · Running for the bus 	<ul style="list-style-type: none"> · Fever · Blood loss · Myocardial infarction 	<ul style="list-style-type: none"> · Extreme heat, cold · Fluid deprivation · Space flight 	<ul style="list-style-type: none"> · Long-term space flight · Marathon training · High altitude living

tained at constant level, then the blood flow through individual organs can be established uniquely by the resistance of the vasculature through that organ. As we will see, a complex neurohumoral control system is used to maintain a constant aortic pressure and to adjust the network of parallel resistances.

The control of the cardiovascular system is complex, and involves numerous biochemical, neurological and hormonal mechanisms. The flow of blood to a particular vascular bed depends on the proper regulation of the cardiac rate and contractility, the intravascular volume, the venous tone, and arteriolar resistance. Some control mechanisms are quite local, and modulate arteriolar resistance in response to the metabolic needs of the immediately adjacent tissue. These mechanisms are not dependent on the autonomic nervous system or hormones, but are *intrinsic* to the local vascular

bed. This intrinsic regulatory mechanism is called *autoregulation*, and plays an important role in most organs. *Extrinsic* regulatory mechanisms depend on complex neurohumoral mechanisms, and integrate the function of heart, kidney, and vasculature.

Vascular smooth muscle plays a central role in both intrinsic and extrinsic regulatory mechanisms since it controls arteriolar and pre-capillary resistance, and also modifies the zero-pressure filling volume of the veins. Hence, we will next discuss some aspects of the physiology of vascular smooth muscle.

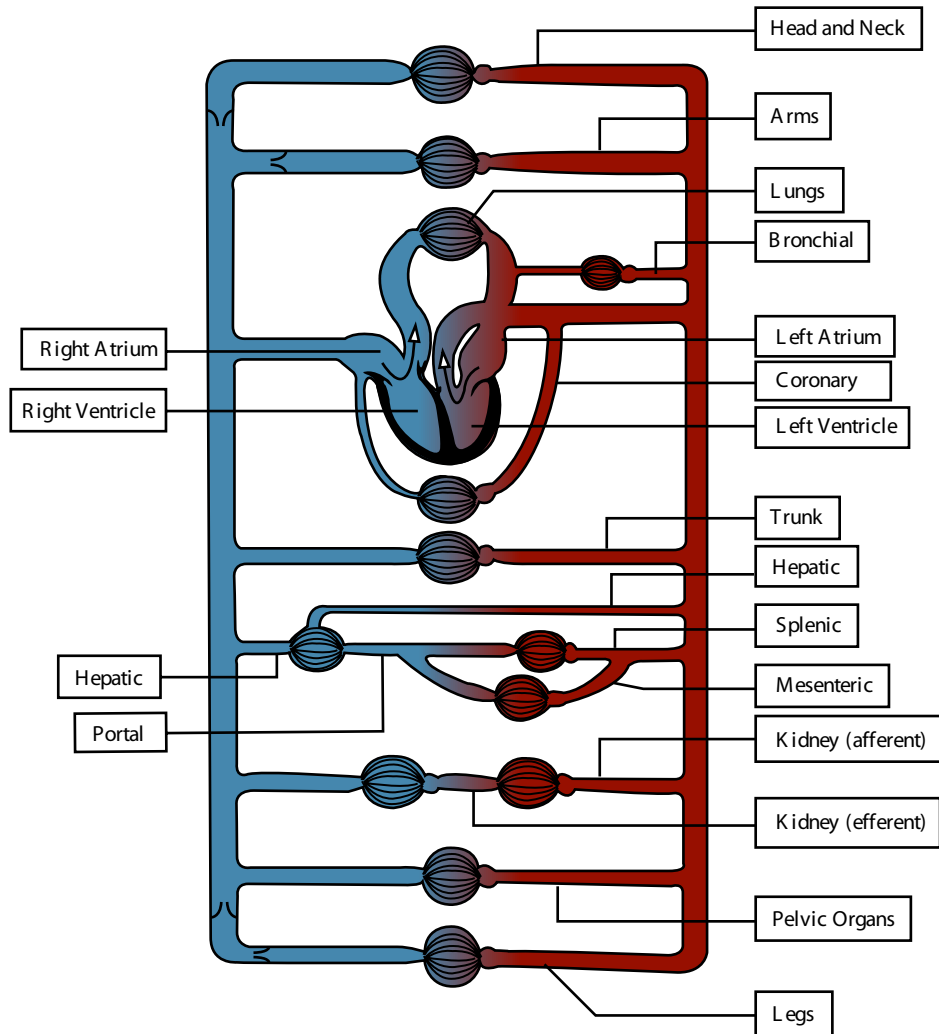

Figure by MIT OCW. After Green, H. D. In *Medical Physics* Vol. 1, Glasser, O. (ed.). Chicago: Year Book Medical Publishers, 1944.

Figure 3: Schematic diagram of the parallel and series arrangement of the vessels composing the circulatory system. The capillary beds are represented by thin lines connecting the arteries (on the right) with the veins (on the left). The crescent-shaped thickenings proximal to the capillary beds represent the arterioles (resistance vessels). (Redrawn from Green, H. D.: In Glasser, O., editor: *Medical Physics*, vol. 1, Chicago, 1944, Year Book Medical Publishers, Inc.)

B. Smooth Muscle

Introduction

Smooth muscle is present in the walls of most hollow organs of the body, such as the GI tract, bladder, uterus, gall bladder, ureters, and blood vessels (except capillaries). Smooth muscle is also present elsewhere in the body, e.g. in the eye where it controls pupil size, or in the hair follicles where it causes “hair-raising”. Changes in smooth muscle tension offset changes in internal pressure, and/or control the diameter of hollow organs. In the GI tract smooth muscle coordinates peristalsis. In arterioles smooth muscle controls the resistance to blood flow. In venules and veins, smooth muscle controls the amount of blood stored—the zero-pressure filling volume. Smooth muscle is, therefore, of central importance to the control of the cardiovascular system, and is central to the understanding of autoregulation.

Smooth muscle cells are characteristically spindle-shaped with single centrally-placed nuclei, and are typically organized into sheets. They contain the same basic contractile proteins as skeletal and cardiac muscle: actin and myosin, but rely on different regulatory proteins (calmodulin instead of troponin). In smooth muscle the contractile elements are not organized into the regular pattern of sarcomeres that result in the characteristic striations of skeletal and cardiac muscle. (Hence the name “smooth” muscle.) The smooth muscle contractile apparatus is demonstrated schematically in Figure 4. Bundles of actin filaments are attached to “dense bodies”, some of which are adherent to the cell membrane. Smaller numbers of thicker myosin filaments are scattered among the actin fibers. Cross-bridges form between actin and myosin heads, and cyclic conformational changes in the myosin result in contraction.

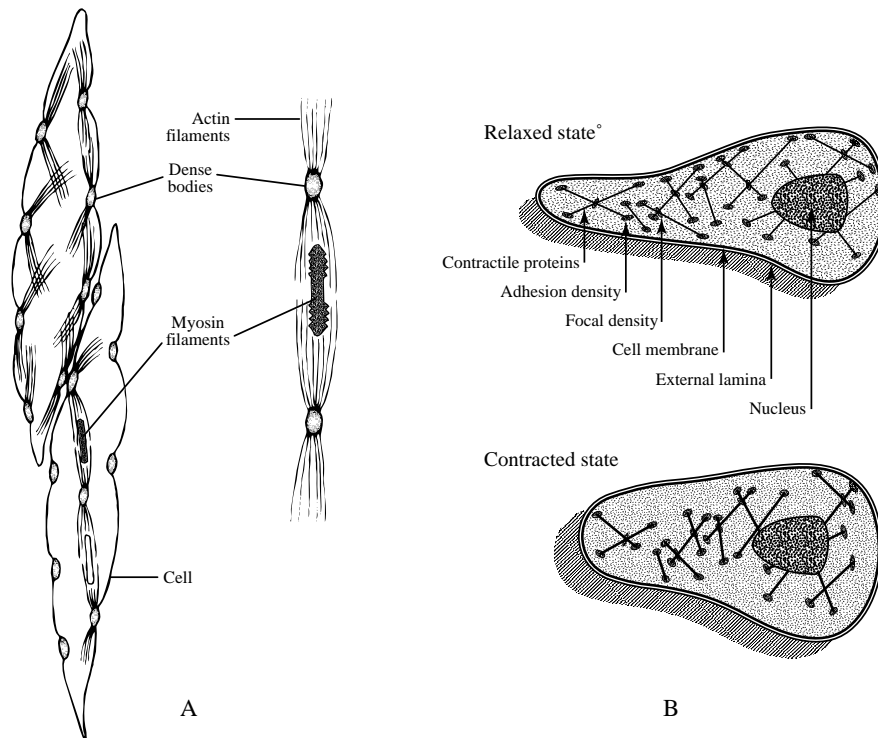

Figure 4: Cartoons of smooth muscle cell. A. Physical structure of contractile elements. B. Contractile function.

Types of smooth muscle

There are two types of smooth muscle in the body: 1) *single-unit* or *visceral* type, and 2) *multi-unit* type. Single-unit smooth muscle is so-named because the individual cells are tightly coupled both mechanically (via desmosomes that transmit mechanical force) and electrically (via low-resistance gap junctions that transmit action potentials from cell to cell). Hence, single-unit cells function as a syncytium, much like cardiac muscle. Single-unit smooth muscle is found in most hollow visceral organs and tubular structures of the body, including blood vessels. Single-unit smooth muscle cells exhibit the property of autorhythmicity, resulting in spontaneous rhythmic action potentials and contractions that spread from cell to cell. The frequency of firing is increased by stretch. Figure 5 shows the spontaneous activity of visceral smooth muscle and that increased stretch results in increased frequency of action potentials. Hormones from the sympathetic nervous system (norepinephrine) also cause increases in frequency of action potentials and increased muscle tension. Under normal conditions visceral smooth muscle maintains a constant tension, or *tone*, that is particularly important in the GI tract and in the vascular system.

Multi-unit smooth muscle tissue is composed of cells that act as independent units. Each cell is individually innervated, and the mechanical activity of the muscle is coordinated by nerve fibers. Multi-unit smooth muscle is found in such structures as the sphincter and ciliary muscles of the eye that control pupil size, the large arteries, and in the piloerector muscles that cause erection of the hair and “goose-bumps”. Multi-unit smooth muscle cells are not tonically active, do not respond to stretch, and are activated only via autonomic neural activity.

Contractile mechanisms

Contraction of smooth muscle is triggered by a sequence of biochemical events initiated by an increase in the concentration of calcium in the cytoplasm. In common with skeletal and cardiac muscle, contraction is initiated by a rise in intracellular calcium concentration from about 100 nM (relaxed) to 700 nM. There are major differences between the two types of muscle, however, in the biochemical processes that control contraction, and also in the contractile dynamics. A complex array of electrical, mechanical, and humoral signals controls the intracellular calcium level. Although the major features are understood, unraveling the detailed mechanisms of smooth muscle physiology is still an active research area.

How does intracellular calcium control contraction in smooth muscle?

The contraction of smooth muscle is accomplished by the same basic actin-myosin sliding filament machinery as in other muscle types. The myosin head attaches to the actin filament, changes its configuration—thereby shortening the actin-myosin structure—then releases itself and repeats the cycle. In order to bind to actin, the myosin head must be phosphorylated. The phosphorylation step cannot take place, however, without the presence of the activated form of the enzyme *myosin light-chain kinase* (MLCK) in the presence of ATP. The MLCK is activated by the regulatory protein *calmodulin*, provided it has been bound to calcium. The concentration of intracellular calcium, therefore, is critical in initiating smooth muscle contraction. Figure 6 reviews the sequence of biochemical events leading to contraction, and Figure 7 illustrates in cartoon form the biochemical pathways leading to smooth muscle contraction. Notice that the level of intracellular calcium

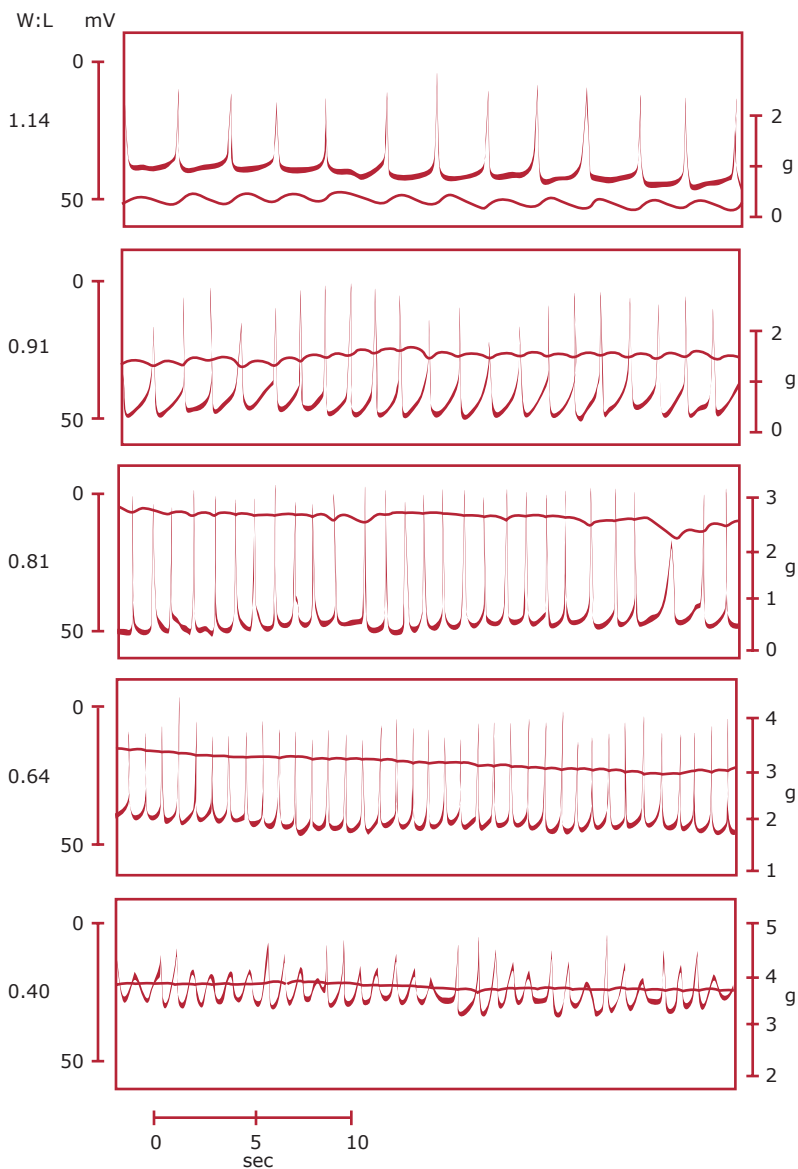

Figure by MIT OCW.

Figure 5: Action potentials and tension in a strip of intestinal smooth muscle showing increased frequency of spontaneous action potentials in response to increased tension.

determines the amount of available activated MLCK. Note also that smooth muscle contraction is controlled by calcium-mediated changes in the *myosin thick filaments* in contrast to skeletal and cardiac muscle where the calcium-mediated changes occur in the thin actin filaments. Another contrast between smooth muscle and striated muscle is that the latter contracts only in response to an action potential that triggers calcium entry into the cytosol from outside the cell and from the SR. Smooth muscle cells also develop tension in response to an action potential, but may also contract in response to calcium concentration increases caused by the opening of ligand- or stretch-mediated calcium channels.

The *dynamics* of smooth muscle contraction are two to three orders of magnitude slower than in skeletal and cardiac muscle. The rate of attachment cycling of the myosin cross-bridges to actin

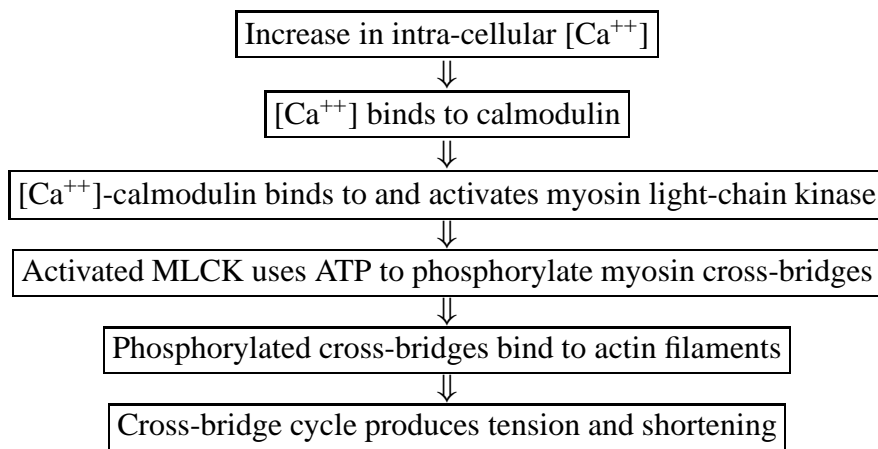

Figure 6: Biochemical events leading to smooth muscle contraction

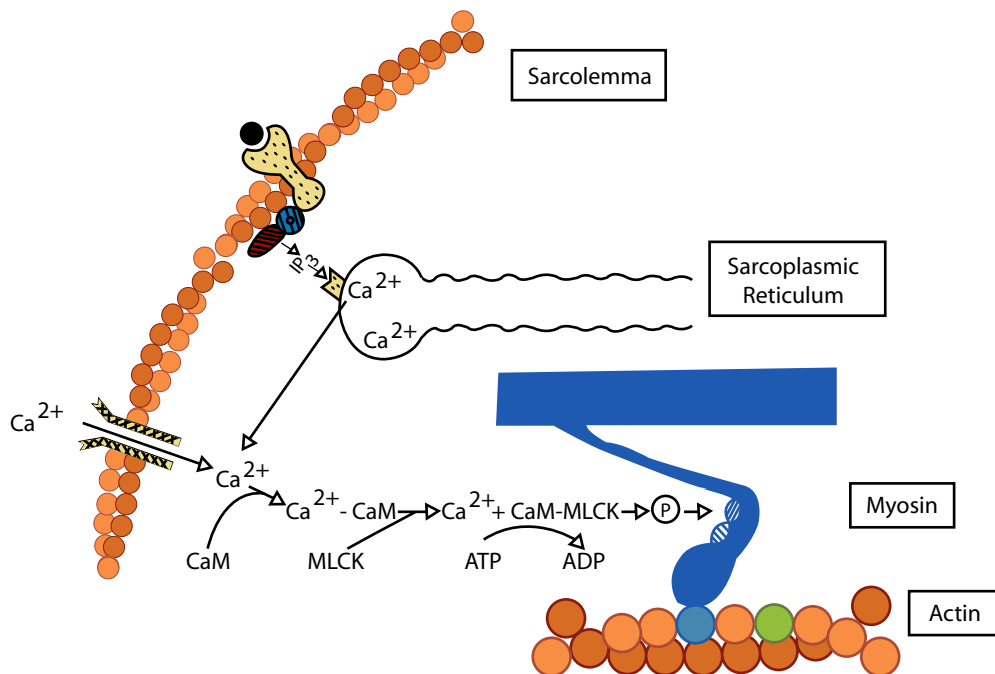

Figure by MIT OCW. After Barany, M. *Biochemistry of Smooth Muscle Contraction*. Academic Press, 1996.

Figure 7: Mechanism of Smooth Muscle Contraction. Calcium enters the cytoplasm through voltage or ligand gated membrane channels, or it can be released from intracellular stores in the sarcoplasmic reticulum (SR). Intracellular store calcium release involves stimulating ligand activation of a series of second messengers to produce inositol triphosphate IP_3 . IP_3 binds to Ca^{2+} receptors on the SR membrane and increases cytoplasmic $[Ca^{2+}]$. When cytoplasmic calcium reaches a threshold, contraction is initiated. Intracellular Ca^{2+} forms complexes with calmodulin (CaM); a regulatory protein that activates the myosin light chain kinase (MLCK), which in turn phosphorylates one of the light chains of the myosin molecule and allows the myosin head to bind the actin filament, causing muscle contraction. (From Barany, M. *Biochemistry of Smooth Muscle Contraction*. Academic Press, 1996).

is slow, and this results in slower development of shortening and tension. Significantly, however, the energy required to *maintain* tension in smooth muscle is much less than in striated muscle. A muscle “twitch” may last from 3 to 30 seconds in smooth muscle, and in fact the smooth muscle in many organs—including blood vessels—maintains indefinitely a continuous (or tonic) contraction with minimal energy expenditure. The ability of smooth muscle to maintain tension with minimal

energy expenditure is called the “latch” phenomenon. A possible mechanism is that the myosin remains bonded to the actin but stops cycling.

Relaxation of smooth muscle occurs when the myosin heads are dephosphorylated. This is accomplished by the action of myosin light-chain phosphatase, an enzyme that is always present and active in the cytosol. If the level of activated Ca^{++} -calmodulin-MLCK drops, then the phosphatase will dominate and dephosphorylation of myosin will occur. Since $[\text{Ca}^{++}]_{in}$ controls the amount of activated MLCK, the calcium concentration is able to control muscle contraction and relaxation. *So the key to controlling smooth muscle contraction is the control of intracellular calcium concentration.*

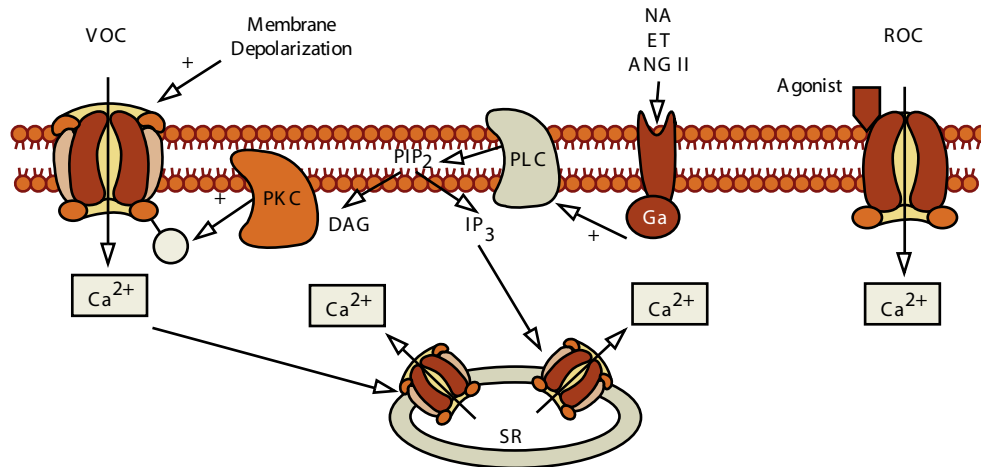

Figure by MIT OCW.

Figure 8: Agonists such as norepinephrine (NA), endothelin (ET), and angiotensin II (ANG II) stimulate Ca^{++} release from the sarcoplasmic reticulum by binding G protein coupled receptors, activating phospholipase C (PLC) and causing inositol triphosphate (IP_3) formation. Calcium can also enter the cytoplasm through receptor operated channels (ROC) or voltage operated channels (VOC).

How is intracellular calcium concentration controlled?

Calcium can enter the cytoplasm of smooth muscle cells in two ways: it can flow down its concentration gradient from outside of the cell through specific transmembrane channels, or it can be released into the cytoplasm from internal stores in the sarcoplasmic reticulum. Similarly, calcium can be removed from the cytoplasm by actively pumping it out of the cell, or into the intracellular reservoirs of the sarcoplasmic reticulum. At any time, therefore, the intracellular calcium concentration is established by the balance between calcium inflow and outflow. The channels and pumps in the cell membrane and SR are complex, and are controlled by a wide variety of electrical, mechanical, and humoral factors.

The sarcoplasmic reticulum (SR) is a storage depot for calcium within the cell. Release of SR calcium into the cytoplasm is controlled by a second messenger system triggered by hormones or neurotransmitters that attach to specific receptors on the cell membrane. For example, the sympathetic neurotransmitter norepinephrine binds to the α_1 adrenoceptor on the cell membrane and initiates a sequence of reactions mediated by G proteins resulting in the formation of inositol triphosphate (IP_3) that binds to a specific receptor on the SR, causing release of Ca^{++} into the

cytoplasm. (See Table 2 and Figure 8.) The SR membrane also contains active pumps that transport intracellular Ca^{++} back into the SR.

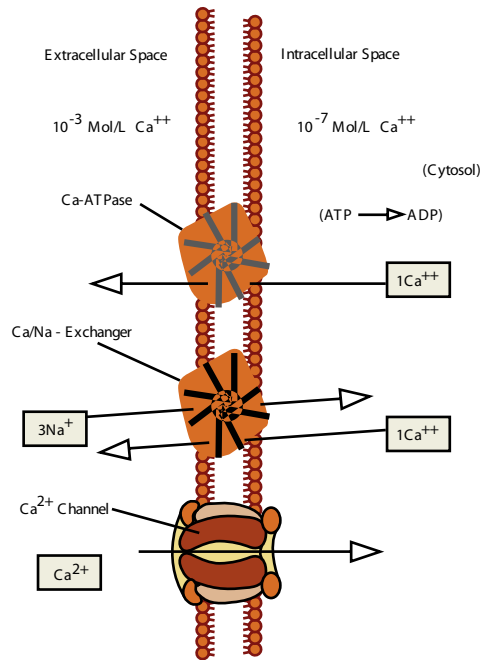

Figure by MIT OCW.

Figure 9: Control of calcium across the cell membrane (see text).

Calcium movement across the cell membrane is controlled by pumps that move calcium out of the cell, and by calcium channels that control its inflow into the cell. (See Figure 9.) There are two sarcolemma calcium pumps. One is powered by ATP and moves calcium ion out of the cell against its electrochemical gradient. The second pump is the $\text{Ca}^{++}/\text{Na}^+$ exchanger in which one Ca^{++} is moved out of the cell in exchange for 3 Na^+ ions moving in. The energy for this pump is derived from the sodium electrochemical gradient. The calcium channels, when open, permit calcium to flow down its electrochemical gradient into the cell. There are three types of calcium channels:

1. voltage-dependent channels in which the permeability of the channel is controlled by the membrane potential (tension is roughly proportional to the degree of membrane depolarization in a continuous manner, see Figure 10);
2. receptor-operated channels that are opened when an agonist binds to the channel receptor; and
3. stretch-activated channels that respond to mechanical deformation of the cell.

Clearly the mechanical behavior of smooth muscle is incredibly complex, and is under the control of a host of mechanical, electrical, and humoral factors, many of which interact. Thus, the smooth muscle cell integrates many different inputs. Some signals may be carried from distant locations by nerve impulses or by hormones (norepinephrine, epinephrine, vasopressin, angiotensin II etc.), while other signals ($[\text{H}^+]$, adenosine, etc.) may reflect the metabolic state of

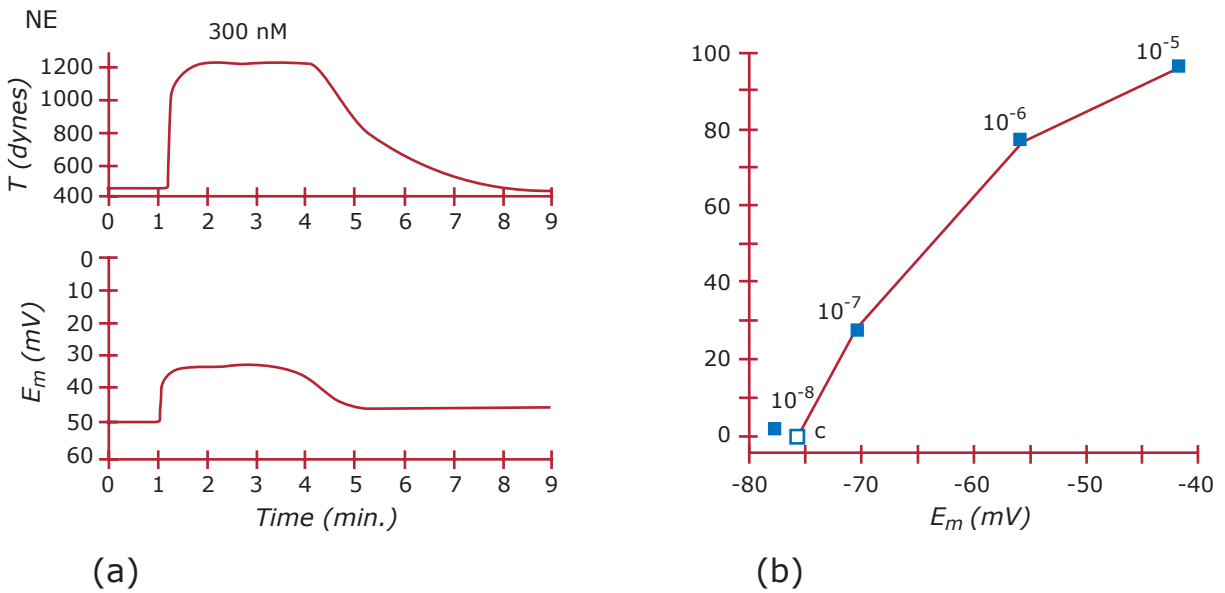

Figure by MIT OCW.

Figure 10: Relationship between membrane potential and artery tone. A. Graded depolarization and corresponding tension allow a steady state tone to be developed in response to norepinephrine stimulation. The tracings (left) illustrate a typical relationship between artery tension and membrane potential (E_m). Both E_m and tension levels can be maintained relatively constant for many minutes during stimulation by vasoconstrictors. B. Different doses of norepinephrine causes various degrees of depolarization, allowing experimental measurement of the relationship between tension (% of max) and membrane potential (mV). (From Sperelakis, N. *Cell Physiology Source Book*. Academic Press, 1995: 568 and 570.)

immediately adjacent tissues. Indeed, in contrast with skeletal muscle, nervous input to smooth muscle does not elicit a “twitch”, but will simply modulate the mechanical response in combination with other signals. For example, during exercise the level of sympathetic nervous stimulation is high, but vascular smooth muscle in exercising muscle beds will *dilate* in response to overwhelming humoral input from local tissues. [Local autoregulation dominates the sympathetic neuronal input.]

Table 2 summarizes some (but not all) of the myriad complex factors and mechanisms that control vascular smooth muscle contraction.

Table 2: Factors and Mechanisms that Control Smooth Muscle Contraction

Activator/ligand	Channel/Receptor	Effect on VSM	Mechanism
Stretch	Stretch-activated Ca ⁺⁺ channels	Contraction	Stretch opens channels, allowing Ca ⁺⁺ to enter cytoplasm
Membrane depolarization	Voltage-gated Ca ⁺⁺ channels	Contraction	↑Ca ⁺⁺ influx as membrane is depolarized
Norepinephrine— (humoral or neurotransmitter)	α ₁ adrenoceptors	Constriction	Activates phospholipase C (PLC) causing formation of inositol triphosphate (IP ₃) that stimulates SR to release calcium into cytoplasm
Angiotensin II	A-II receptors	Constriction	Same as above
Endothelin (ET-1)	ET _A receptors	Constriction	Same as above
Acetylcholine	Muscarinic receptor	Constriction	Same as above
Membrane hyperpolarization	K ⁺ channels	Relaxation	Membrane hyperpolarization closes Ca ⁺⁺ channels
Epinephrine	β ₂ receptors	Relaxation	Stimulates adenylyl cyclase via G-protein to produce increased levels of cAMP that inhibits activity of MLCK and leads to relaxation.
Atrial natriuretic protein (ANP)		Relaxation	Same as above
ATP, Adenosine	ATP receptor	Relaxation	Same as above
↓O ₂ , ↑CO ₂ , ↑[H ⁺] ↑[K ⁺], lactic acid		Relaxation	
Nitric Oxide (NO)	Diffuses into cell	Relaxation	Activates guanylyl cyclase to form ↑cGMP that causes relaxation by: <ol style="list-style-type: none"> 1. decreasing permeability of Ca⁺⁺ channels, 2. hyperpolarizing membrane by increasing permeability of K⁺ channels, 3. IP₃ that reduces Ca⁺⁺ release from SR, 4. Ca⁺⁺ pump activity to lower calcium concentration.

C. Intrinsic Regulation—Autoregulation

Introduction

In many organs blood flow appears to be regulated to meet the immediate metabolic needs of the tissue, such that even under wide variations of perfusion pressure flow is adjusted appropriately. This behavior is independent of neurohumoral control, yet clearly involves changes in vascular resistance. The phenomenon is referred to as *autoregulation*, and is illustrated in Figure 11. Skeletal muscle in the hind limb of a dog was isolated from the rest of the animal, and was perfused from a constant pressure source. The metabolic state was constant. From a baseline of 100 mmHg the perfusion pressure was suddenly increased or decreased, and the flow rate was monitored. The flows immediately following the pressure changes (transient flows) are plotted as open circles. The steady-state flows (after 30-60 seconds) are plotted as closed circles. Notice that in response to a step increase in perfusion pressure from 100 mmHg to 120 mmHg the flow increases immediately from 2 to 6 ml/min/100gm of tissue. The immediate increase in flow is partly explained by the increase in perfusion pressure, and partly due to a significant decrease in vascular resistance. The resistance at baseline is $100/2 \sim 50$ mmHg/ml/min. The resistance immediately after the step in perfusion pressure drops to $120/6 \sim 20$ mmHg/ml/min. The decrease in resistance is caused by dilation of the arteries and arterioles by the increased transmural pressure. However, the flow then drops back to nearly the original flow rate, and the estimated resistance increases to $120/2.2 \sim 54$ mmHg/ml/min; slightly higher than at baseline. When perfusion pressure dropped to 50 mmHg, flow actually ceased, suggesting that the arterioles actually developed infinite resistance due to collapse. However, during the following 30 seconds or so, the flow was re-established and approached the baseline level. Clearly the arterioles in this experimental preparation are not behaving as passive elastic conduits! Rather, they appear to develop increased wall tension (“tone”) after being stretched by an increase in transmural pressure, and to relax and increase in diameter after their initial constriction (or even collapse) due to a sudden decrease in transmural pressure.

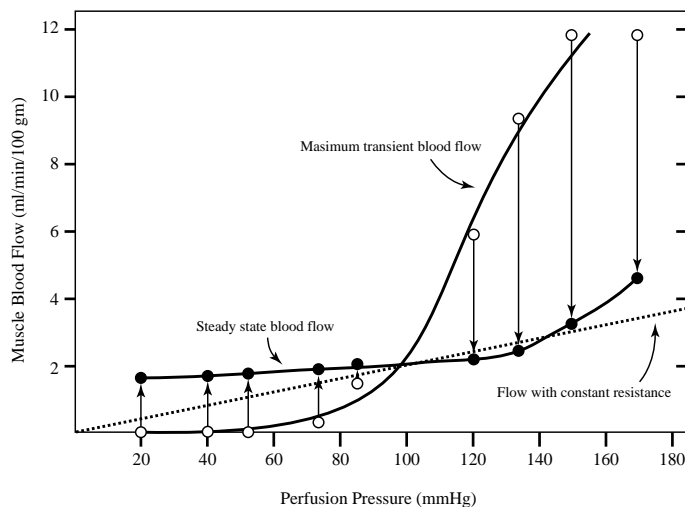

Figure 11: Pressure-flow behavior in the isolated hind limb of a dog. The open circles represent flow immediately following step changes in perfusion pressure. The closed circles represent steady state flow rates. The dotted line represents the flow-pressure relationships for a constant vascular resistance of 50 mmHg/(ml/min)

The temporal dynamics of autoregulation in the hindlimb are illustrated in Figure 12 that shows perfusion pressure, blood flow, and vascular resistance as a function of time after a step increase and decrease in perfusion pressure. Notice that in response to a step increase in pressure the steady

state resistance increases in order to maintain flow close to its original value, and vice versa for the pressure drop.

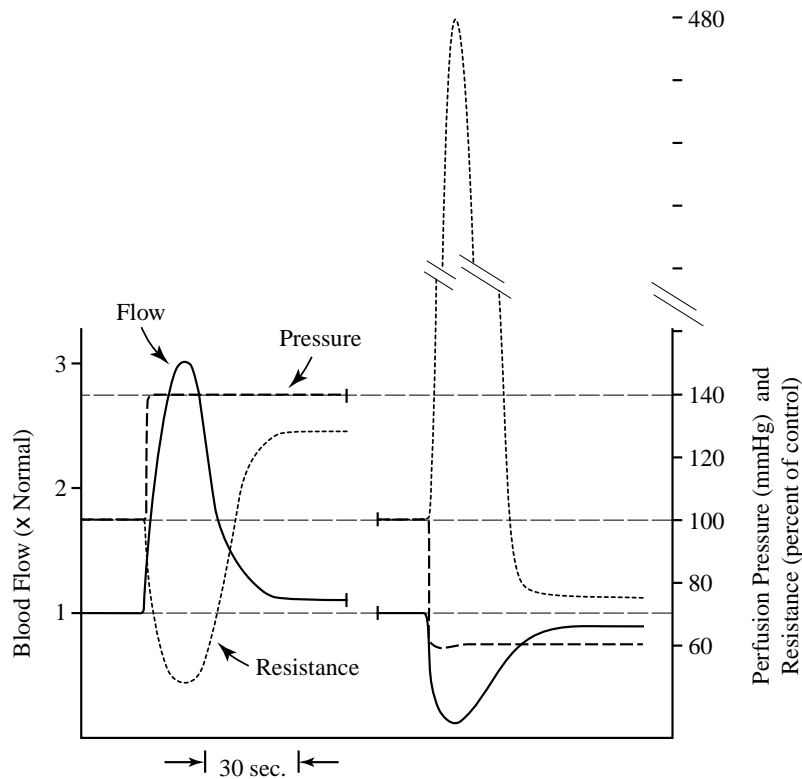

Figure 12: Autoregulation in the hindlimb when the perfusion pressure is increased and decreased. Hindlimb blood flow is represented by the solid curve, perfusion pressure is indicated by the long-dashed curve, and the calculated resistance is indicated by the short-dashed curve. Note the rapidity of autoregulation when the perfusion pressure is either increased or decreased.

The phenomenon of autoregulation is seen in many organs, including the kidney, heart, and brain. Figure 13 illustrates autoregulation in the kidney. Renal blood flow remains remarkably constant between arterial pressures of 80 and 200 mmHg, as does the glomerular filtration rate. Renal autoregulation is not affected by denervation of the kidney, but adding drugs that paralyze smooth muscle abolishes it. The implication is that autoregulation is a local phenomenon that depends on the behavior of vascular smooth muscle in response to stretch. It is independent of the autonomic nervous system and furthermore, the data from the isolated hind limb experiment rule out dependency on circulating hormones.

Metabolically induced hyperemia

In the examples given, metabolic activity has been constant, as was the oxygen content of the perfusing blood. If metabolic activity of an organ increases, vascular resistance drops and the rate of blood flow to the organ increases (hyperemia). Figure 14 illustrates the effect of increased muscular activity on blood flow to the calf of the leg during rhythmic exercise. Note that during the relaxation phase of the exercise blood flow reaches levels of 15 times the control level. This effect is independent of the nervous system. The increase in blood flow to tissues during increased

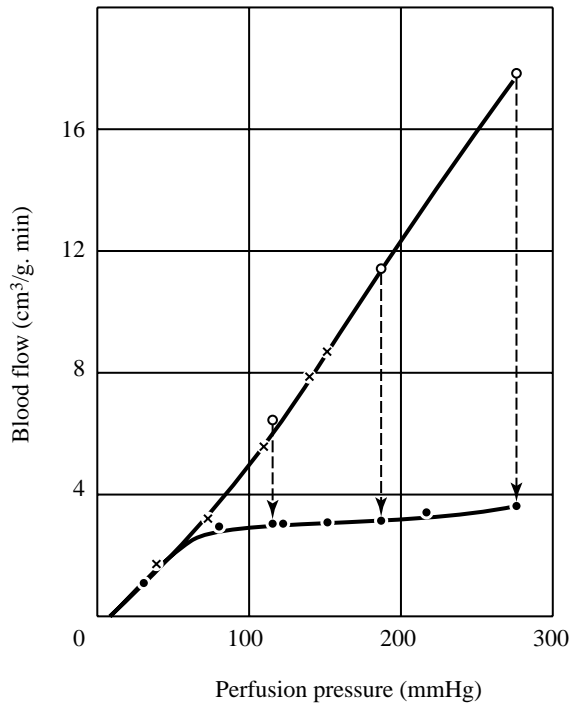

Figure 13: Immediate (x) and stabilized (•) pressure-flow curves for kidney.

metabolic activity is a general rule, and is observed in most organs. Cardiac output (blood flow to the entire body) increases in direct proportion to oxygen consumption, as was noted above in Figure 1. Blood flow increases in glands during active secretion, in the brain during neural activity, in the heart during increased cardiac work, in the GI tract during digestion, etc.

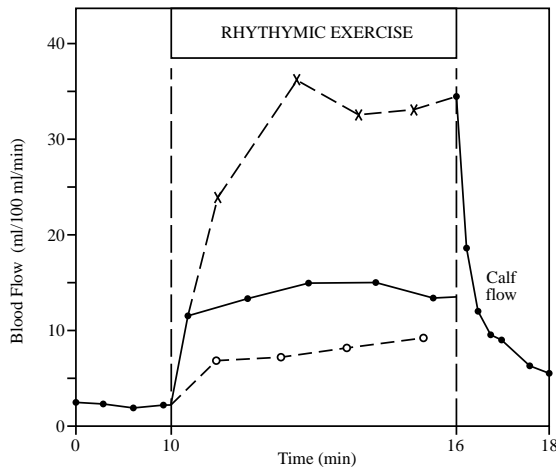

Figure 14: Effect of exercise on blood flow in the calf, illustrating the extreme dependence of blood flow on the degree of tissue activity. Dots = mean rate of flow; crosses = flow during a few seconds relaxation; circles = flow during sustained contraction. [Redrawn from Barcroft and Swann (1953).]

The resistance of a vascular bed responds to changes in the oxygen content of the perfusing blood in order to maintain an adequate rate of oxygen supply to meet the metabolic need of the tissue. Figure 15 demonstrates the increase in blood flow to the isolated hind limb of a dog when the oxygen saturation of the perfusing blood is dropped. Note that the time constant of the vascular response is in the order of 20–30 seconds. Autoregulation tends to maintain oxygen transport to the tissue despite the changes in blood oxygen saturation. These observations suggest that vascular resistance is modulated by molecules related to local tissue metabolism. A number of

candidates have been suggested, including CO_2 , O_2 , $[\text{H}^+]$ (lactic acid), $[\text{K}^+]$, and adenosine. Of these, adenosine seems most likely. A reduction in local pO_2 would lead to increased production of adenosine from ATP. The adenosine then diffuses to the adenosine receptor on vascular smooth muscle (VSM) resulting in smooth muscle relaxation and lowered vascular resistance.

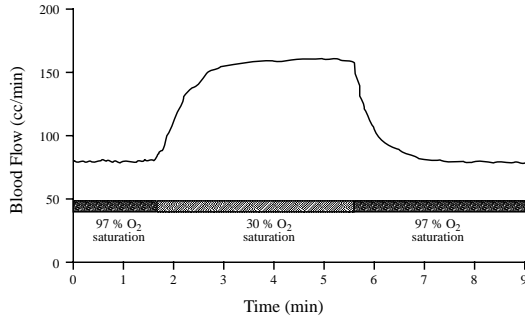

Figure 15: *Effect of acute changes in arterial oxygen saturation on arterial blood flow to the hind limb of a dog. Note especially the rapidity of the reaction (Crawford, 1959).*

Reactive Hyperemia

If blood flow to tissue is stopped completely (or reduced significantly below steady-state values) for a period of time (30 seconds to 10 minutes), and then the occlusion is removed, the blood flow will rise initially to very high levels, and then gradually return to normal. This phenomenon is known as *reactive hyperemia* and has been observed in most tissues—especially in skeletal muscle, cardiac muscle and skin, and is illustrated in Figure 16. The phenomenon suggests that vascular resistance is under the control of locally-produced vasodilatory metabolites that accumulate during ischemia, and then get “washed away” to normal levels after flow is restored. The longer the ischemic period, the more dramatic the reactive hyperemia.

Autoregulation may be responsible for the so-called “Anrep effect” in the heart. It is observed that when the ventricle is suddenly presented with an increased afterload the end-diastolic pressure suddenly rises (as one would expect), but as the afterload is maintained end-diastolic pressure slowly drops—evidence of increased ventricular contractility. Why? The reason seems to be that during the initial pressure rise there is a zone of relative ischemia in the endocardial myocardium. Autoregulation follows, with improved perfusion and concomitant improved mechanical performance.

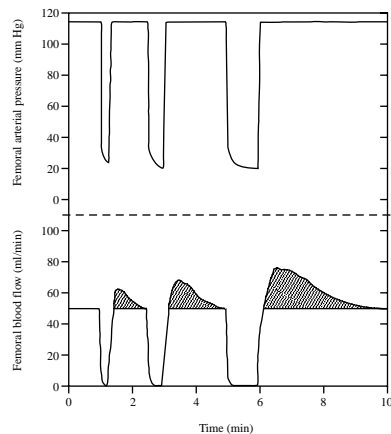

Figure 16: *Reactive hyperemia in the hindlimb of the dog after occlusions of 15, 30, and 60 seconds. The duration and amplitude of the response are proportional to the duration of the occlusion, suggesting a metabolic mechanism. Peak flow after the 60 second occlusion was 70% greater than control, and returned to control in about 110 seconds. (From Berne and Levy.)*

D. Extrinsic Regulation

Introduction

Autoregulation plays a significant role in the regulation of blood flow, but alone it is not sufficient. Rather, an elaborate extrinsic control system exists which involves a variety of sensors and effectors linked together via the autonomic and central nervous systems.

In general any control system must function to control some variable(s), and includes several functional components: 1) sensors or receptors to measure the controlled variable, 2) control logic, and 3) effector mechanisms. (See Figure 17.) In addition an appropriate communication system is required. What is the controlled variable in the cardiovascular system? Ultimately the system functions to regulate *tissue blood flow* such that metabolic demands are met. However, *tissue blood flow* per se is not actively sensed and controlled. Rather, the cardiovascular system regulates *arterial pressure* rather closely, and controls regional blood flow by varying the resistance of the vascular beds as necessary. In addition, the system regulates *blood volume* to within narrow limits, but the time constants of this control loop are longer.

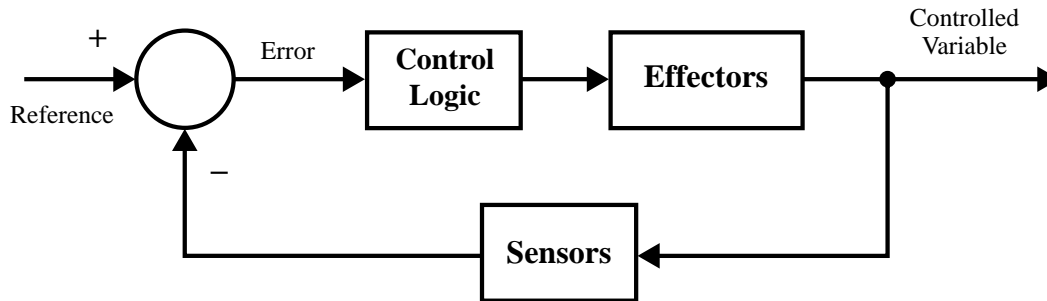

Figure 17: Block diagram of a control system

The Communication System: The Autonomic Nervous System

The autonomic nervous system coordinates and regulates many of the body's organ systems, and its operation is usually at an unconscious level. The autonomic nervous system can be divided into 1) afferent pathways, which carry information from organs to the brain, 2) centers in the central nervous system (spinal column or brainstem) which integrate autonomic responses, and 3) efferent pathways which carry information to the various organs. The efferent pathways have been subdivided into two sections—the *sympathetic* system and the *parasympathetic* system. A rough generalization would assign regulation of the base-line vegetative functions of the body to the parasympathetic nervous system, and the mobilization of the body for emergency situations to the sympathetic system. Thus parasympathetic activity increases GI motility, gastric secretion, etc. Sympathetic stimulation leads to increase in heart rate, rise in arterial pressure, and in general opposes parasympathetic effects. *Most organs are innervated by both systems, and the net balance of sympathetic and parasympathetic nervous activity determines the behavior of the organ.* Figure 18 is a diagram of the autonomic nervous system.

Note that the *sympathetic efferent fibers* exit from the central nervous system (brain and spinal cord) via the thoracic and lumbar spinal roots. The efferent pathway begins with a “preganglionic”

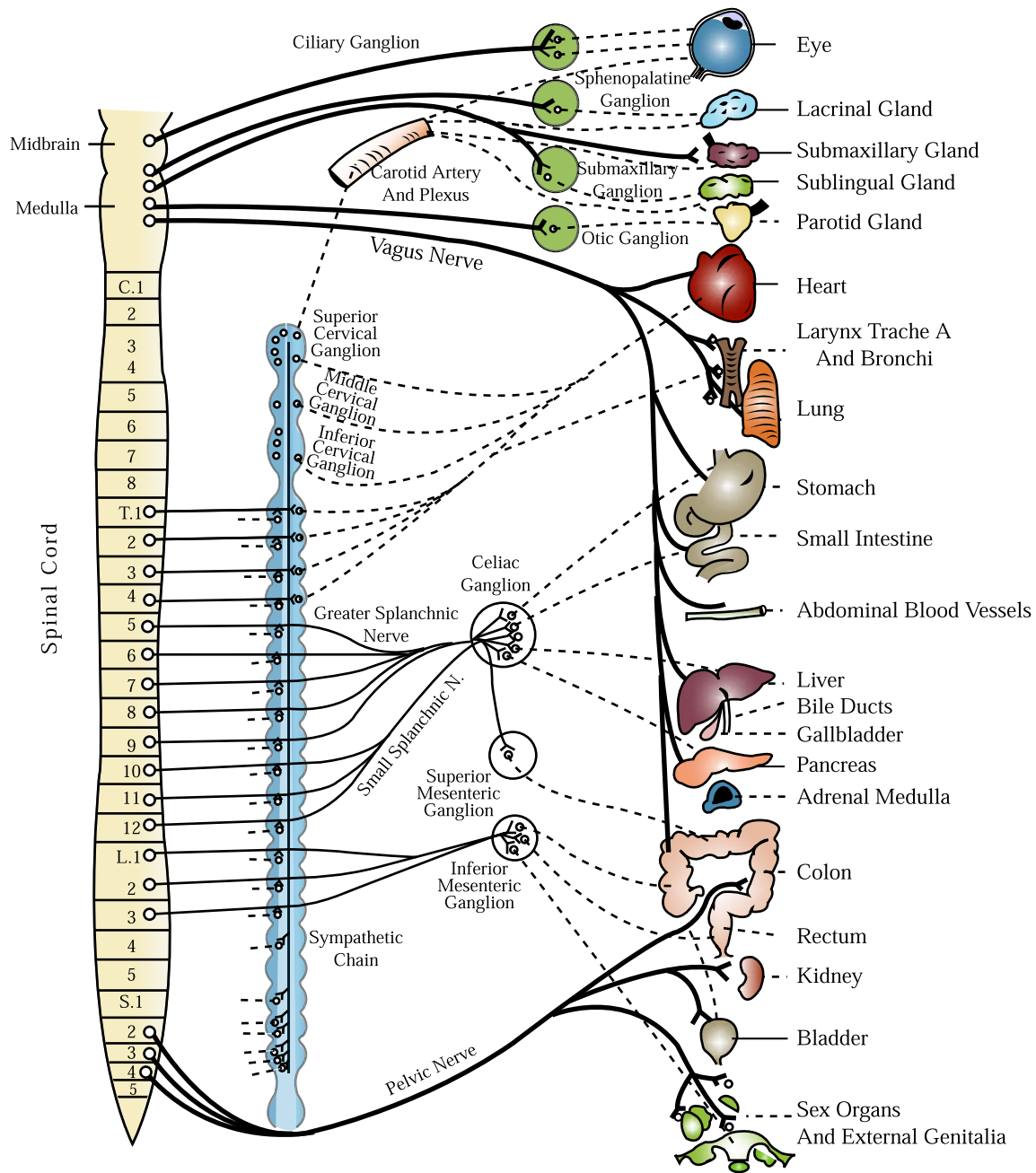

Figure by MIT OCW.

Figure 18: Diagram of the efferent autonomic pathways. Preganglionic neurons are shown as solid lines, postganglionic neurons as dotted lines. The heavy lines are parasympathetic fibers; the light lines are sympathetic.

axon whose nerve body lies within the spinal cord. This axon synapses with a “post-ganglionic” fiber that innervates the target organs. The synapses and postganglionic nerve bodies are located in clusters known as “ganglia”. Many sympathetic ganglia are located close to the spine, but others are more peripheral (e.g. the celiac ganglion). **Parasympathetic efferent fibers** exit from the CNS via the cranial nerves and via sacral spinal roots. The parasympathetic efferent fibers travel long distances to the vicinity of their target organs where they synapse with short post-ganglionic axons.

Figure 19 diagrams the neurotransmitters of the autonomic nervous system. Note that **acetyl-**

choline is the transmitter of the parasympathetic system and also of all ganglia. The acetylcholine receptors in both sympathetic and parasympathetic ganglia are of the “nicotinic” type, while the end-organ acetylcholine receptors are of the “muscarinic” type. The transmitter for the sympathetic nervous system is **norepinephrine**.

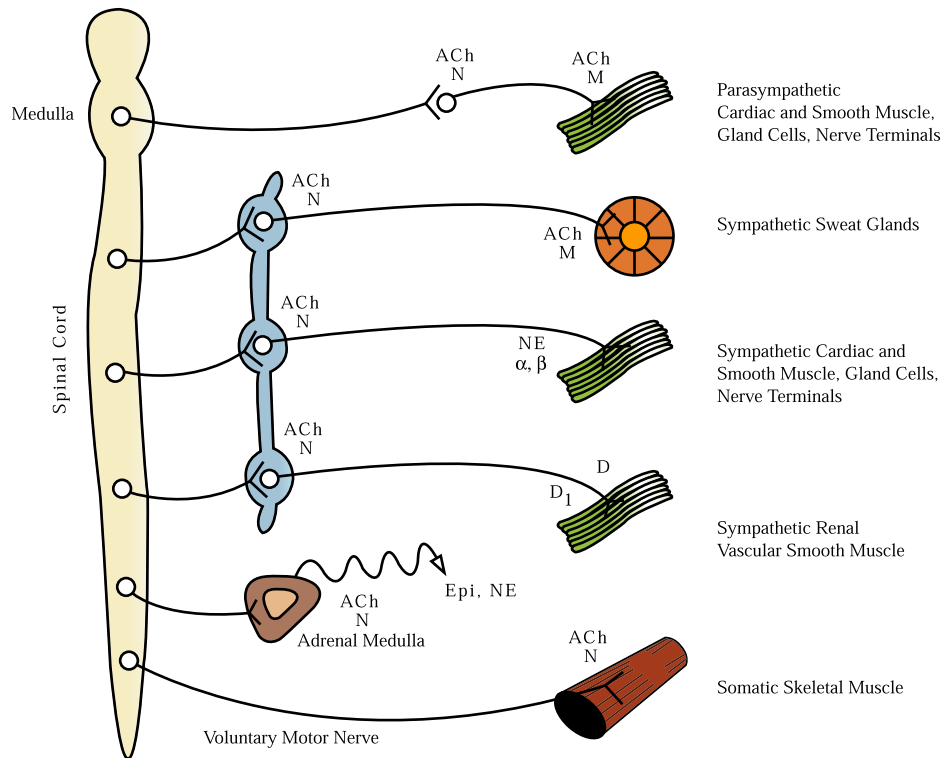

Figure by MIT OCW.

Figure 19: The general wiring of autonomic effector neurons including identification of neurotransmitter agents at different synapses

Table 3 documents the responses of various target organs to autonomic nervous stimulation. Note that most organs have innervation from both sympathetic and parasympathetic systems, and that the “operating point” of the target organ is established by the balance of the two opposing neural inputs.

Table 3: Responses of Effector Organs to Autonomic Nerve Impulses

EFFECTOR ORGANS	ADRENERGIC IMPULSES		CHOLINERGIC IMPULSES
	<i>Response Type</i>	<i>Responses</i>	<i>Responses</i>
<i>Eye</i>			
Radial muscle, iris	α	Contraction (mydriasis) ++	—
Sphincter muscle, iris		—	Contraction (miosis) +++
Ciliary muscle	β	Relaxation for far vision (slight effect)	Contraction for near vision +++
<i>Heart</i>			
S-A node	β	Increase in heart rate ++	Decrease in heart rate; vagal arrest +++
Atria	β	Increase in contractility and conduction velocity ++	Decrease in contractility, and (usually) increase in conduction velocity ++
A-V node	β	Increase in automaticity and conduction velocity ++	Decrease in conduction velocity; A-V block +++
His-Purkinje system	β	Increase in automaticity and conduction velocity +++	Little effect
Ventricles	β	Increase in contractility, conduction velocity, automaticity, and rate of idioventricular pacemakers +++	Slight decrease in contractility claimed by some
<i>Arterioles</i>			
Coronary	α, β	Constriction +; dilatation ++	Dilatation \pm
Skin and mucosa	α	Constriction +++	Dilatation
Skeletal muscle	α, β	Constriction ++; dilatation ++	Dilatation +
Cerebral	α	Constriction (slight)	Dilatation
Pulmonary	α, β	Constriction +; dilatation	Dilatation
Abdominal viscera; renal	α, β	Constriction +++; dilatation +	—
Salivary glands	α	Constriction +++	Dilatation ++
<i>Veins (Systemic)</i>	α	Constriction ++	—
<i>Lung</i>			
Bronchial muscle	β	Relaxation +	Contraction ++
Bronchial glands		Inhibition (?)	Stimulation +++
<i>Stomach</i>			
Motility and tone	α, β	Decrease (usually) +	Increase +++
Sphincters	α	Contraction (usually) +	Relaxation (usually) +
Secretion		Inhibition (?)	Stimulation +++
<i>Intestine</i>			
Motility and tone	β	Decrease (usually) +	Increase +++
Sphincters	α	Contraction (usually) +	Relaxation (usually) +
Secretion		Inhibition (?)	Stimulation +++
<i>Gallbladder and Ducts</i>		Relaxation +	Contraction +
<i>Urinary Bladder</i>			
Detrusor	β	Relaxation (usually) +	Contraction +++
Trigone and sphincter	α	Contraction ++	Relaxation ++
<i>Adrenal Medulla</i>		—	Secretion of epinephrine and norepinephrine

Effector Mechanisms

The extrinsic control system, acting via autonomic nervous system and hormonal pathways, can alter cardiovascular system performance via several distinct effector mechanisms:

Arteriolar Resistance

Under normal conditions the vascular smooth muscle in arterioles has a resting tension or “tone” established by a basal level of sympathetic stimulation. Increases in sympathetic activity lead to increased tone in the vascular smooth muscle and increases in peripheral resistance. Figure 20 illustrates the flow-pressure curves of the vascular bed of rabbit ears. Increasing sympathetic tone

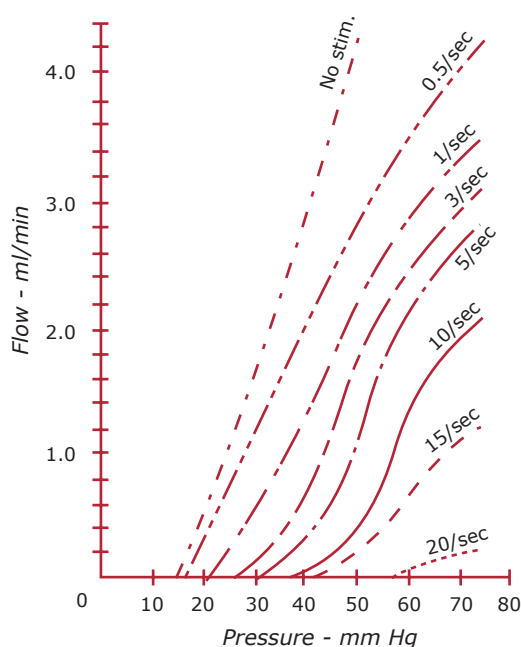

Figure 20: Flow-pressure curves of the vascular bed of the ears of rabbits, with increasing vasomotor tone produced by stimulating the sympathetic nerves (superior cervical ganglion) at the frequencies shown. Note the nonlinearity and the increasing intercept on the pressure axis (critical closing pressure). (From Girling: *Am. J. Physiol.* 170:131, 1952, reproduced in Burton, p. 73.)

Figure by MIT OCW. After Girling. *Am. J. Physiol.* 170: 131 (1952); reproduced in Burton, p.73.

causes increases in resistance, and also increases in the pressure required to open the arteries (the critical closing pressure). Figure 21 illustrates in diagrammatic fashion that skin arterioles show the most dramatic increase in resistance. Vascular beds in the brain show little response to sympathetic tone. (They respond primarily to pCO₂ levels.) Muscle vascular beds will dilate when sympathetic tone decreases, and there is some evidence to suggest that some sympathetic fibers to muscle may actually secrete acetylcholine and have a vasodilatory effect that might be preparatory for “fight or flight”. Vascular smooth muscle is not innervated by the parasympathetic nervous system except in genital erectile tissue (which receives parasympathetic vasodilator nerves).

Hormonal influences (see Figure 22): The adrenal medulla secretes mainly epinephrine (E), but some norepinephrine (NE). NE exerts pure vasoconstrictor effects via α receptors. E acts via both α and β receptors. In skeletal muscle, cardiac muscle and liver, the β (vasodilator) receptors predominate; while skin, kidney and GI tract have more α (vasoconstrictor) receptors.

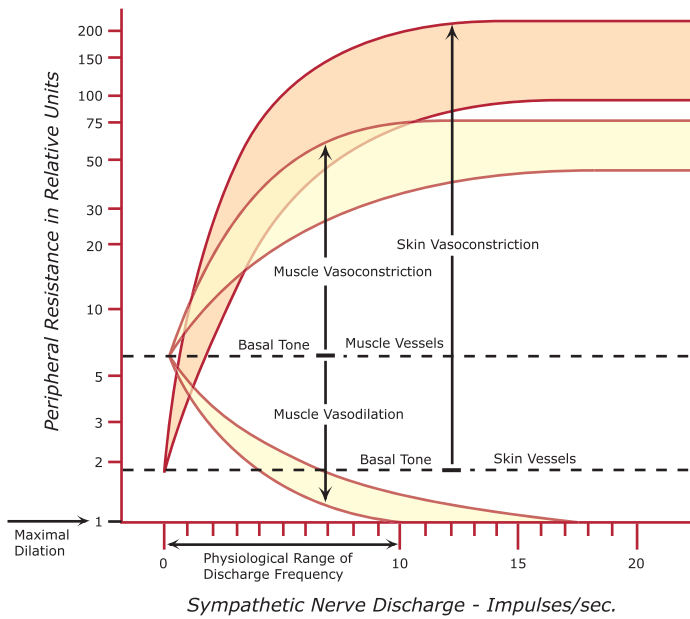

Figure 21: Diagrammatic representation of basal tone and the range of response of the resistance vessels in muscle and skin to sympathetic nerve stimulation. Peripheral resistance plotted on a logarithmic scale. (Redrawn from Celander, O., and Folkow, B.: *Acta Physiol. Scand.* 29:241, 1953.)

Figure by MIT OCW. After Celander, O., and B. Folkow. *Acta Physiol. Scand.* 29: 241(1953).

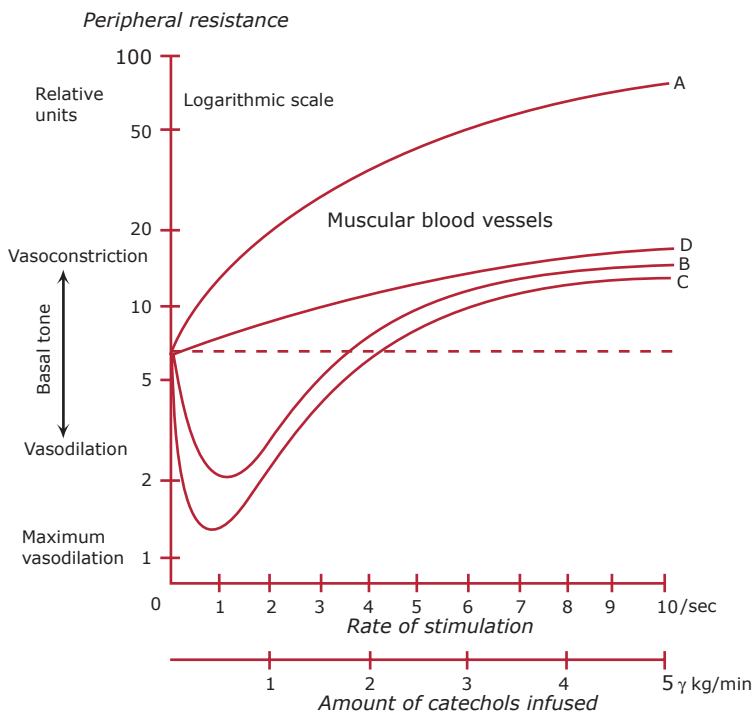

Figure 22: Blood vessels of muscle. A, electrical stimulation of sympathetic vasoconstrictor nerves to muscle. B, to both adrenal glands. C, l-adrenaline. D, l-noradrenaline. Note the dilation effect of adrenaline at low concentrations, absent for noradrenaline. (From Celander [1].)

Figure by MIT OCW. After Celander.

Vascular Zero-Pressure Filling Volume

Sympathetic stimulation constricts venous beds, thus decreasing the zero-pressure filling volume, decreasing stored blood volume and increasing circulating blood volume. **Hence, P_{ms} increases.** Constriction of venous capacitance vessels has rather little effect on the incremental capacitance (C_v in our model), but rather changes V_{V_0} , the zero-pressure filling volume. Thus, the slope of the venous pressure-volume curve does not change significantly with sympathetic stimulation, but rather its volume intercept (see Figure 23). Figure 24 shows effect of sympathetic stimulation on

both blood into a cat's hindquarters (reflecting a change in resistance), and change in tissue volume. The decrease in volume is due to a decrease in the venous zero-pressure filling volume and

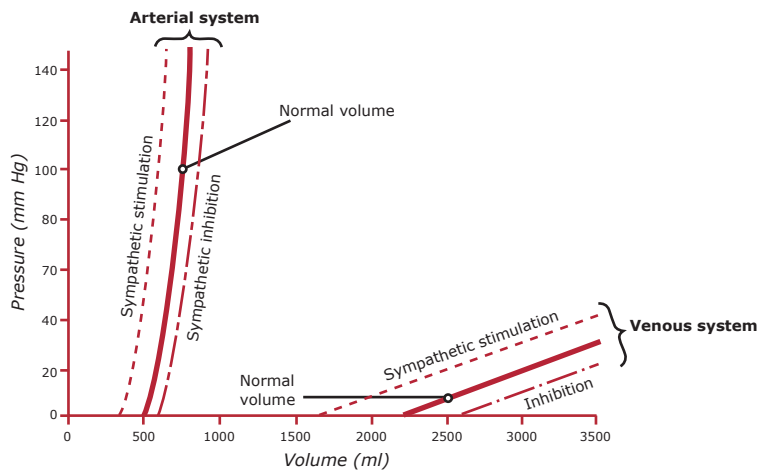

Figure 23: Volume-pressure curves of the systemic arterial and venous systems, showing also the effects of sympathetic stimulation and sympathetic inhibition. (From Guyton, A. C.: *Human Physiology and Mechanics of Disease*, 3rd ed. Philadelphia, W. B. Saunders Co., 1982.)

Figure by MIT OCW. After Guyton, A. in *Human Physiology and Mechanics of Disease*. 3rd ed. Philadelphia: W.B. Saunders, 1982.

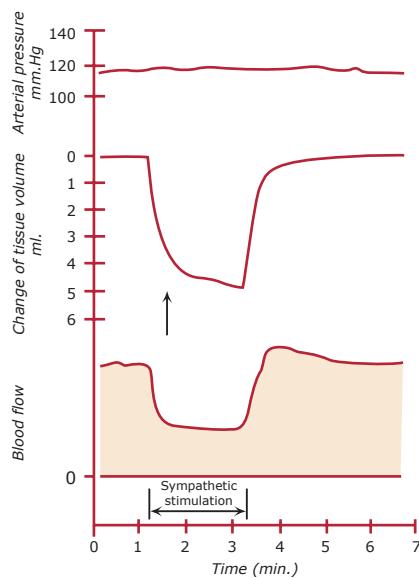

Figure 24: Effect of sympathetic nerve stimulation (2 impulses/sec) on blood flow and tissue volume in the hindquarters of the cat. The arrow denotes the change in slope of the tissue volume curve where the volume decrease due to emptying of capacitance vessels ceases and loss of extravascular fluid becomes evident. (Redrawn from Mellander, S.: *Acta Physiol. Scand.* 50[supp 176]:1-86, 1960.)

Figure by MIT OCW. After Mellander, S. *Acta Physiol. Scand.* 50[supp176]: 1-86, 1960.

also to the reabsorption of the interstitial fluid due to a decrease in capillary hydrostatic pressure. Figure 25 shows the relative responses of capacitance and resistance vessels to sympathetic stimulation, showing that venoconstriction is more sensitive to sympathetic stimulation than arteriolar constriction. Figure 26 makes the point that venous beds in different parts of the body may respond differently to sympathetic stimulation. Splanchnic veins (in the abdominal cavity) respond dramatically to NE, the skin vessels respond strongly to temperature and emotion, and the veins in muscle beds are heavily influenced by muscle contraction. The effect of venoconstriction is demonstrated clearly in the venous return curves (see Figure 27). Sympathetic stimulation results in a major shift in P_{ms} , and a small change in the slope of the curves that reflects an increase in resistance. Hence, sympathetic stimulation acting on the peripheral circulation *increases cardiac output*.

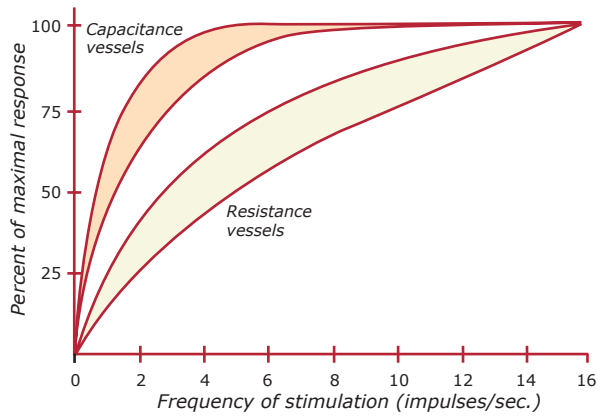

Figure 25: Comparison of the responses of capacitance and resistance vessels (skin and muscle) to sympathetic nerve stimulation. (Redrawn from Mellander, S.: *Acta Physiol. Scand.* 50[supp 176]:1-86, 1960.)

Figure by MIT OCW. After Mellander, S. *Acta Physiol. Scand.* 50[supp176]: 1-86, 1960.

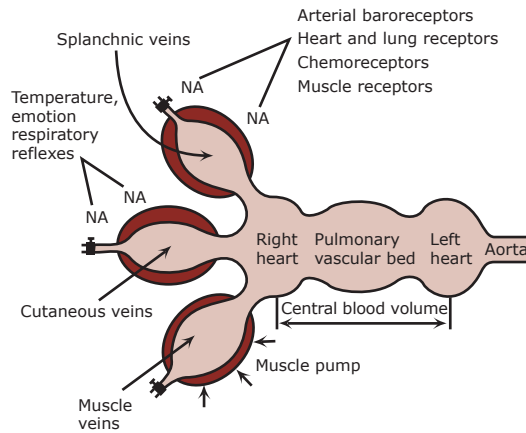

Figure 26: Venoconstriction in different vascular beds.

Figure by MIT OCW.

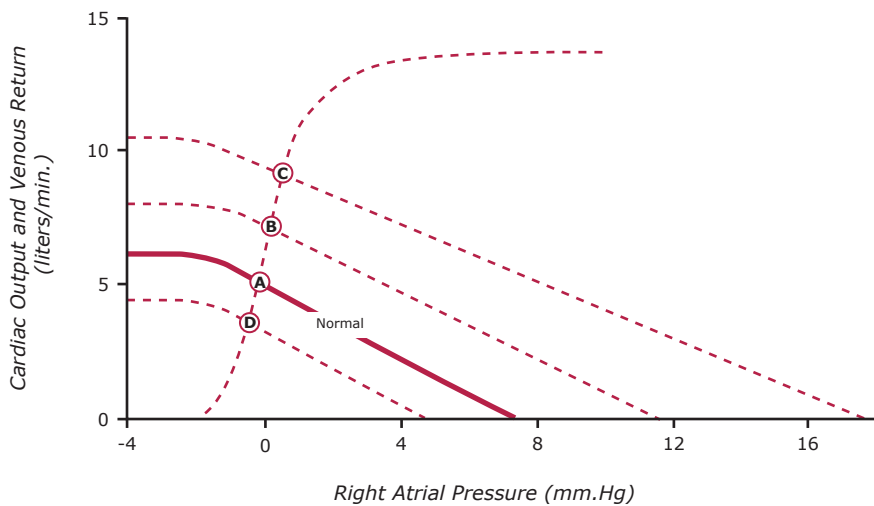

Figure 27: Effect on cardiac output of sympathetic stimulation of the peripheral circulation without stimulation of the heart, illustrating a very significant change in cardiac output even when the pumping ability of the heart was controlled very precisely.

Figure by MIT OCW. After Guyton (1973), Fig. 18-3.

Heart Rate

Heart rate is set by the rate of discharge of autorhythmic cells in the sinoatrial node. This region is richly innervated by both sympathetic and parasympathetic (vagal) fibers. The SA nodal cells are also responsive to circulating E (β receptors \rightarrow \uparrow HR). Heart rate is set by a balance between sympathetic and parasympathetic stimulation. (See Figure 28.) Intense vagal stimulation may even

temporarily stop the heart. The dynamics of sympathetic and parasympathetic control of heart rate are quite different. Vagal stimulation (parasympathetic) results in *immediate* changes in heart rate. Sympathetic acceleration of heart rate is much slower. (See Figure 29.)

If all other factors remain constant, the cardiac output curve increases with heart rate to about 120-140 beats/min. C.O. falls at higher rates due to decreased diastolic filling.

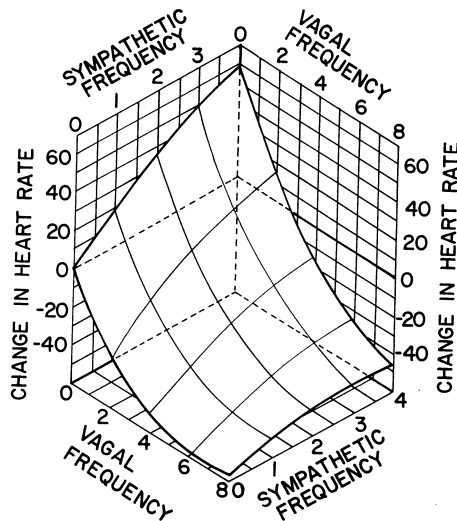

Figure 28: Heart rate changes as a function of vagal and sympathetic tone.

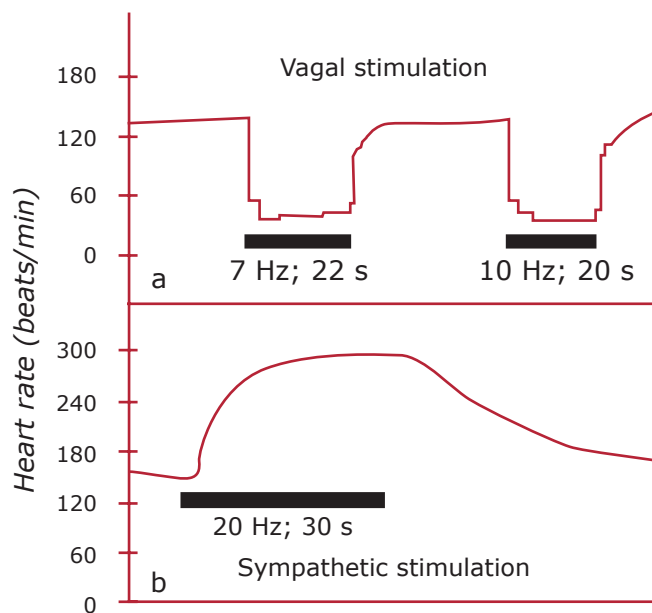

Figure 29: Changes in heart rate evoked by stimulation (horizontal bars) of the vagus (A) and sympathetic (B) nerves in an anesthetized dog. (Modified from Warner HR, Cox AJ: *Journal of Applied Physiology* 17:349, 1962.)

Figure by MIT OCW. After Warner, HR and A.J. Cox. *Journal of Applied Physiology* 17: 349(1962).

Cardiac Contractility

The inotropic state of the myocardium is modulated by autonomic and hormonal stimulation. Increased contractility results from sympathetic stimulation, and from circulating NE, E. Decreased contractility results from reducing normal sympathetic tone, or from parasympathetic stimulation. (See Figure 30.)

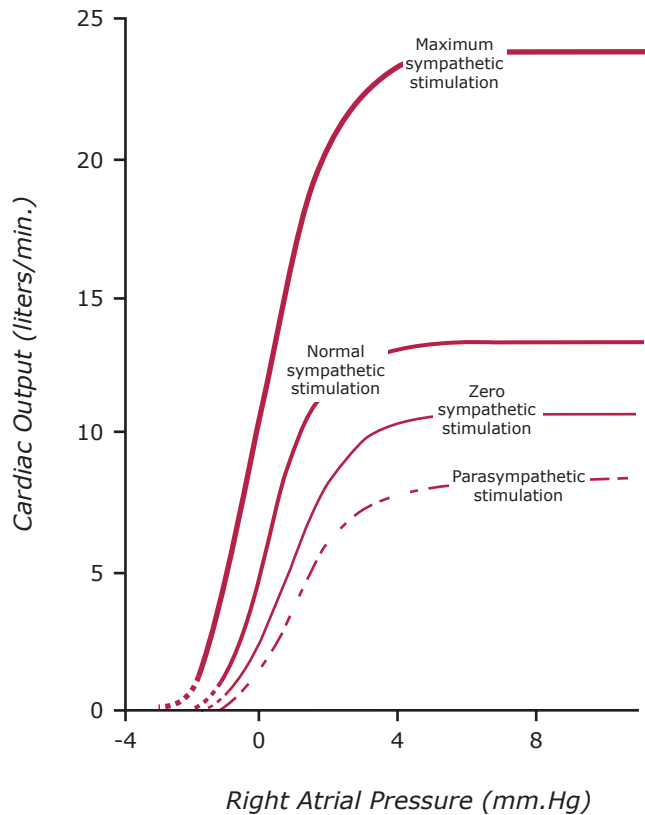

Figure 30: Changes in the cardiac output curve as a function of sympathetic stimulation.

Figure by MIT OCW. After Guyton (1973), Fig. 9-4.

Blood Volume

The first-order regulation of fluid balance depends primarily on the relation between urine output and renal arterial pressure. In an *isolated* kidney urinary output is a strong function of renal arterial pressure (Figure 31). In the intact organism it is a much stronger function due to neural and hormonal effects superimposed on strictly hydrostatic effects (Figure 32). Thus, as BP drops, sympathetic stimulation increases, constricting the afferent arterioles, causing a decrease in glomerular perfusion pressure. Also low BP results in renin liberation from juxtaglomerular apparatus which acts on α_2 -globulin in plasma to produce the decapeptide angiotensin I, which is converted in the lungs to the octapeptide angiotensin II which liberates aldosterone from the adrenal cortex. The aldosterone cause increased sodium and water conservation (decreased urine output). Finally, decreased blood volume causes secretion of anti-diuretic hormone which reduces urine output. Figure 33 shows the basic fluid balance control loop as proposed by Guyton (Ref. 4). Block 1 represents the renal function curve in the intact animal. $\frac{dE}{dt}(o)$ is the rate of fluid loss via urine. Block 2 subtracts output of urine $\frac{dE}{dt}(o)$ from net intake of extracellular fluid $\frac{dE}{dt}(i)$. Block 3 integrates $\frac{dE}{dt}$ to give extracellular fluid volume E. Block 4 determines blood volume (BV) as a function of extracellular fluid volume. The BV determines a mean systemic filling pressure MSP (block 5) which ultimately determines a venous return and cardiac output (blocks 6,7). The loop is closed by block 8 which states that arterial pressure is C.O. multiplied by total peripheral resistance (TPR).

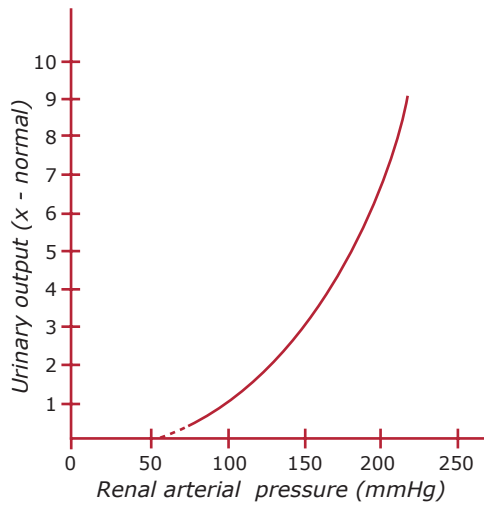

Figure by MIT OCW.

Figure 31: Effect of arterial pressure on the rate of urinary volume output. The curve of this figure is called a “renal function curve.” This curve is determined in the normal isolated kidney when the arterial pressure is changed through a range of values.

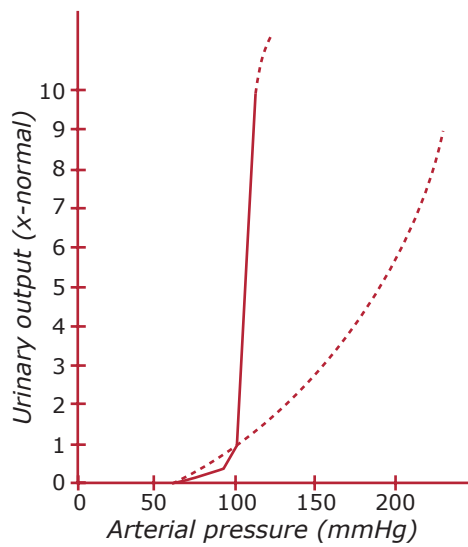

Figure by MIT OCW.

Figure 32: Comparison of the renal function curve as measured in the isolated kidney and that measured in an intact animal, showing in the intact animal an extremely steep slope for the relationship of urinary output to arterial pressure.

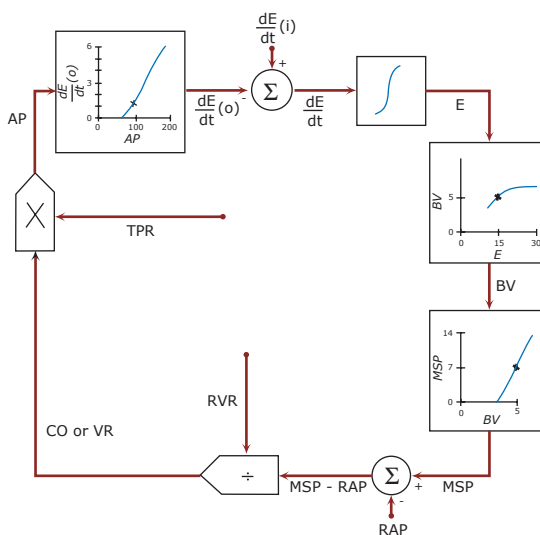

Figure by MIT OCW. After Guyton.

Figure 33: The basic fluid balance control loop, showing interrelationships of the major physical factors that play significant roles in control of extracellular fluid volume and blood volume.

Sensors or Receptors

The cardiovascular control system includes a number of sensors which monitor several relevant variables.

Local metabolic state

As discussed above local, metabolic state is sensed by precapillary sphincters. These sphincters respond directly to local factors, and hence are part of the intrinsic rather than extrinsic control system. Nevertheless it is appropriate to note that overall cardiovascular control does, in fact, measure the state of local perfusion and responds appropriately to it, particularly in skeletal and cardiac muscle.

Pressure Sensors

Baroreceptors play a very important role in the extrinsic control system, since they monitor central arterial pressure which is a controlled variable. The sensors are stretch receptors located in the carotid sinus and the aortic arch. (See Figure 34.) They respond to stretch of the arterial wall caused by changes in the transmural arterial pressure. Afferent nerves from the carotid sinus (sinus nerve) return to the medulla via the glossopharyngeal nerves (IX), and the “depressor nerve” carries afferent impulses from aortic arch receptors to the vagus (X) and hence back to the medulla. The rate of firing of the afferent fibers is related to both the mean arterial pressure, and also to the rate of the change of the pressure. (See Figures 35, 36.) The baroreceptors are the primary receptors for short-term, beat-by-beat control of the CV system.

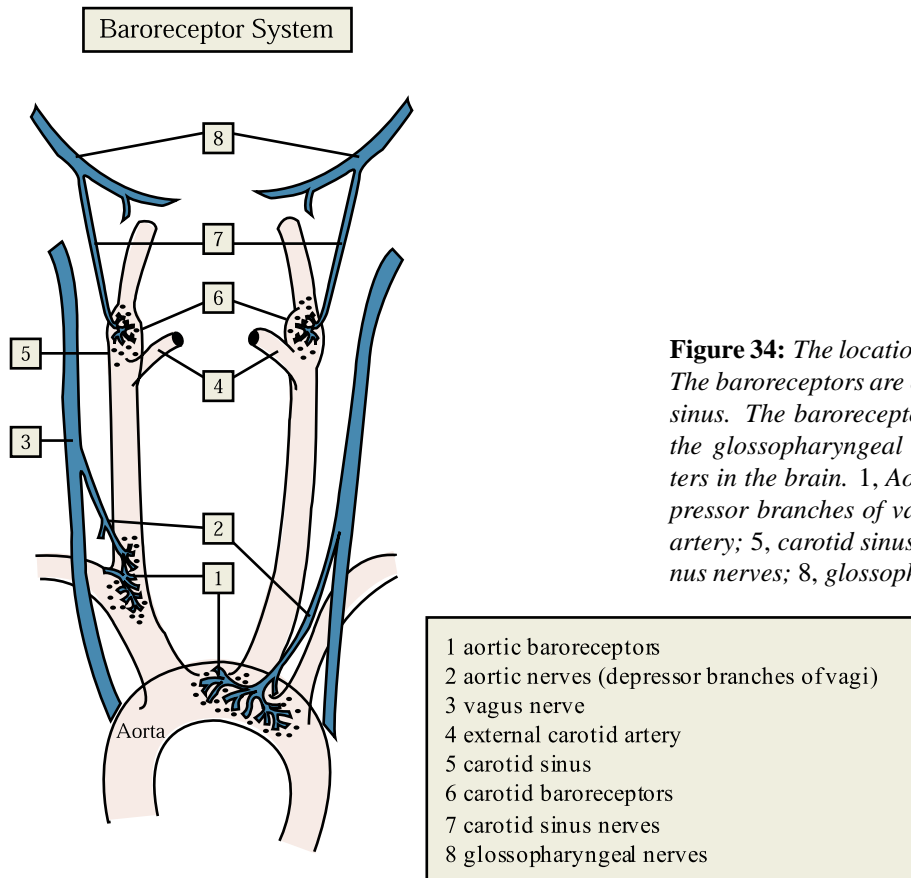

Figure 34: The location of baroreceptors and their innervation. The baroreceptors are on the outside curvature of the aorta and sinus. The baroreceptor system ultimately uses the vagus and the glossopharyngeal nerves to signal to the vasomotor centers in the brain. 1, Aortic baroreceptors; 2, aortic nerves (depressor branches of vagi); 3, vagus nerve; 4, external carotid artery; 5, carotid sinus; 6, carotid baroreceptors; 7, carotid sinus nerves; 8, glossopharyngeal nerves.

Figure by MIT OCW.

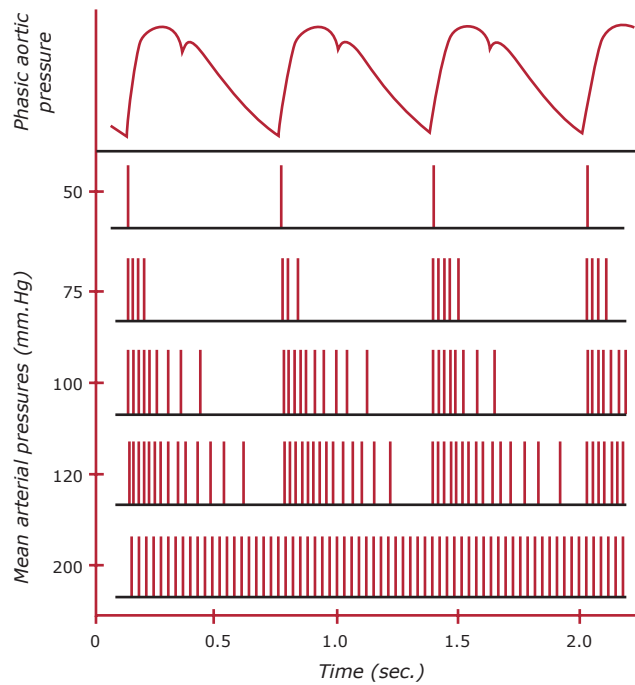

Figure by MIT OCW.

Figure 35: Relationship of phasic aortic blood pressure to the firing of a single afferent nerve fiber from the carotid sinus at different levels of mean arterial pressure.

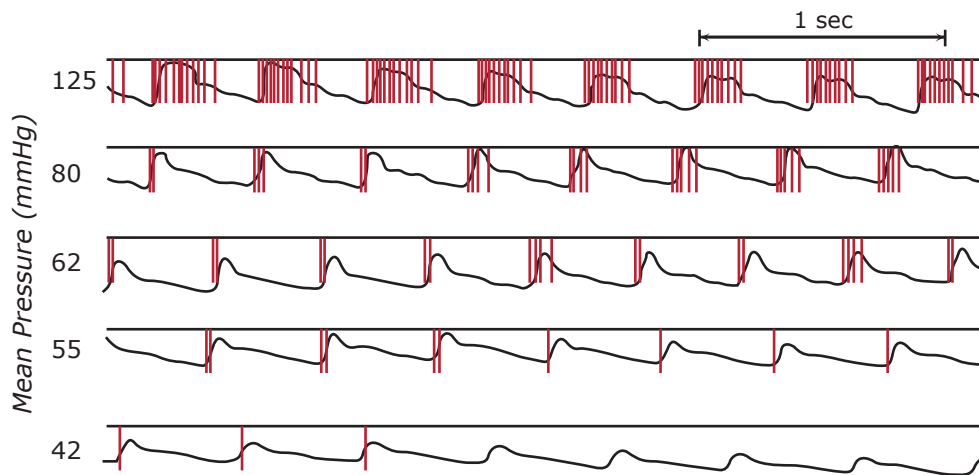

Figure by MIT OCW. After Neil.

Figure 36: Impulse activity in single fiber of left aortic nerve, and blood pressure recorded from left common carotid artery. Mean pressures in five records shown, beginning at top, are 125, 80, 62, 55, and 42 mmHg. (From Neil.)

Chemoreceptors

Arterial receptors that respond to changes in O_2 , CO_2 , and H^+ ion concentrations are found in specialized tissues near the aortic arch and carotid bifurcations. (See Figure 37.) Under normal conditions these sensors play very little role in circulatory regulation—and if blood gases are within normal range very few impulses are generated by these sensors. When blood gases

begin to deviate from normal the respiratory response is constantly controlled by chemoreceptor reflexes. These receptors act as an “emergency system” for the cardiovascular system in the presence of severe perturbation of blood gases. The average chemoreceptor output impulse frequency is a function of both pO_2 and pCO_2 , and is also modulated by blood flow through the sensor. (See Figure 38). The cardiovascular effects of carotid chemoreceptor stimulation are intense bradycardia, arteriolar vasoconstriction, and increased adrenal secretion of catecholamines. Cardiac output falls, but resistance increases such that arterial pressure rises. Interestingly, stimulation of the *aortic* chemoreceptors seems to cause reflex tachycardia. Why the different sensors result in opposite reactions is not clear.

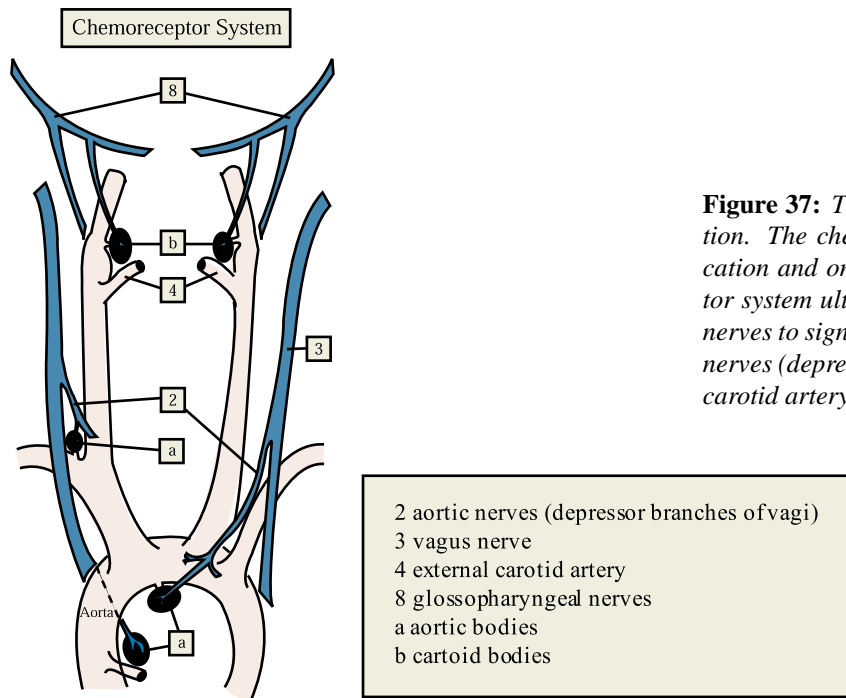

Figure 37: The location of chemoreceptors and their innervation. The chemoreceptors are in the angle of the sinus bifurcation and on the inside curve of the aorta. The chemoreceptor system ultimately uses the vagus and the glossopharyngeal nerves to signal to the respiratory centers in the brain. 2, aortic nerves (depressor branches of vagi); 3, vagus nerve; 4, external carotid artery; A, aortic bodies; B, carotid bodies.

Figure by MIT OCW.

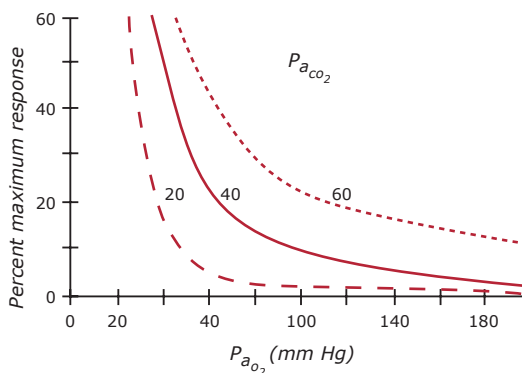

Figure 38: Average chemoreceptor impulse frequency recorded from multifiber preparation, expressed as percent of maximum response (ordinate), in relation to changes in arterial pO_2 and pCO_2 (abscissa). (From Korner.)

Figure by MIT OCW. After Korner.

The vasomotor center of the medulla apparently also has the ability to sense hypoxia or hypercapnia (increased pCO_2). If the effective perfusion pressure of the brainstem falls below 50 mmHg there is a tremendous sympathetic system response with maximum vasoconstriction in peripheral and renal beds, and cardiac stimulation. (This is the so-called “CNS ischemic response.”)

Volume Receptors

Regulation of blood volume is, of course, of key importance to the body. If a bolus of fluid is rapidly infused into an animal, urine output will quickly increase to restore intravascular volume within a few hours. The sensors involved in the “volume receptor reflex” actually do not measure volume directly, but rather respond to stretch or distension of walls of vessels or heart chambers. The most important receptors are stretch receptors located in the walls of the right and left atria. (See Figure 39.)

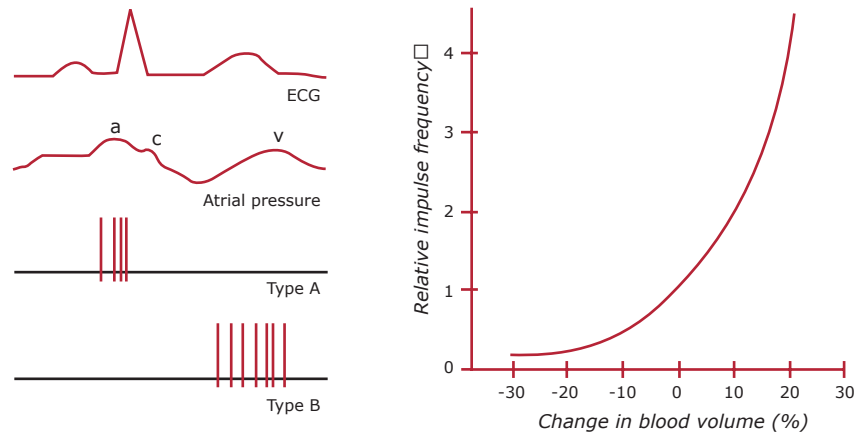

Figure by MIT OCW. Based on data of Gupta et al. and Paintal.

Figure 39: Atrial baroreceptor activity. Left: Relation between electrocardiogram (ECG), left atrial pressure, and impulses in afferent vagal fibers from type A and type B atrial receptors. Right: Relative frequency of impulses (ordinate) in afferent fiber from type B receptor when total blood volume was changed from its normal level. Change in atrial pressure in these experiments was approximately ± 5 cm H_2O for $\pm 20\%$ change in blood volume. (Based on data of Gupta et al. and Paintal.)

Stretch receptors of similar anatomy to those in the atria have been found in the ventricular walls, the pulmonary artery and the walls of the great veins of the thorax. Whether they play a role in the “volume receptor reflex” is not known. Impulses from volume receptors are carried to the vasomotor center in the medulla where several responses are elicited. In response to a *decrease* in volume receptor neural output the following occur:

1. Neural connections to the hypothalamus lead to increases in secretion rate of antidiuretic hormone (ADH), and in level of thirst. The result is decreased urine output and more drinking.
2. Sympathetic stimulation of the kidney is increased, decreasing rates of urine flow and sodium excretion. Also renin secretion increases, triggering a chain of reactions that result in fluid retention.
3. Increases in the sympathetic stimulation to pre- and postcapillary resistance vessels reduces capillary hydrostatic pressure thus resorbing interstitial fluid into the vascular space.

Sensors of Internal and External Environment

Although the baroreceptors and chemoreceptors are the key sensors in the regulation of the circulation, it is well known that a wide variety of situations exist in which signals from the external

environment or internal environment may alter cardiovascular function. “Deep pain” associated with visceral manipulation, distortion of joints, testicular trauma etc. leads to the dramatic somatic depressor response characterized by bradycardia, cold sweat, syncope, nausea, and weakness. Sensors of external temperatures exist in the skin and lead to reflex vasoconstriction. Similarly, internal body temperature is sensed by cells in the hypothalamic thermoregulatory center. We have already mentioned the ability of the medullary vasomotor center to detect and respond to ischemia of the CNS.

Finally, the cardiovascular system responds to stimuli originating in the external environment and interpreted at the cortical level. Thus, threats as perceived via sight, sound, smell, etc. will cause dramatic cardiovascular responses. Obviously, a comprehensive understanding of cortical autonomic mechanisms is still beyond our reach, but it is clear that these higher nervous centers act continuously with medullary centers in control of cardiovascular function.

Central Control Logic

All levels of the CNS from cortex to spinal cord contribute to control of the circulation. The most essential “control logic” is at the level of the medulla oblongata and lower pons. This region—the vasomotor center—is responsible for generation of tonic and reflex efferent impulses to all the effectors in the cardiovascular system. Higher centers in the brain influence the CV system via the medullary center—except for the sympathetic vasodilator pathways which originate in the motor cortex. In broad terms, the medullary center functions to convert a particular combination of afferent signals from sensors into an appropriate set of effector responses. In general, blood vessels are controlled via the degree of sympathetic tone, and the heart is controlled by the interplay of vagal and sympathetic outflow. (For more detail on the role of the CNS, refer to reference 2).

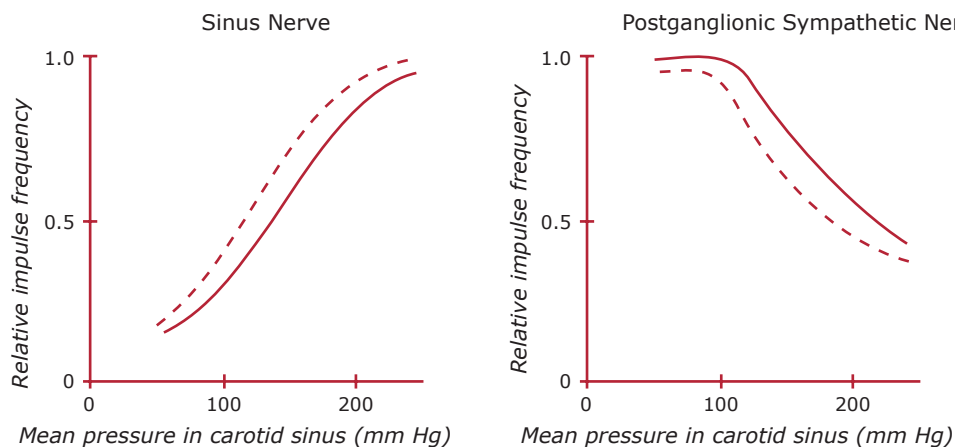

Figure by MIT OCW. Based on experimental observations by Spickler et al.

Figure 40: Impulse frequencies in carotid sinus nerve and in postganglionic sympathetic nerve as function of pressure in dog carotid sinus. Unbroken line represents response to constant pressures; broken line represents response to pulsations around indicated mean pressure as pressure is raised in sinus, there is increase in average frequency of afferent impulses from baroreceptors and decrease in frequency of efferent impulses in sympathetic vasoconstrictor nerve. (Based on experimental observations by Spickler et al.)

The Baroreceptor Reflex

Controlled variable: blood pressure

Sensor: Carotid sinus and aortic baroreceptors

Effectors: Peripheral resistance, capacitance, cardiac rate and contractility.

All of these responses work together to increase P_a toward the set point.

Measurements can be made of the open loop system by isolating and perfusing the carotid sinus, and recording the activity in the sinus nerve and in a post-ganglionic sympathetic nerve. The results are shown in Figure 40. Note the decrease in post-ganglionic sympathetic nerve activity which corresponds to an increase in carotid sinus perfusion pressure. This drop in sympathetic activity causes a drop in systemic arterial pressure as shown in Figure 41. Note that the rate of

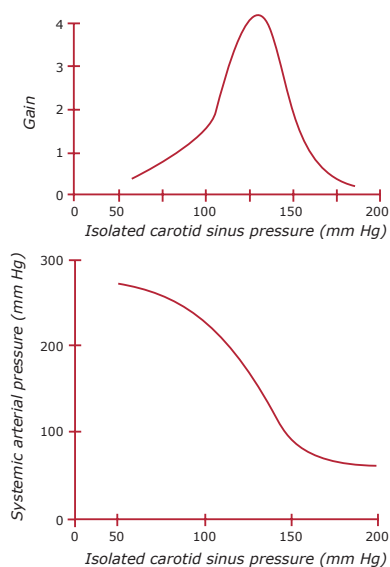

Figure 41: Characteristics of baroreceptor reflex when carotid sinuses have been isolated from rest of circulation, while their innervation remains intact (“open-loop” conditions). When pressure is raised in isolated sinuses, reflex responses in heart and blood vessels lead to fall in systemic arterial pressure (bottom). Change in arterial pressure for a given change in sinus pressure can be expressed quantitatively as “open-loop gain” (top). (Modified from Korner.)

Figure by MIT OCW. After Korner.

change of systemic pressure with respect to carotid sinus pressure $\frac{dP(\text{systemic})}{dP(\text{sinus})}$ loop gain of the system. Figure 41 shows this gain to be maximum in the physiologic range. Finally, an open loop experiment using the aortic arch receptor demonstrates the effect of a stepwise change in aortic pressure on heart rate. The abrupt increase in pressure caused a bradycardia. (Figure 42).

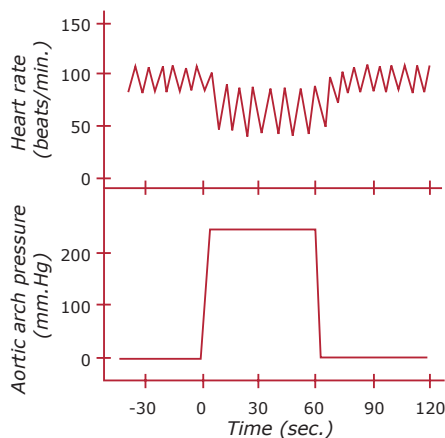

Figure 42: Effect of a stepwise pressure change in the isolated aortic arch on heart rate. When pressure is raised, the mean heart rate decreases and there is an increase in the magnitude of the rhythmic fluctuations of heart rate at the frequency of respiratory movements. (Redrawn from Levy, M. N., Ng, M. L., and Zieske, H.: *Circ. Res.* 19:930, 1966.)

Figure by MIT OCW. After Levy, Ng, and Zieske. *Circ Res* 19: 930, 1966.

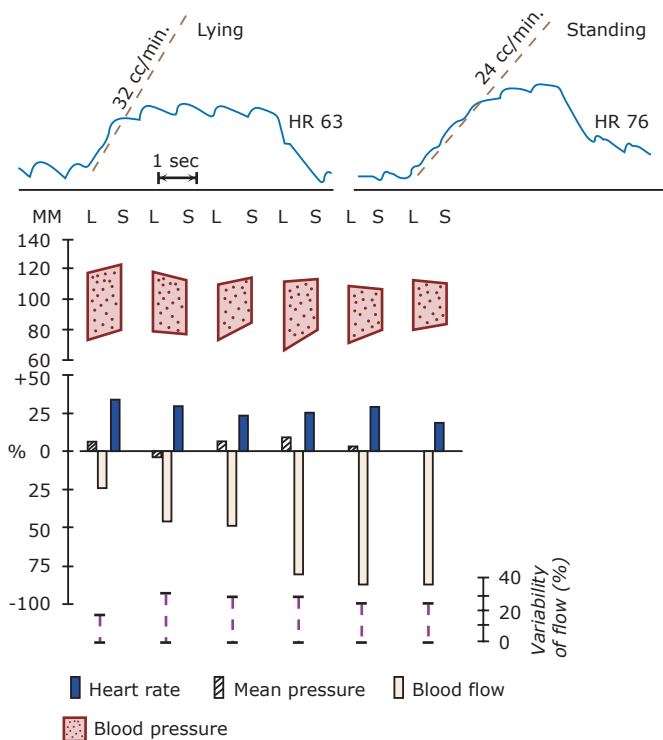

Figure 43: The response to change in posture from lying (L) to standing (S) in six normal subjects. The blood pressure changes very little, owing to the increase in heart rate and the increase in peripheral resistance, indicated by the decrease in finger blood flow (records of this by venous-occlusion plethysmograph are shown at top) and the narrowing of pulse pressure. (From Jeffers et al.)

Figure by MIT OCW. After Jeffers et al.

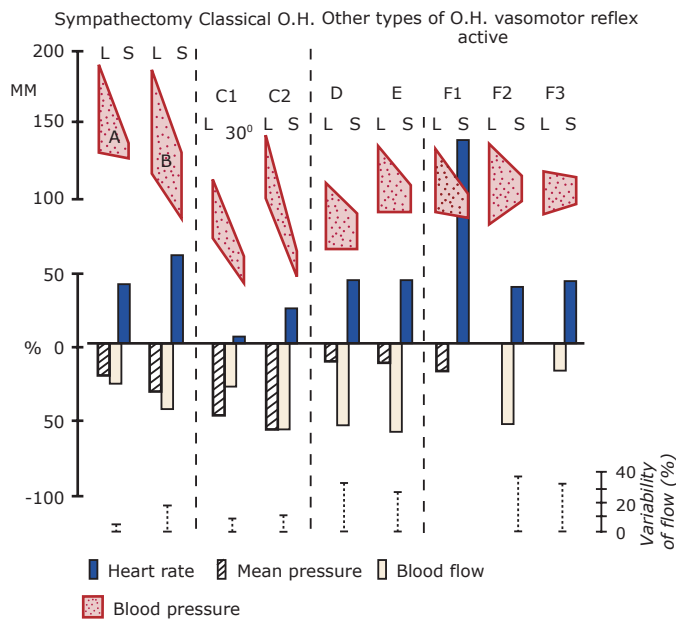

Figure 44: For different types of orthostatic hypotension, in sympathectomized patients (A and B) and in those with mechanical pooling of blood in the legs (D, E and F), the cardiac reflex effects are exaggerated, yet the blood pressure falls. In the classic type (C), the reflex is practically absent and the blood flow falls only in proportion to the fall of the blood pressure. **Bottom,** the per cent variability of flow (as the standard deviation of determinations made very 6 sec) also indicates the degree of activity of the sympathetic vasoconstrictor system. (from Jeffers et al.)

Figure by MIT OCW. After Jeffers et al.

The importance of the baroreceptor reflex is illustrated graphically by patients in whom the reflex is damaged or destroyed by disease. Figures 43 and 44 illustrate the response to postural change in normal and abnormal subjects. The measured variables include blood pressure, heart rate, and blood flow in a finger (a measure of peripheral vasoconstriction). Notice the drastic drop in blood pressure which occurs in some diseased patients upon standing.

Summary

We have briefly reviewed some of the high points of extrinsic cardiovascular control mechanisms. Obviously both extrinsic and intrinsic factors are involved in regulation, and the balance varies depending on the tissue involved. In brain and heart, for example, the intrinsic mechanisms are predominant. On the other hand, in the skin extrinsic control is dominant. In skeletal muscle the interaction and balance between extrinsic and intrinsic mechanisms can be clearly seen. In resting muscle, neural control is dominant. In anticipation of exercise, blood flow increases due to cholinergic sympathetic stimulation. After the onset of exercise local metabolic factors result in vasodilation.

References

1. Berne and Levy, Cardiovascular Physiology, ed. 5, Mosby, 1986, Chapters 8, 9, and 12.
2. Montcastle, V., Medical Physiology, Vol. II. Edition 13. Mosby, 1974, chapters 38, 39.
3. Burton, A.C. Physiology and Biophysics of the Circulation, Ed. 2, Yearbook Medical Pub. 1972, chapters 20, 21, 22, 23, and 24.
4. Guyton, Taylor and Granger, Circulatory Physiology II: Dynamics and Control of the Body Fluids, Saunders, 1975.