

Citation X: A Case Study



Copyright 2003

Amandine Denis
Patrick N. Freuler
Theresa Robinson
Matthieu Serrano
Mara E. Vatz

16.885 Aircraft Systems Engineering
Professor E. Murman
Professor J. Hansman

December 9th, 2003

Acknowledgements

The Citation X team would like to acknowledge the following people for their valuable contribution to this case study.

- Prof. Earll. Murman, MIT
- Prof. John. Hansman, MIT
- Dick Curtis, Cessna
- Paul Kalberer, Cessna
- Marc Morisson, Cessna

Table of Contents

Acknowledgements	ii
Table of Contents	iii
List of Tables	vi
List of Figures	vii
List of Acronyms	1
1. Introduction	2
1.1. Summary of Report.....	2
2. Aircraft Overview	4
2.1. General geometric properties.....	4
2.2. Innovative design features	5
2.3. Key Subsystems	5
2.4. Key performance figures.....	6
3. Program Overview	8
3.1. Timeline	8
3.2. Previous related aircraft	9
3.3. Market Context	12
3.4. Competition.....	14
4. Value Proposition.....	18
4.1. Value expectations of stakeholders.....	18
4.2. Stakeholders.....	19
4.3. Value Identification	19
4.3.1. Customers/ Acquirers.....	19
4.3.2. End users.....	20
4.3.3. Shareholders.....	20
4.3.4. Employees.....	21
4.3.5. Unions	21
4.3.6. Suppliers	21
4.3.7. Partners	22
4.3.8. Society.....	22

4.4. Value Proposition.....	22
5. Design process	24
5.1. Value delivery process.....	24
5.2. High-level requirements.....	25
5.3. Design goals.....	25
5.4. Key design decisions.....	26
5.5. Requirements flowdown	27
5.5.1. Need for subsystems	27
5.5.2. Subsystems requirement flow down	28
6. Detailed vehicle description.....	29
6.1. Performance	29
6.1.1. Operating Limitations	29
6.1.2. Take-off and Climb.....	35
6.1.3. Cruise	37
6.1.4. Approach and Landing.....	39
6.2. Stability & Control.....	40
6.2.1. Longitudinal Stability	40
6.2.2. Directional Stability	40
6.3. Subsystems.....	40
6.3.1. Airframe.....	41
6.3.2. Engines.....	45
6.3.3. Fuel system	49
6.3.4. Avionics	51
6.3.5. Landing Gear	54
6.3.6. Electrical System	57
6.3.7. Pneumatic System.....	60
6.3.8. Environmental system.....	61
6.3.9. Ice protection System.....	64
6.3.10. Oxygen System	65
6.3.11. Angle of Attack System	66
6.3.12. Controls.....	67

6.3.13. Hydraulic System.....	77
6.4. Subsystem interfaces.....	80
6.4.1. Wing/Fuselage	81
6.4.2. Hydraulics/Structure	81
6.5. Weight breakdown.....	83
7. Program Management Approach	84
7.1. Organization at Cessna	84
7.2. Total Quality Management	86
7.3. Human-related practices	89
7.4. Systems Engineering practices	90
7.5. Comparison to Lean Enterprise Model	94
7.6. Lean Manufacturing.....	94
8. Lifecycle considerations	97
8.1. Design for manufacturing, maintenance.....	97
8.2. Prototyping.....	97
8.3. Verification, validation, certification.....	98
8.4. Product support	99
8.5. Ownership costs.....	99
8.5.1. Full ownership	99
8.5.2. Half-Ownership through Netjets.....	100
8.6. New 2002 version	101
9. Operating experience	102
9.1. Operation Experience Summary	102
9.2. Identified Advantages and Drawbacks	102
9.3. Accidents and Incidents	103
9.4. Anomalies/Airworthiness directives	105
10. Conclusions.....	107
11. References.....	110

List of Tables

Table 1: Citation X Basic Geometry.....	4
Table 2: Performance Data for the Citation X (from [1]).....	7
Table 3: Citation X Production.....	9
Table 4: The Citation Family before the introduction of the Citation X.....	10
Table 5: Business Jet Market Sectors [5].....	13
Table 6: Comparison of the Citation X with a few competitors [11].....	17
Table 7: Citation X stakeholders.....	19
Table 8: Maximum Certified Weight Limitations.....	29
Table 9: V-n envelope limits.....	33
Table 10: In Flight Load Factors.....	34
Table 11: Take-Off Performance with 15° Flap Deflection.....	36
Table 12: Time to Climb Profile.....	37
Table 13: Fuel Consumption during Cruise Conditions.....	38
Table 14: Full Flap LandingPerformance [17], [32].....	39
Table 15: Subsystem Interfaces.....	82
Table 16: Weight Breakdown.....	83
Table 17: Changes in a company’s philosophy introduced by TQM [27].....	88
Table 18: Comparison of Cessna’s practices to the Lean Enterprise Model [34].....	94
Table 19: Performance Metrics.....	107
Table 20: Key Subsystems.....	107

List of Figures

Figure 1: Citation X three-view (from [1]).....	4
Figure 2: Citation X Cockpit (from [3])	6
Figure 3: Timeline of the Citation X program	8
Figure 4: CitationJet, Citation S/II, Citation III Citation Ultra, Citation VII ([1], [4]) ...	10
Figure 5: The Citation family in 1992 [1].....	11
Figure 6: Citation family in 2003[1].....	12
Figure 7: Range and high-speed cruise capabilities for jets offered by Netjets [35].....	15
Figure 8: Phases of Value Creation	18
Figure 9: Value Identification and Value Proposition	23
Figure 10: Value Delivery and Requirement Flow Down	24
Figure 11: Center of Gravity Limits	30
Figure 12: Center of Gravity Limits (2).....	31
Figure 13: Design Speed Envelope.....	32
Figure 14: V-n Diagram [31]	33
Figure 15: Maximum Maneuvering Speeds.....	34
Figure 16: Stall Speeds for Different Flap Deflections	35
Figure 17: Take Off Flight Path Profile.....	36
Figure 18: Payload Range Diagram.....	38
Figure 19: Fuselage Sections	41
Figure 20: Pitot and Static Ports	42
Figure 21: Typical Cabin Arrangement, from [20].....	43
Figure 22: AE3007C Engine.....	45
Figure 23: Thrust Reverser Operation	46
Figure 24: Oil System	48
Figure 25: Fuel System Schematic	50
Figure 26: Honeywell Primus System Logic	52
Figure 27: Landing Gear Schematic	54
Figure 28: Brake System Schematic	55
Figure 29: Nose Wheel Steering Schematic	56

Figure 30: Cross-Feed Bus Electrical System	58
Figure 31: Split-Bus Electrical System.....	59
Figure 32: Emergency Bus Items (Split-Bus System)	60
Figure 33: Pneumatic System Schematic.....	61
Figure 34: Air-Conditioning System Schematic.....	62
Figure 35: Pressurization System Components	63
Figure 36: Automatic Pressurization Schedule.....	64
Figure 37: Oxygen System.....	66
Figure 38: Control Surfaces	67
Figure 40: Ailerons and Roll Spoilers	71
Figure 41: Upper and Lower Rudder Systems.....	72
Figure 42: Lower Rudder Yaw Damper System.....	73
Figure 43: Upper Rudder Yaw Stability Augmentation System	74
Figure 44: Flap System Schematic	75
Figure 45: Slat System Schematic	77
Figure 46: Schematic of Hydraulic Subsystem.....	78
Figure 47: Power Transfer Unit	79
Figure 48: Organizational Chart at Cessna [32]	84

List of Acronyms

ACO	Aircraft Certification Offices
AD	Airworthiness Directive
APU	Auxiliary Power Unit
CAC	Customer Advisory Council
CAD	Computer Aided Design
CATIA	Computer Aided Three Dimensional Interactive Application
CFD	Computational Fluid Dynamics
EICAS	Engine Indicating and Crew Alert System
FAA	Federal Aviation Administration
FADEC	Full Authority Digital Engine Controller
FAR	Federal Aviation Regulation
GPS	Global Positioning Satellite
IAM&AW	International Association of Machinists and Aerospace Workers
IDT	Integrated Design Team
JAA	Joint Aviation Authority
LCD	Liquid Crystal Display
NBAA	National Business Aviation Association
PAC	Pressurization Air Conditioning
PCU	Power Control Unit
PSI	pounds per square inch
RAT	Ram Air Temperature
TQM	Total Quality Management
VHF	Very High Frequency
V_1	Takeoff decision speed
V_2	Take-off safety speed
V_{App}	Approach speed with landing gear up
V_R	Rotation speed
V_{Ref}	Approach speed with landing gear deployed; roughly $1.3V_{Stall}$
V_{Stall}	Stall speed

1. Introduction

This case study focuses on the Cessna Citation X aircraft system. The goals of the study are to explore the circumstances surrounding the development of a private business jet, to understand the key design decisions, and to extract lessons about aircraft design in general and aircraft systems engineering in particular.

The Citation X is the fastest business jet on the market, offering a valuable service to individuals and large companies through private ownership, and to smaller companies through charter or fractional ownership. Flying on a private business jet such as the Citation X, as opposed to commercial jets, gives companies more control over their travel times, and eliminates the frustrations of crowded airports, onerous security check points and commercial scheduling. The development of such an aircraft must respond directly to consumer demands, and offer clear advantages over the competitors. A case study of the Citation X, therefore, must look carefully at the consumer and market requirements, as well as the technical design choices that made it a more valuable commodity to its acquirers than competing aircraft.

The study addresses the social and economic contexts of the late 1980s and early 1990s, during which the idea and design of the Citation X were conceived. In turn, these circumstances were responsible for many of the technical design considerations of the aircraft, which are also thoroughly explored in this document.

1.1. Summary of Report

The study begins with an overview of the aircraft, with attention given to the general design of the plane, the design innovations, and the performance features of its systems and subsystems. A program overview follows, which lays out the timeline of the aircraft development, the technical and market contexts of the early days of the aircraft development, and brief descriptions of the competing aircraft of the time. The next section is a broad overview of the value propositions for the various groups involved with the development of the aircraft, such as the customers, employees, and shareholders.

The technical design details of the aircraft—with in-depth descriptions of all of its subsystems—make up the middle of the report. The requirements and expectations of the

customer and end user (who, for a business jet are often one in the same) are addressed, and the correlations between these expectations and the resulting design decisions are shown.

The latter part of the report steps back from the technical details and focuses on the long term factors of lifecycle considerations and operating expenses, leading to a conclusion that discusses the effectiveness and overall success of the Citation X program.

2. Aircraft Overview

The Cessna Citation X is a medium-sized business jet airplane designed to fly at high subsonic speeds. It is the fastest business jet available, and the second fastest civil airplane that has ever flown, after the Concorde.

2.1. General geometric properties

The Citation X is operated by two crew and carries from eight to twelve passengers. Table 1 summarizes the Citation X's basic geometric parameters and Figure 1 shows a three-view.

Wingspan	63.6 ft
Length	72.3 ft
Height	19.0 ft
Aspect Ratio	7.8
Wing Area	527 ft ²
Tailplane Span	26 ft
Dihedral	2°
Wing Sweep	37°

Table 1: Citation X Basic Geometry

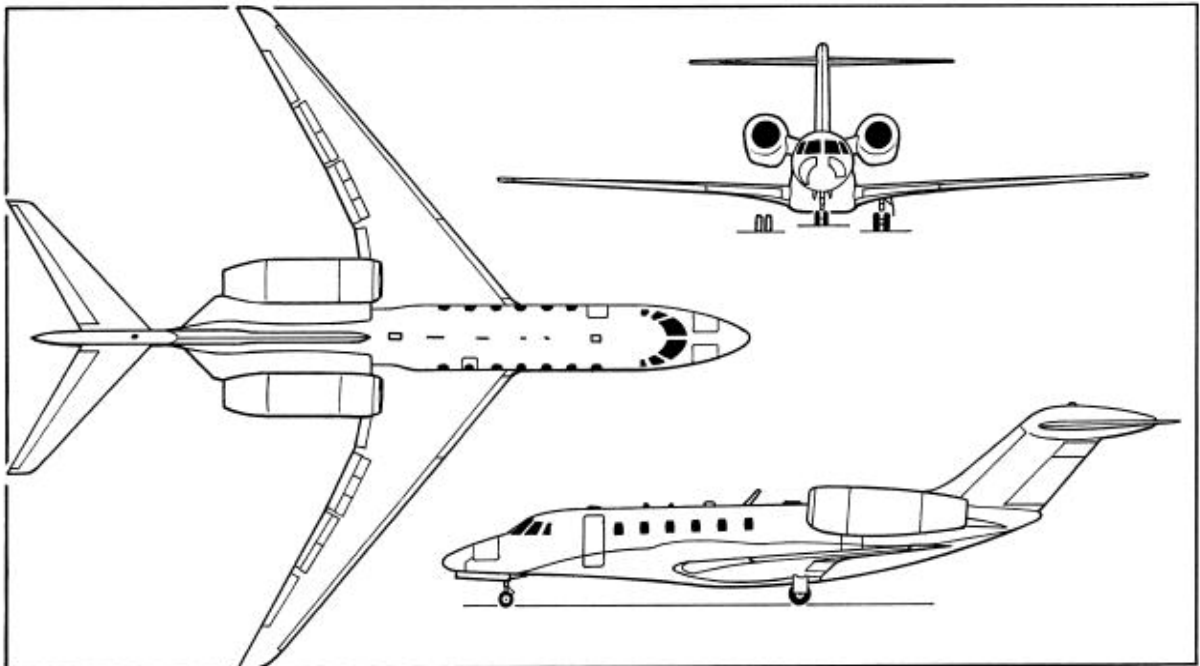

Figure 1: Citation X three-view (from [1])

2.2. Innovative design features

A number of innovative design features are apparent in Figure 1. One attribute that is often first noticed is the large diameter of the engine intakes. This feature, related to the high bypass ratio turbofan, reduces the noise from the engines and improves fuel efficiency. Another obvious characteristic is the highly swept wing, in order to increase the critical Mach number and therefore the top speed. The Citation X has 37 degrees of sweepback at the quarter chord, more than any other business jet and, among civil aircraft, second only to the Boeing 747's 37.5 degrees [2]. The horizontal and vertical stabilizers are also highly swept and are arranged in a T-tail configuration.

2.3. Key Subsystems

The subsystems of the aircraft are discussed in detail in section 6.3. Here the major characteristics of a few subsystems are outlined.

Airframe

A significant amount of effort throughout the design process was directed towards reducing the Citation X's total drag [3]. The resulting design includes an area-ruled fuselage for efficient transonic flight, and the aforementioned highly swept wing. Unlike those on previous Citation aircraft, the Citation X's wing is slung below the fuselage rather than passing through it [3]. This allows increased volume in the fuselage, a one-piece wing, and simplified wing-fuselage connections.

Engines

The Citation X is powered by two Rolls-Royce/Allison AE3007C1 turbofan engines, each with 6700 lbs of thrust, pod-mounted on the sides of the rear fuselage [1]. It is the first Cessna aircraft to be powered by a Rolls-Royce engine. The engine has solid titanium blades and a three-stage low-pressure turbine. The engine's fan has a 5 to 1 bypass ratio for improved fuel efficiency and low acoustic signature.

Powered Controls

Another first for Cessna is the inclusion of powered controls in the Citation X. The controls are powered by dual-hydraulic systems for redundancy. There are two elevators and the tailplane is all-moving for trim. The rudder is in two pieces: the lower

portion is hydraulically-powered and the upper portion is electrically-powered. Each wing has five spoiler panels, to be used both for roll control (in addition to the ailerons) and as speed brakes [1]. One of the major challenges of the Citation X design was finding enough space in the wing to run all the necessary hydraulic lines. As Paul Kalberer [3] explained, the Citation X needs just as many hydraulic pumps and actuators as a Boeing aircraft, but has much less space inside the wings.

Avionics

Honeywell provides the avionics system. The Honeywell Primus 2000 flight director system, depicted in Figure 2, is composed of five 7"x8" LCD screens. Dual flight management systems with GPS are standard.



Figure 2: Citation X Cockpit (from [3])

2.4. Key performance figures

Cessna advertises the Citation X as the fastest business aircraft available. It has a top speed of Mach 0.92, which at its normal flight altitude of 43000 feet is about 510 knots [3]. Since the retirement of the Concorde, no civil aircraft flies at a higher Mach number [2]. The Citation X has a range of about 3300 nautical miles, although this requires less than full payload (only one or two passengers) and a cruise Mach number of 0.82 [1]. It can easily travel between any two points in the continental United States, such as New York to Los Angeles (2139 nm). The Citation X can only perform a limited

number of transatlantic routes, such as New York - Paris (3159 nm), and is incapable of transpacific flights. The range decreases as the Mach number increases beyond 0.82, meaning customers are forced to choose between speed and range. Table 2 is a summary of some performance figures. The Citation X takes off in 5140 feet and lands in 3400 feet [1]. It has good fuel consumption, burning the same amount of fuel at Mach 0.9 that its competitors burn at Mach 0.8 [2], due to its efficient engines and low-drag configuration. Another key accomplishment is the 70-knot buffet margin (that is, the difference in speed between the stall buffet and the high-speed buffet). Many transonic airplanes at high altitudes have the stall buffet speed only 5 knots below the high-speed buffet. The Citation Xs wide margin allows for steep turns at high altitudes, which can be useful in emergency maneuvering. The wide margin also means that the speed does not have to be maintained at a precise value for safe operation of the airplane.

Weight empty (typically equipped)	21,600 lb
Max fuel weight	12,931 lb
Max T-O weight	36,100 lb
Max ramp weight	36,400 lb
Max landing weight	31,800 lb
Max zero-fuel weight	24,400 lb
Max wing loading	68.50 lb/sq ft
Max power loading	2.67 lb/lb st
Max operating Mach No. (MMO)	0.92
S/L to FL800	270 kt
FL800 to FL306	350 kt
Max cruising Mach Number, mid-cruise weight at FL370	0.91
Max cruising speed at FL350	525 kt
Max rate of climb at S/L	3,650 ft/min
Max certified altitude	51,000 ft
T-O balanced field length (FAR Pt 25)	5,140 ft
FAR Part 25 landing field length	3,400 ft
IFR range with two crew, M0.82	3,216 n miles

Table 2: Performance Data for the Citation X (from [1])

3. Program Overview

3.1. Timeline

The development of the Citation X was first announced at the NBAA Convention in New Orleans in October 1990.

Figure 3 shows some milestones in the evolution of the aircraft.

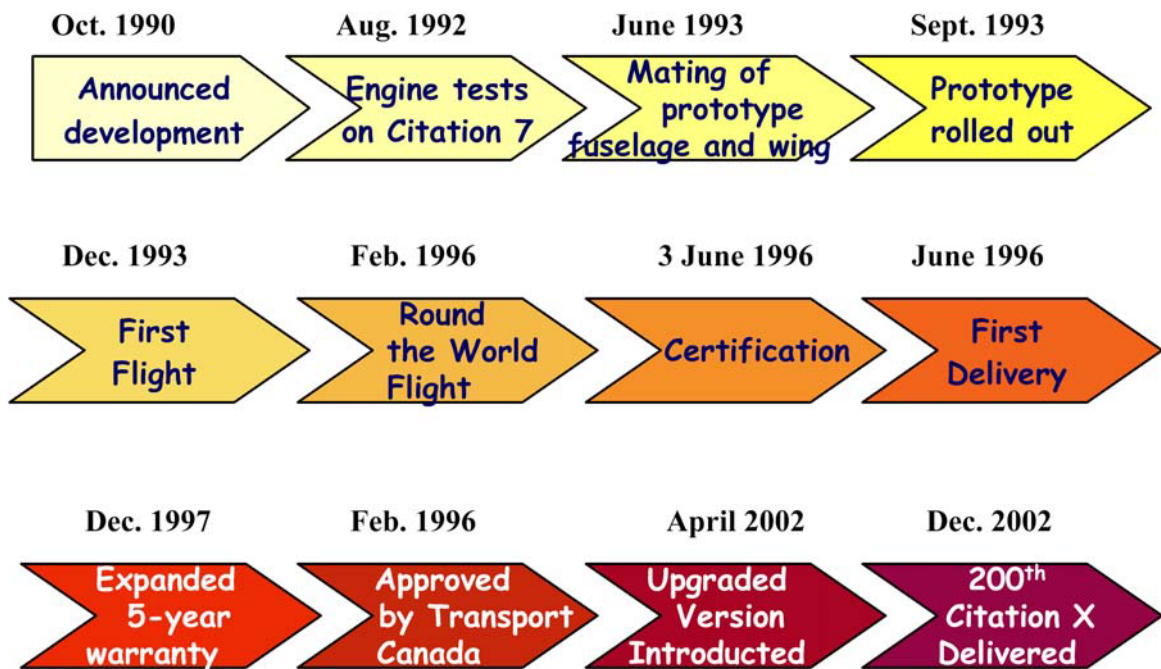

Figure 3: Timeline of the Citation X program

Originally scheduled for August 1995, the certification of the Cessna Citation X was delayed several times. First, failure of the airframe and engine to meet FAA requirements caused the planned certification date to be postponed to late November 1995. The main reasons for the delays were troubles integrating the avionics and the engine to the aircraft, engines flaming out at high altitude and low speed (airflow was insufficient at high angles of attack because of the interference of the wing), the engines not meeting the bird strike criteria and directional stability challenges [3]. Each of these challenges will be discussed in Chapter 6. Efforts to increase the maximum take-off weight of the Citation X by about 800 pounds led to another delay in the FAA certification schedule – this time to April 1996. These changes were aimed at permitting

a full-fuel payload of 1,400 pounds (seven passengers) but Cessna had difficulty achieving a balance between reducing Citation X cabin noise and minimizing the extra weight of sound-dampening materials. The certification – FAA FAR Part 25, Amendment 74, Certification 3 – was finally achieved on June 3, 1996.

The first Citation X was delivered in June 1996 to golfer and long-time Cessna customer Arnold Palmer. Once in use, the Citation X continued to set speed records. Arnold Palmer set one of them in September of 1997: 473 knots on a 5000 km closed course. In February 1997, the Citation X design team was awarded the National Aeronautic Association's Robert J. Collier Trophy. The Citation X was approved by Transport Canada on May 22, 1998 and by the JAA in 1999.

In October 2000, Cessna announced an upgrade for all Citation Xs to be delivered after January 1, 2002. The main characteristics of this upgraded version are a 5% increase in thrust, a 400lb increase in maximum take-off weight and improved Honeywell avionics. It is described in more detail in section 8.6. The production is summarized in Table 3.

Year	1996	1997	1998	1999	2000	2001	2002	2003*	2004*	Total**
Production	7	28	30	36	37	34	31	10	12	203

* Expected production [3]

** Total production at the end of 2002

Table 3: Citation X Production

The 100th delivery was achieved in December 1999 and the 200th delivery in December 2002. At the end of 2002, 203 Citation Xs had been produced. The first 172 Citation Xs are the original model and the more recent ones are the upgraded version of the aircraft.

3.2. Previous related aircraft

The Citation family consists of several aircraft, each designed to meet the needs of consumers in a different market sector. All Citations are small to midsize business jets. At the time of the introduction of the X, the Cessna Citation fleet consisted of the

CitationJet, the Citation S/II, the Citation III, and the Citation Ultra. The development of the Citations VI and VII were announced the same year as the X, since they were both small modifications of the Citation III they were developed much more quickly than the X. These aircraft are depicted in Figure 4 and the corresponding details are summarized in Table 4.



**Figure 4: CitationJet, Citation S/II, Citation III
Citation Ultra, Citation VII ([1], [4])**

Name	Year Introduced	Typical Seating	Wingspan (ft)	Max cruise speed (ktas)	MTOW (lbs)	Range (nm)
CitationJet	1989	5	47	380	6650	1485
s/II	1984	8	52.2	408	12300	1839
III	1982	6	53.5	472	9979	2346
V/Ultra	1987	8	52	430	16650	1960
VI	1992	10	59	473	24000	2345
VII	1992	8	53.5	476	22450	2220

Table 4: The Citation Family before the introduction of the Citation X

When the Citation X was announced, the previous Citation family, the 650 series, which includes the Citations III, VI, and VII, was eight years old. In 1990, Cessna made a proposition for an improved 650 model to their Customer Advisory Council (described in Section 7.1). The council was interested in some new elements such as increased speed and a pressurized baggage compartment. This pushed Cessna towards the Citation X program, which became the new 750 series.

Moreover, Cessna wanted to improve the image of the Citation family. The Citation models that emerged in the 1970s were originally intended to be practical and with good handling qualities. Consequently, they turned out to be much slower than the competing Learjets. Cessna had difficulties in shedding of the popular image of the Citation as a slow airplane, even though their jets had eventually become as fast as the competition.

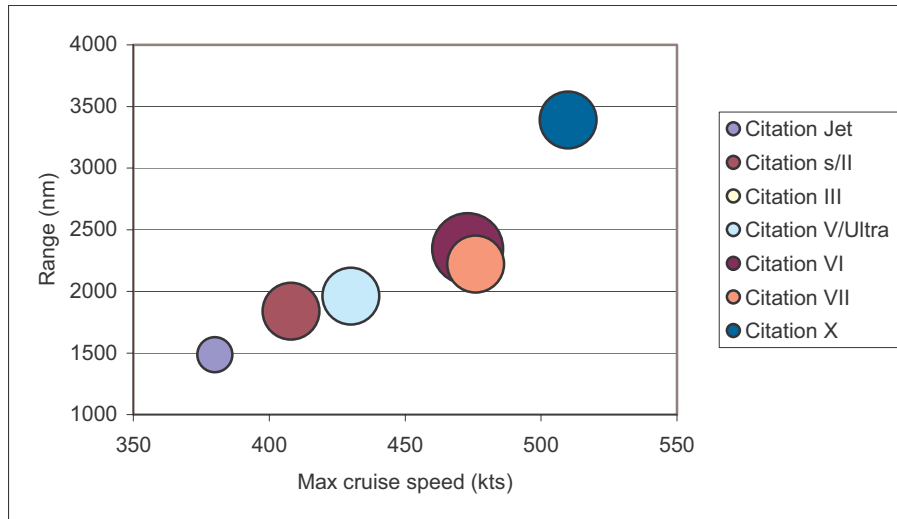

Figure 5: The Citation family in 1992 [1]

Figure 5 shows the range and speed of the Citation jets either available or in development in 1992. The Citation X corresponds to a significant increase in both range and speed compared to these aircraft. When looking at the Citation fleet available in 2003 (Figure 6), the Citation X is still the high-end aircraft offered by Cessna. In both of these plots, the width of the bubbles corresponds to the number of passengers the aircraft can accommodate.

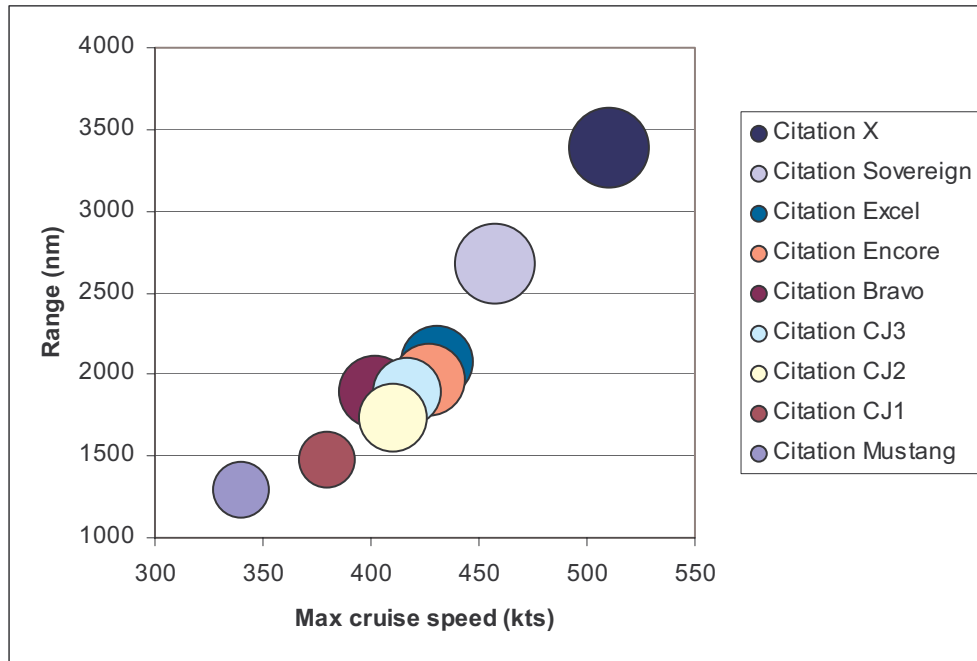

Figure 6: Citation family in 2003[1]

Despite Cessna’s long history of building business jets and the number of aircraft in the Citation family, the Citation X was in many ways a completely new aircraft. The wing, tail, tail cone, gear, and systems are designed from scratch and not based on pre-existing aircraft. The Citation X is also the first aircraft to use a Rolls-Royce engine and fully-integrated avionics. Although the Citation X may look similar to its predecessors, it is almost entirely composed of new parts. Part commonality is limited to some cockpit controls, the windshield, and the tail light bulb. The pressure bulkhead is also similar to previous designs. The Citation X has the same fuselage diameter as the Citations VI and VII; however, the wing attachment to the fuselage is different from the attachment in any previous Citation [3]. This will be further explained in Section 6.4.1.

3.3. Market Context

The business aircraft market can be divided into several sectors, each intended for a different customer profile. These sectors are determined by the price of the airplane, its range, the number of passengers it can carry, and its level of luxury. The aircraft at the higher end of the market have more range and larger cabins, providing more comfort to

the passengers. For each sector, the Table 5 shows the main characteristics and some representative aircraft.

Category	Price (million \$)	Seating	Range (nm)	Cessna	Other
Light	< 6	< 7	< 2000	CitationJet	SJ30 (Swearingen) Premier One (Raytheon)
Medium	4 to 11	6 - 8	1500 - 3000	Citation 2, 3, 5, 6, 7, Bravo and Excel	Learjets (Bombardier) Astra (IAI) Hawker 800 and Beechjet (Raytheon)
Medium to Large	11 to 18	~ 8	~ 3000	Citation X	Galaxy (IAI) Falcon 2000 (Dassault) Hawker 1000 (Raytheon)
Large	> 18	8 - 15	4000 - 5000		Challenger (Bombardier) Falcon 900 (Dassault) Gulfstream 4
Super large	> 30	> 15	> 5000		G5 (Gulfstream) Global Express (Bombardier) Boeing Business Jet

Table 5: Business Jet Market Sectors [5]

Cessna is one of the three most important business aircraft companies, along with Bombardier and Raytheon. Gulfstream is a major high-end player, and Dassault and IAI are small and medium players, sometimes struggling to remain in the market [5].

Cessna has a very strong position in the light-jet sector, claiming in September 1995 to have captured 86% of the market [6]. Its only weakness is in the upper end of the market. In the past, Citations were efficient and comfortable, but had low performance. In 1990, the market was emerging from a slump [7]. Facing growing international use and the entrance of many new, higher-performance products, Cessna set out to launch a new mid-size airplane with "preemptive range and speed" as Russ Meyer, the president of Cessna, described in *Business & Commercial Aviation* [6]. The clear objective of the Citation X is speed supremacy on transcontinental flights above all other business aircraft, including those in the \$ 25-million to \$ 30-million class.

Citation X is aimed at three customer profiles [6]:

- Fortune 200-size corporations that historically have operated large fleets of business aircraft, including older Gulfstreams, Challengers and Falcon Jets, plus mid-size aircraft such as late-model Hawkers and Citation VIIIs.

- Fortune 1000-size companies that operated mid-size aircraft such as Learjet 60s, Falcon Jet 20s and Citation IIIs, and that "cannot or will not upgrade to a large airplane."
- Individuals all over the world, particularly entrepreneurs, "who understand high-performance aircraft."

Even if some early commentaries said that for business jet users, speed is less important than luxury and range [8], Citation X sales have proved otherwise. Despite competition from newer business jets offering larger cabins and longer range at lower prices, the Citation X remains popular precisely because of its speed advantage over rival aircraft [9].

The customer basis for the Citation X can be divided into three groups, each of which represents approximately the same number of aircraft sold [3]:

- Corporate customers
- Individuals
- Netjets, a fractional jet leasing company

The two first profiles were targeted by Cessna and the last one was unexpected. Fractional ownership is a recent phenomenon that has permitted the entry costs of business jets to decrease to \$1 million or less. This creates a new category of customers. In 1998, fractional ownership pioneer Executive Jet Aviation estimates that 80% of its new clients have had no prior experience with business aircraft ownership [10].

3.4. Competition

Cessna aimed for a niche in the market: the high-speed business jets. This niche was, and still is, with the exception of the Citation X, mostly unexploited [2]. This can be seen when looking at the various jets offered by Netjets. Netjets represents a third of their customer basis for the Citation X offers in 2003 and offers fractional ownership for:

- four light cabin jets: Cessna Citation Bravo, V Ultra, Encore and Excel
- five midsize cabin jets: Cessna Citation VII and X, Raytheon Hawker 800XP and 1000 and the Gulfstream 200
- five large cabin jets: the Dassault Falcon 2000, the Gulfstreams IV-SP, V and V-SP and Boeing Business Jets

Figure 7 shows the unique position of the Citation X. Light cabin business jets carry a small number of passengers at speeds below 480mph and a range lower than 2000sm. Other midsize jets offer seating for less than 10 passengers with ranges between 2000 and 4000sm and with high-speed cruise of less than 540mph. As for large cabin jets, they offer much wider hulls and much longer ranges, and are therefore preferred for transoceanic use, but cannot compete with the Citation X in terms of speed within North America. In Figure 7, the width of the bubbles corresponds to the number of passengers the aircraft can accommodate. The Citations V Ultra, Encore, and Excel cannot be distinguished on this plot since they overlap.

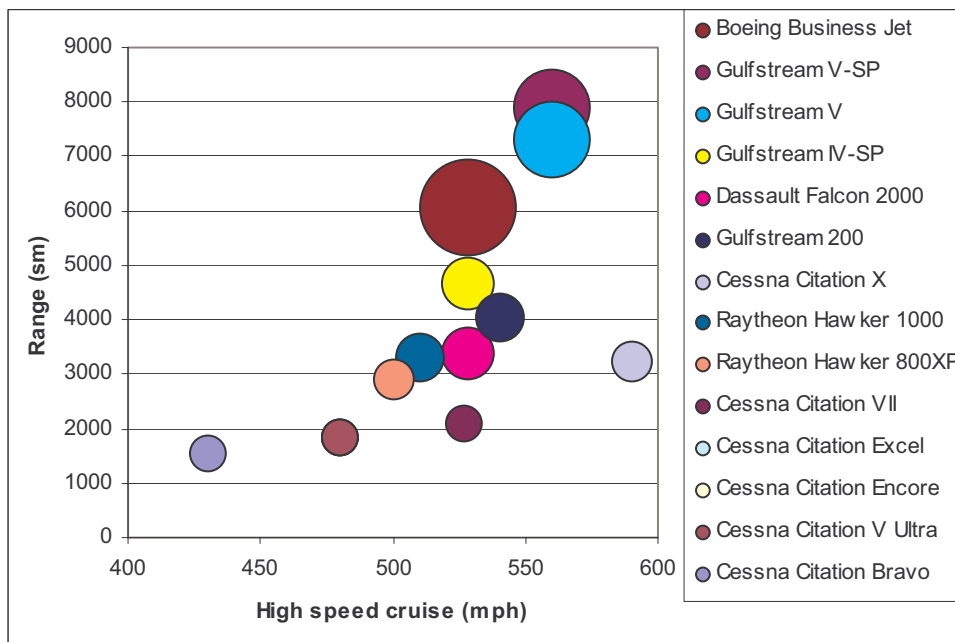

Figure 7: Range and high-speed cruise capabilities for jets offered by Netjets [35]

Customers who have purchased the Citation X most frequently mention the following aircraft as runners-up: the Galaxy Astra 1125SPX (which was renamed Gulfstream G100), Raytheon Hawker 800XP, Learjet 60, and Dassault Falcon Jet 50EX. These aircraft have ranges between 2500nm and 3000nm and medium sized fuselages that can carry the same number of passengers as the Citation X. What was unexpected initially is that the Citation X often competed with the larger, more luxurious jets that can be twice as expensive. In fact, operators also looked at the Dassault Falcon 2000, Challenger 601-3R and 604, and Gulfstream IVSP [12]. These are much larger aircraft

with wider fuselages and are designed to carry about twice as many passengers as the Citation X.

When considering the Citation X, the first question that is asked is what difference its higher cruise speed makes on trip times. Operators who have upgraded from the Citation III to the Citation X have reduced trip times from three to two-and-a-half hours for a trip from Minneapolis to Phoenix.

In comparison with competing aircraft, the fuselage diameter size is often seen as a disadvantage for the Citation X. The operating history shows that, on average, three passengers use this aircraft for a one hour and 28 minute flight [12]. Cessna argues that the shorter the flight, the less comfortable the cabin has to be. When the aircraft was designed, Cessna expected that the chosen diameter of the fuselage, which yielded significant aerodynamic advantages in their quest for speed, would be accepted by the customers who enjoy the possibility of flying coast to coast when the need arises, but have a much different typical utilization of the aircraft.

Table 6 presents a comparison of the Citation X with a few of its competitors. The range of the Citation X is not the same as the one published by Cessna and the one found in Jane's [1]. This is intentional in order to keep the same assumptions (take off weight, number of passengers) made by [11] and keep the comparison meaningful.

	Model	Typical crew, Pass. seating	Maximum cruise speed KTAS	Service Ceiling at MTOW (ft.)	Range (seats full) NM	Total direct cost per flight hour
Learjet	60	2, 6	466	42400	2218	\$1,294
Hawker	700A	2, 8	435	41000	1911	\$1,693
	800A	2, 8	455	39000	2172	\$1,463
	800XP	2, 8	455	39000	2470	\$1,272
	1000	2, 8	468	43000	3105	
Falcon	50	2, 9	480	41000	2863	\$1,957
	50EX	2, 9	480	41900	3301	\$1,654
	2000	2, 8	480	43000	3000	\$1,463
	2000EX	2, 8	480	43000	3800	\$1,520
Challenger	600	2, 9	458	39000	2800	\$2,508
	604		470		4077	
	Continental	2, 8	470	41000	2920	\$1,425
	601-3R	3, 19	480	22700	4077	
Galaxy	Astral 125					
	SPX	2, 6	480	41000	2286	
Gulfstream	IVSP	2, 14	503	41000	4200	\$2,038
	IV	2, 14	438			\$2,238
Citation	III	2, 7	465	43000	1770	\$1,655
	VII	2, 7	448	43000	1693	\$1,471
	Excel	2, 7	430	44000	1550	\$1,156
	X	2, 8	510	43000	2738	\$1,630
	Sovereign	2, 12	457	47000	2820	\$1,350

Table 6: Comparison of the Citation X with a few competitors [11]

4. Value Proposition

4.1. Value expectations of stakeholders

The value of an aircraft is measured not in terms of its worth to its stakeholders. That is, the value of an aircraft can be measured in terms of its “particular worth, utility, benefit, or reward in exchange for [the stakeholders’] respective contributions to the enterprise.” [11]

There are three phases to determining an aircraft’s worth or value to its stakeholders: value identification, value proposition, and value delivery. Value identification is the process of identifying the stakeholders, and determining what each expects from the aircraft—in terms of performance, cost, comfort, and other criteria. In return, a value proposition is developed, which proposes design objectives that aim to meet the stakeholders’ expectations. Finally, the value delivery is the implementation of the value proposition, i.e. the development of an aircraft that meets the stakeholders’ expectations. The process is illustrated in Figure 8 below:

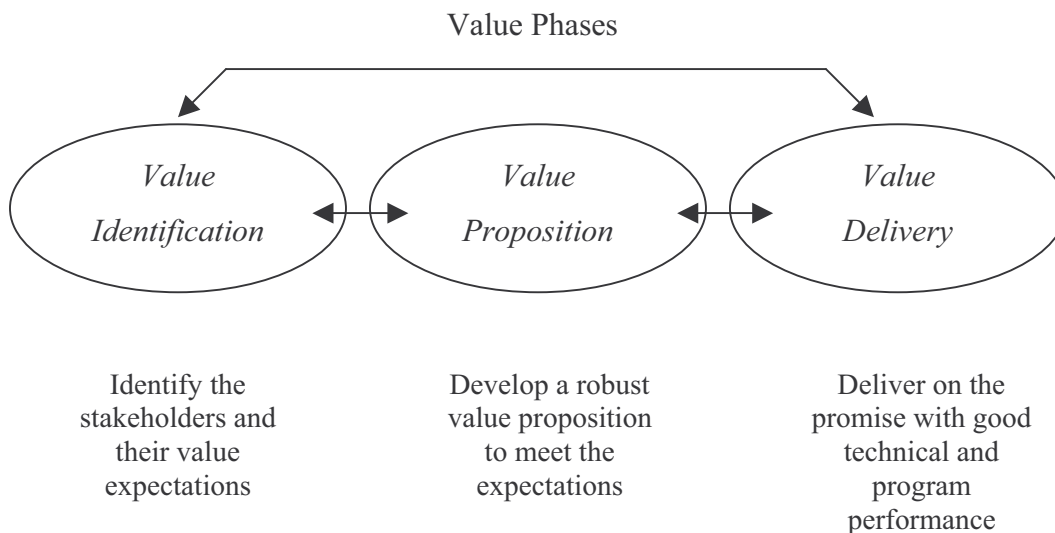

Figure 8: Phases of Value Creation

This section of the case study will identify the key stakeholders of the Cessna Citation X, the objectives and expectations of the stakeholders, and the design elements of the Citation X that address these expectations.

4.2. Stakeholders

A stakeholder can be defined as “any group or individual who can affect or is affected by the achievements of the organization’s objective.” [14] The stakeholders for the Citation X have been divided into eight groups, as shown and defined in Table 7 below.

Stakeholder Category	Stakeholder Members
Customers/Acquirer	Individuals (entrepreneurs, politicians, celebrities, etc), corporations, who will own the finished products
End Users	Passengers, pilots, crew, and maintenance personnel [16]
Shareholders	Textron Shareholders
Employees	Management, engineers, assembly/production, support staff [14]
Unions	IAM & AW
Suppliers	145 suppliers. Primary suppliers: Rolls Royce, Honeywell, Kaiser, Microtechnia, Hamilton Sundstrand, and Parker. Responsible for: components, materials, sub-systems
Partners	Rolls Royce, Honeywell, and other key suppliers
Society	Communities surrounding airports and development sites.

Table 7: Citation X stakeholders

4.3. Value Identification

Each stakeholder contributes specific expectations to the development of the aircraft. Both the nature of the contributions and the expected benefits vary among the general stakeholder groups. This section will address each stakeholder’s contribution and expected return value. Later sections will discuss how Cessna addressed these expectations and evaluate the success of the value proposition.

4.3.1. Customers/ Acquirers

The acquirers of business jets are primarily concerned with the comfort, security, and utility for passengers of the finished product, as well as cost-effectiveness. A customer or corporation will likely expect a business jet to aid in increasing the passenger’s productivity. Fractional ownership programs such as Netjets are concerned with technological reliability, comfort, efficiency, and low costs. Some of these goals can be met through increased flexibility in schedules due to higher aircraft availability and

fewer take-off constraints. Furthermore, there are a greater number of flight destinations if the aircraft has access to more airports. High cruising speeds are also attractive as they lead to shorter flight times. The cabin design should provide the utilities necessary for office work to be done in flight, as well as a comfortable and motivating environment.

The appearance of a business jet must be flexible. It must allow for anonymous, low-profile travel, but also be able to serve as a status symbol that enhances the customer's image.

4.3.2. End users

The end users of a business jet include the passengers, pilots, crew, and maintenance personnel. The passengers, who may also be the customer, are concerned primarily with the comfort and utility inside the cabin. The general comfort of a cabin includes spacious seating, lavatories, entertainment, low engine noise and low vibration. For business travelers, productivity is essential. It is obtained through shorter flight times, high dispatchability and resources for in-flight work such as communications and conferences. Other end-user expectations are "peace-of-mind" and on-board security.

The pilots and crew of the aircraft expect comfort, reliability, and controllability of the aircraft, and benefit if less additional training is necessary to operate the aircraft. The maintenance personnel expect safety, and benefit from easily performed repairs and system checks.

4.3.3. Shareholders

In 1992, Textron bought Cessna Aircraft (NYSE. Ticker: TXT) [1]. Before Textron, Cessna was owned by General Dynamics. Textron's involvement with Cessna has been strictly financial, meaning that there is no involvement of upper management in the design of the airplane [3]. One of its financial requirements is that the Citation X provides a 12% profit per aircraft. The shareholders benefit through capital gains and dividends paid out by Textron. A positive performance by Cessna in the form of a successful program will affect Textron's share value and could encourage shareholders to invest further.

4.3.4. Employees

The employees of Cessna include the management, engineers, assembly and production staff, and support staff. The employees benefit financially from acceptable wages and benefit packages, but more importantly, the employees will be motivated, innovative, and productive if given employment security, a comfortable and interesting work environment, and the opportunity for career growth and further education.

4.3.5. Unions

The role of a union is to ensure job security, adequate wages, and an acceptable working environment for its workers. The only union representing the employees at Cessna is the International Association of Machinists and Aerospace Workers (IAM & AW). The percentage of machinists at Cessna who are represented by the union varies between 50% and 70% [1]. Unlike at Boeing, there is no union representing the engineers at Cessna.

4.3.6. Suppliers

Every purchased component of the aircraft comes from one of many suppliers and partners. In addition to the propulsion and avionic systems, Cessna was highly involved with the suppliers for all the parts. One way that suppliers benefit is by having Cessna test the parts: many of the prototype parts were received on consignment—meaning that payment was made only for the final product, and unusable parts were returned free of cost. In return, Cessna plays an important role in testing and certification of the parts [1]. This process can be expensive, so in order to keep acquiring costs low, at least three bids are solicited before a part is purchased. Cessna also tries to use existing parts, as they are already proven reliable, and if an existing component cannot be found to meet Cessna's specifications, it will ask the suppliers to modify the existing part before designing a new one. [3]

Other reasons why a relationship with Cessna is beneficial are the opportunity to expand into new markets, expand the corporate image, growth in market share, as well as general sales.

4.3.7. Partners

The main partners are Honeywell, for the avionics, and Rolls Royce, for the engines [1]. The benefits of the suppliers extend as well to the partners. The partners, however, have a closer relationship with Cessna, which leaves more room for negotiation. It is easier for Cessna to substitute a basic component supplier than it is for them to replace a partner that supplies the engines. An interesting tactic that Cessna uses to insure the highest quality work from their partners is to make the partners responsible to Cessna's customers, rather than to Cessna itself. This relieves Cessna of some responsibility if a problem occurs, and puts the onus on the suppliers to be responsible. It also creates a close relationship between the suppliers and the customers. Partners will mostly benefit image wise, by co-designing the fastest business jet. Other factors might be growth in market share and increased sales.

4.3.8. Society

The society that is directly affected by the Citation X can be divided into two sets of communities: the residents near the airports and the residents near the development site [3]. The communities near the airports require acceptable noise and emissions levels, which are controlled by the FAA and transit authorities. Safe operations are also essential. The communities around a development site will be concerned with environmentally friendly grounds, economic development because of the site (for instance, the creation of jobs, circular flow of income, etc), and community service.

4.4. Value Proposition

Cessna's value identification phase for the Citation X has been described. This value identification led to an initial value proposal that was submitted to the Customer Advisory Council. In this proposal, Cessna offered to create yet another upgraded Citation. This proposal was refused and the CAC pushed for a brand new aircraft with some new features such as the pressurized baggage compartment. This second proposal was accepted and served as the baseline for the Citation X. Figure 9 presents the various phases of the value proposition formulation.

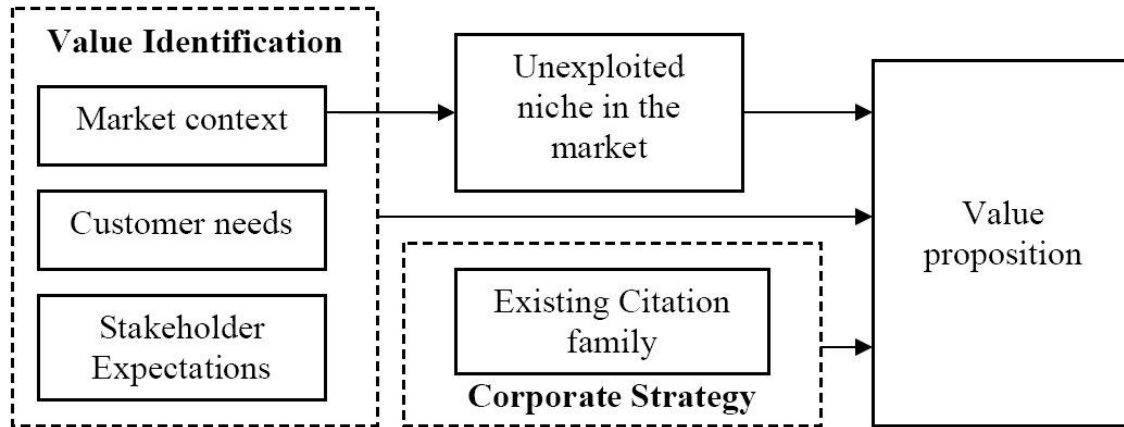

Figure 9: Value Identification and Value Proposition

The value proposition for the Citation X is:

- A high end product to complete the Citation family
- A fast aircraft with an maximum operating Mach number of 0.9
- Capable of the following mission: NY-LA 85th percentile head wind
- Sized in order to fit a double club (8 passengers) with an additional seat in front
- Pressurized baggage compartment
- Pilot friendly through the minimization of pilot work load
- Easy to maintain
- Cost efficient for non-recurring, recurring and operating cost

5. Design process

5.1. Value delivery process

The value creation process goes through various channels. For instance, either high level requirements or management techniques can be used to achieve value. In this section, high level requirements and the major design choices made early on in the program will be identified. This report will also identify the values that will be created through other channels.

Certain values can be translated into high level requirements. For example, the mission New York to Los Angeles directly yields the range of the aircraft. On the other hand, certain goals including making the aircraft easy to maintain cannot be met by quantifiable requirements. These values are instead created through various program decisions such as the choice of management techniques and systems engineering methods. Ensuring easy maintenance is a good example of how management choices can create value. The use of IDTs including maintenance personnel encourage a design for an easily maintainable aircraft. These management techniques will be described in more detail in section 7.

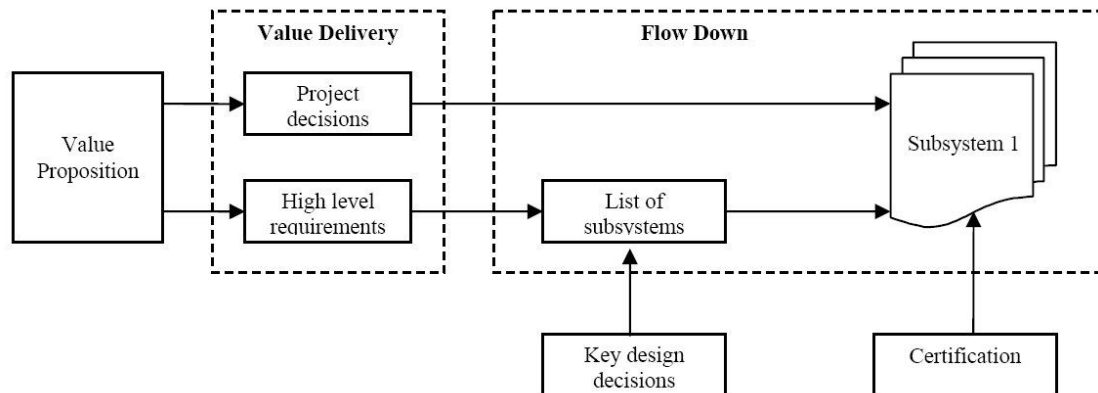

Figure 10: Value Delivery and Requirement Flow Down

The program decisions made for the Citation X include the use of IDTs and TQM. Common tools, such as CATIA, were chosen in order to make sure that all the parts designed will fit together. Design re-use was also a consideration. This drove certain program decisions, although this aircraft was different enough from the previous

Citations that most of the parts were eventually modified or designed specifically for the Citation X. Testing was made throughout the design process and the prototypes were made with production tools. This last decision was to ensure that the first production aircraft would be very similar to the prototypes and would therefore minimize the risk of flaws in these aircraft.

5.2. High-level requirements

The high-level requirements are the measurable criteria that a given airplane must fulfill. In the case of a business jet, they consist of safely transporting passengers on long distance flights and with the lowest possible acquisition and operating costs. In fact, for business jet customers, carrying out a given mission is the first criteria, and costs are second. The requirements are defined as to attract prospective customers.

The Citation X was to be certified initially by both the FAA and the JAA. In addition to the requirements imposed by these regulations, the high level requirements set for this aircraft include:

- Maximum operating Mach number: 0.9
- Optimized for cruise at $M=0.88$
- Optimized for long range missions at $M=0.82$
- Range $>3000\text{nm}$ specified by the mission objective New York to Los Angeles
- Take off and landing distances set in order to make the aircraft operate out of most airports (although not the smallest airports)
- Fuselage long enough to fit double club and an additional seat
- Ceiling of 51,000 ft
- 12% profit per aircraft

5.3. Design goals

In addition to high level requirements, there are many unquantifiable goals that drove the design of the aircraft. The goals are specific values that can be optimized in order to maximize the value delivered to the stakeholders. For the design of the Citation X, these goals were:

- Minimize operating costs including:
 - Minimize fuel burn
 - Minimize maintenance time
- Minimize development cost
 - Maximize design re-use
- Minimize acquisition cost
- Maximize comfort:
 - Minimize cabin noise
 - Maximize cabin volume

5.4. Key design decisions

Early in the design, Cessna made some key decisions which drove the design of this aircraft. One of the most significant was the choice of an all glass cockpit and the choice of Honeywell as their partner for this aircraft. Honeywell was to have certified this system on another aircraft before the Citation X. Although this turned out not to be the case, it significantly influenced the selection of Honeywell.

The requirement for speed and the goal to make a high end Citation led to a tradeoff for the fuselage diameter. In order to meet the speed goal efficiently, Cessna wanted to keep the fuselage diameter as low as possible and therefore reduce the drag of the aircraft, while comfort pushed for a larger diameter. The decision to reuse the same fuselage diameter as the Citation VII was then made. Design and tooling re-use also motivated this decision, although this was not practical in the end. Nevertheless, comfort was enhanced by another decision: the wing was designed to go under the fuselage, leaving more room in the fuselage for the passengers.

The fuselage diameter, along with the requirement on the fuselage length, led to the sizing of the aircraft. This allowed another major decision: the choice of Rolls Royce as the second major partner for this aircraft. Once again, Cessna chose an engine which had a proven core which was already in use on the Boeing V-22. The 5 to 1 bypass ratio version of this engine was chosen solely for its fuel efficiency. Noise considerations were seen as a bonus.

These choices were key in the design of this aircraft. These decisions gave the size of the aircraft and its weight and therefore added significant constraints to the subsystems.

5.5. Requirements flowdown

The requirements will flow down in two different ways. First, high level requirements may create the needs for given subsystems. Once a list of subsystems exists, each subsystem will have its own specific requirements, which are the results of the high level requirements and are also influenced by the key design decisions previously described and the need for certifiability.

Certification flows down to each individual subsystem, but it is important to note that the systems must also be certified as a whole. The Citation X is designed to meet both Damage Tolerance and Fail-Safe Criteria. Damage Tolerance criteria provides in-depth inspection criteria for all critical parts. Fail-Safe criteria require that, even if a part fails, the aircraft can continue to fly with structural integrity and proper systems operations. This leads to the requirement for redundancy. For the Citation X, redundancy is included in all critical systems, such as the flight controls, the hydraulic systems, the electrical systems, the brakes, and the environmental system. This allows a pilot to land the plane safely even if the main systems fail, with no additional action required by the pilot to engage the backup systems. In the worst case, there are mechanical backup systems for the flight controls.

5.5.1. Need for subsystems

The size, weight and speed of this aircraft made the control forces strong enough to require hydraulic actuators in order to meet the FAA requirement that a male operator in the fifth percentile can exert sufficient force to move the controls. The Citation X was the first Cessna aircraft to use hydraulic controls.

The slats also flow down as a required subsystem on this aircraft. The speed requirement drove the choice for highly swept wings. This configuration created pitch up at stalls, which are forbidden by regulation. In order to solve this issue, leading slats were added to the wings. This subsystem also improved handling qualities for the aircraft and

reduced landing speeds. Although many advantages can be drawn from the presence of slats on the aircraft, they add weight and complexity to the aircraft and were not deemed necessary initially. This also shows the iterative process of design which adds required subsystems. Unfortunately, as will be discussed later on, the decision to add slats was made quite late in the design.

5.5.2. Subsystems requirement flow down

Size and weight are given as requirements for each subsystem as well as many others. The aircraft contains far too many subsystems for it to be reasonable to explicitly and completely show the flow down. Instead, we will show on some key subsystems how the requirements flow down. In section 6.3, the various subsystems will be described in detail and insight on the requirement flow down for these subsystem will be given.

The design of the wing was driven essentially by the speed requirement for this aircraft. This led to the highly swept wing and also to the choice of a supercritical airfoil for optimized performance at high Mach numbers by increasing the critical Mach number and reducing drag. Other more detailed requirements included the wing area as a function of the gross weight of the aircraft and the required landing speed, the volume to accommodate the various subsystems such as actuators, flaps, slats and fuel tank.

Another subsystem of interest is the fuselage. The decisions for the choice of the diameter have already been discussed but speed also influenced a major design choice on this aircraft. The speed requirement drove the decision to use area ruling in the aft part of the fuselage.

6. Detailed vehicle description

6.1. Performance

This section discusses the performance characteristics of the Citation X. Unless otherwise noted, the sources consulted for this part were [17] and [32].

6.1.1. Operating Limitations

Crew/Occupants

The minimum flight crew for all operations is one pilot and one copilot. The maximum number of seats is 14, which gives room for 12 passengers and the flight crew.

Weight

The maximum airplane weights are limited by the structural strength of the airframe. The maximum ramp and takeoff weight depend strongly on the climb requirements and the takeoff field length. These are expressed below in Table 8. Other factors affecting maximum landing weight are the available landing distance and the energy that the brakes are able to dissipate. These will be further discussed in sections 6.1.2 and 6.1.4. During flight conditions the wings have to sustain the entire weight of the aircraft and become most susceptible to stress when they are empty. Wings that contain no fuel provide less structural support at the wing-fuselage joints. This is the main reason for a zero fuel weight limitation.

Ramp Weight	36,400 lbs
Takeoff Weight	36,100 lbs
Landing Weight	31,800 lbs
Zero Fuel Weight	24,400 lbs

Table 8: Maximum Certified Weight Limitations

Center of Gravity

The location of the center of gravity (CG) depends on weight and its distribution. These two parameters indicate much about the stability of the aircraft. The center-of-gravity limit envelope is illustrated in Figure 11. The CG is measured from a reference

point that is located at the forwardmost point of the airplane. Depending on the gross weight, the CG can shift between 405 and 429 inches aft of this reference point, before it exits the lightly shaded region of the CG envelope and is no longer statically stable.

Pitch stability increases as the CG moves forward. At a certain point the horizontal stabilizer cannot provide enough counter-force to rotate the aircraft appropriately during take-off or flare on landing. On the other hand, if the CG moves too far backwards, a nose up pitching movement will occur, which the horizontal stabilizer may not be able to counteract. As a result, the aircraft could stall, followed by a spin, with little chance of recovery due to ineffective flight controls. For crew-only flights, the CG is usually prevented from moving past the aft CG limit by adding ballast fuel in addition to the total fuel required for a specific flight. Ballast fuel is strictly unusable and if burned can cause the CG to exit the CG envelope. The later models however, come with new cabin furniture, which moves the CG forward and thus replaces the ballast fuel in most cases.

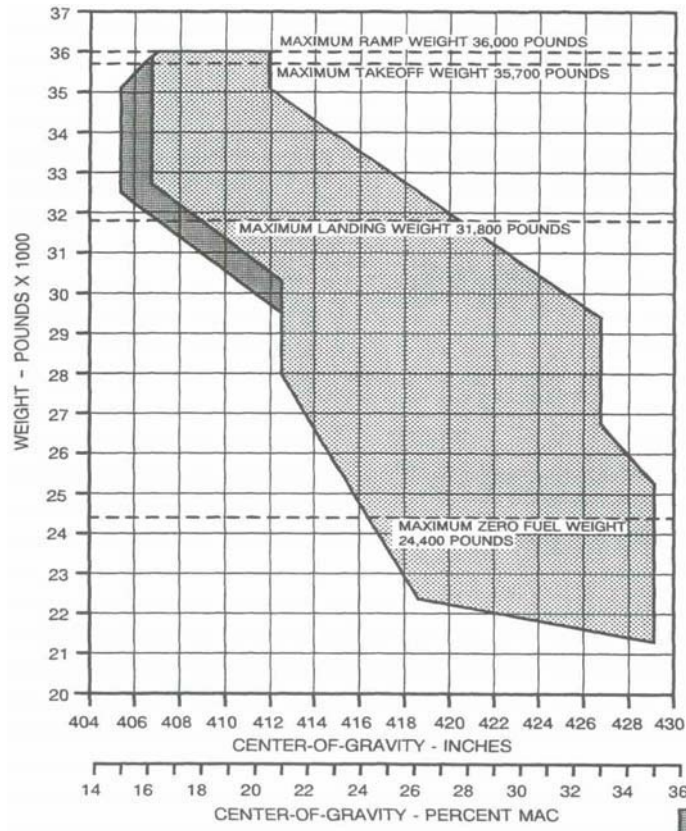

Figure 11: Center of Gravity Limits

The two CG limits 407” and 429” at high and low weights respectively are illustrated on the aircraft diagram in Figure 12. The CG envelope was largely sculpted around the fuel burn envelope, while considering the fuel burn loading at front and aft. Although the fuel burn curve is smoother, the vertical kinks are limits set by the handling qualities of the aircraft.

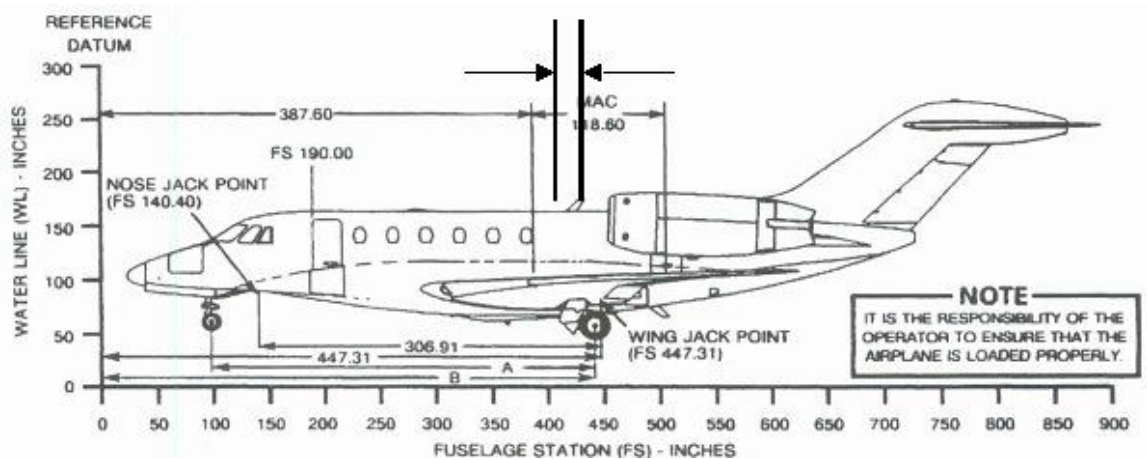

Figure 12: Center of Gravity Limits (2)

Altitude

The maximum operating altitude is 51,000 feet and can be read off from the design speed envelope. The ceiling is a design requirement; unlike previous Citation models, the X can reach this altitude in a reasonable amount of time. It is an altitude with little traffic. The maximum altitude for extension of flaps and landing gear is 18,000 feet. The normal cabin pressure limitation is 9.7 Psi Maximum Differential.

Speed

The design speed envelope is shown in Figure 13. The maximum operating Mach number of 0.92 is allowed at levels above 30,650 feet, where the 51,000 feet represents the operating ceiling. If the Mach trim mechanism is inoperative, the maximum operating Mach number is 0.82. The maximum operating speed below 30,650 feet is 359 knots, which is set by structural and performance limitations of the subsystems and birdstrike requirements. Below 8,000 feet, the speed is abruptly limited to 270 knots, which is due to regulatory reasons related to air traffic. The maximum operating limiting speeds must remain within the envelope in flight regimes, unless authorized for flight test or pilot

training. The dark shaded area represents the transient operation region. Continuous operation within this region is forbidden because at high altitudes the engines have a history of flaming out, which, combined with an operating point close to the stall speed, can cause dangerous scenarios.

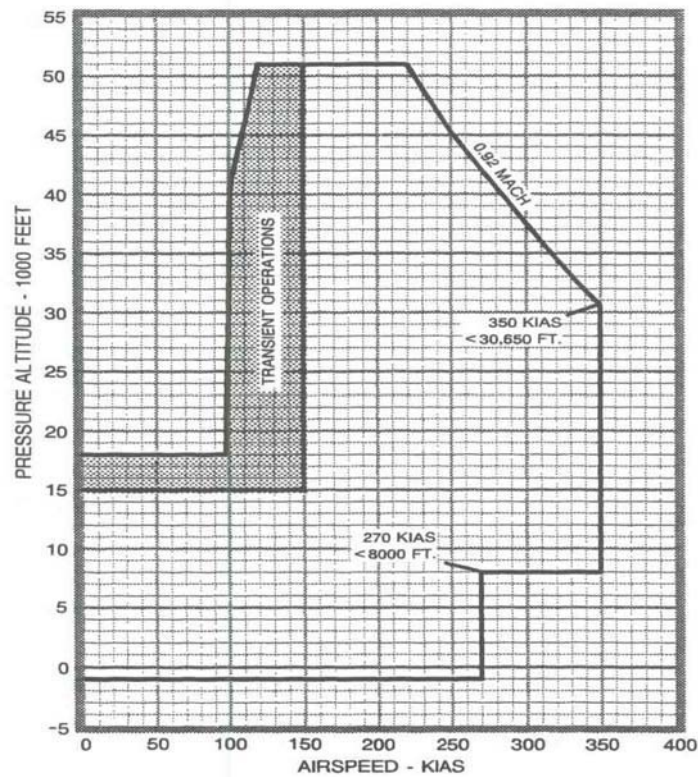

Figure 13: Design Speed Envelope

A V-n diagram for the Citation X is depicted in Table 15, which expresses the relationship between the permissible airspeed and load factors. For this diagram, the gross weight is 32,000lbs, the slats and flaps retracted to 0° and the speedbrakes are stowed. At an airspeed of 400KCAS the maximum load factor is 2.7, while at lower speeds the load factor limits are 1.5 and -1.0 . The remaining points on the V-n envelope are illustrated in Table 9.

Speed Pt.	KCAS	$N_z - g$
-----------	------	-----------

A	206	2.7
C	350	2.7
D	400	2.7
E	400	0
F	350	-1
H	148	-1
S	123	1

Table 9: V-n envelope limits

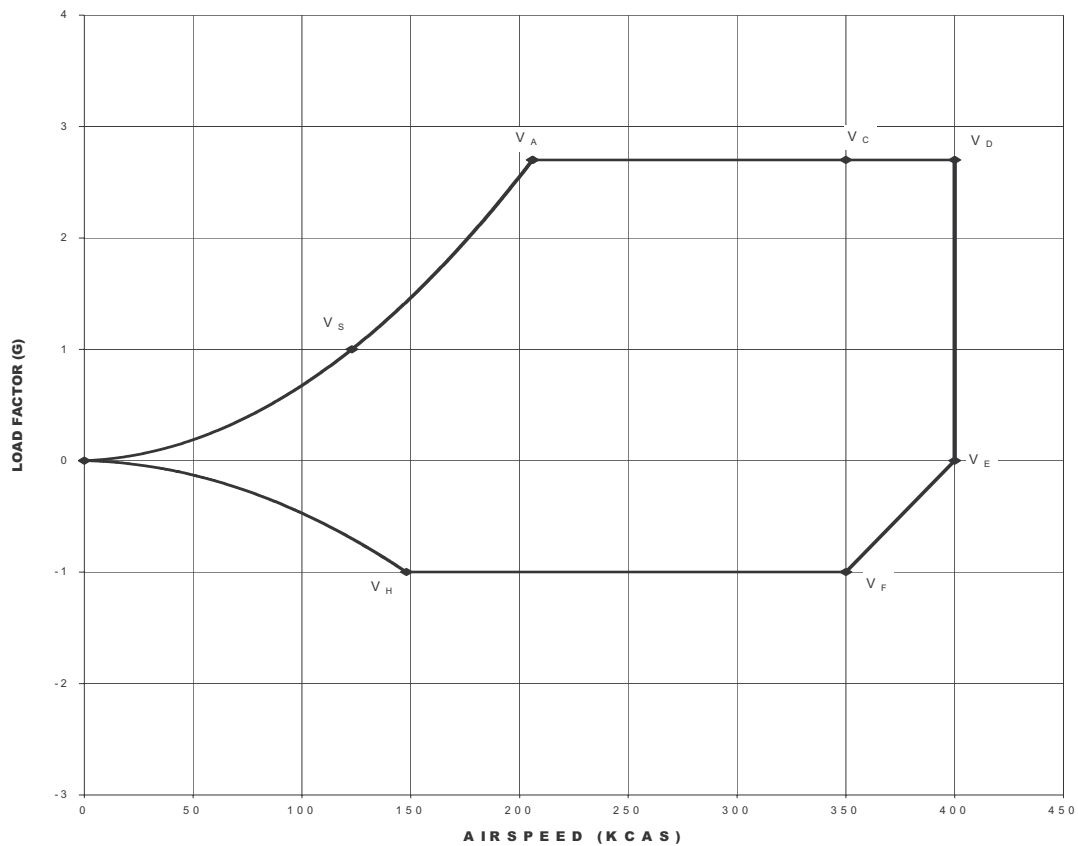

Figure 14: V-n Diagram [31]

The previous V-n diagram only accounts for one configuration; however there are over 300 V-n diagrams provided for different cases. Further load limits on the Citation X for other configurations are indicated in Table 10 below. The maximum load factor during landing is 3.5 at 31,800 lbs and at a sink rate of 600 ft/min.

Flaps – Up Position (slats retracted)	-1.0 to 2.7 at 35,700 lbs
Flaps – Up Position (slats extended)	0.0 to 2.0 at 35,700 lbs
Flaps – 5° to full position (slats extended)	0.0 to 2.0 at 35,700 lbs

Table 10: In Flight Load Factors

Maneuvering speed limits for various aircraft weights are illustrated in Figure 15. The maximum turbulent air penetration speed is 300 KIAS. The application of aileron and rudder controls and maneuvers that involve angles-of-attack close to stall should be confined below the maximum maneuvering speed.

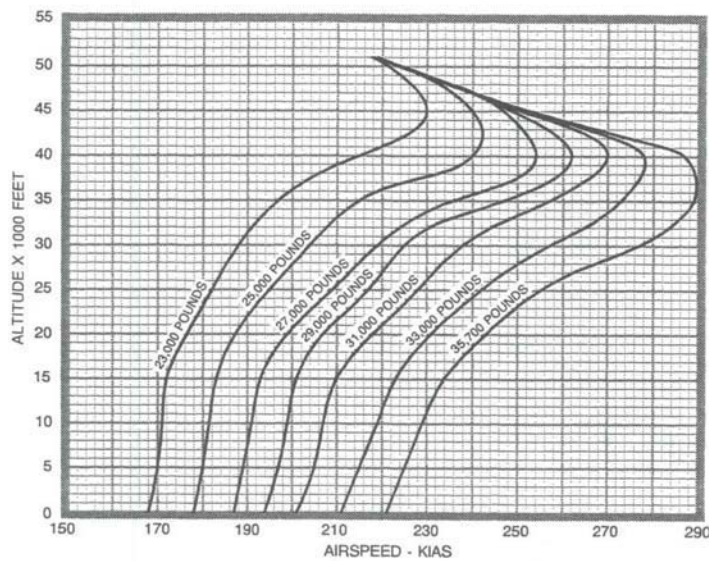

Figure 15: Maximum Maneuvering Speeds

High lift devices such as slats and flaps at 5° should not be extended at speeds above 250 KIAS. Flaps at 15° and full deflection should not be extended at speeds higher than 210 KIAS and 180 KIAS. The maximum speed at which landing gears can be extended and the tire ground speed is 210 KIAS. The minimum speed brake extension speed is 15KIAS above the minimum airspeed V_{Ref} (approximately $1.3 V_{Stall}$). The stall speeds range from 80 to 120 KCAS, depending on the flap settings. These are illustrated below in Figure 16.

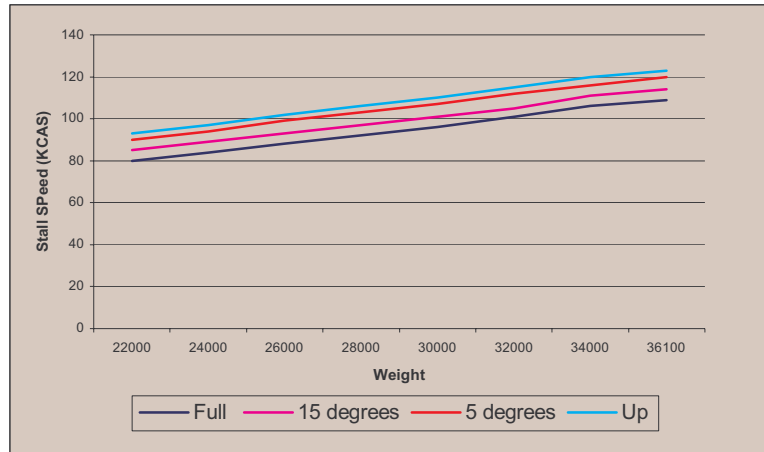

Figure 16: Stall Speeds for Different Flap Deflections

6.1.2. Take-off and Climb

There are three scenarios that will determine take-off field length: multiengine take-off, single-engine accelerate-go and accelerate-stop. The accelerate-go distance is the distance required to accelerate to the take-off decision speed V_1 , experience an engine failure, rotate, and climb to a minimum altitude of 15ft. The accelerate-stop distance represents the distance required to accelerate to V_1 and abort the take-off. Depending on the availability of these distances, the take-off weight can be significantly constrained. Based on the available take-off distance, a V_1 is selected and the take-off weight can be optimized accordingly.

In the more common case in which the available runway length exceeds the minimum required take-off field length, the performance data in Table 11 can be used. For a weight increase from 23,000 to 35,700 lbs, the minimum runway length moves from 4,500 to 7,500 feet. Similarly, the take off decision speed increases from 114 to 128 knots.

Weight (lbs)	23,000 – 26,000	26,000 – 30,000	30,000 – 33,000	33,000 – 35,700
V ₁ (KIAS)	114	114	122	128
V _R (KIAS)	116	115	122	128
V ₂ (KIAS)	129	127	132	137
Min. Runway Length (ft)	4500	5000	6000	7500
V _{Ref} (KIAS)	115	126	134	142

Table 11: Take-Off Performance with 15° Flap Deflection

Figure 17 shows the climb profile of the aircraft. The reference zero is the point at the end of the take-off field length, where the airplane is at a height of 35 ft. At this point, the landing gear is retracted. Although the climb rate is not specified, the aircraft must maintain the take-off safety speed V₂ and is not allowed to descend or level off. Next, the pitch altitude must be slightly increased and be able to maintain a single-engine climb gradient of 2.4%. For two-engine take-offs, the minimum climb gradients will be exceeded, however the pilot has to manage the power setting based on noise output and operational considerations. At 1,500ft the aircraft levels off and the flaps are retracted. Then the aircraft accelerates to the V_{ENR}, the best rate of climb, and the climb is resumed.

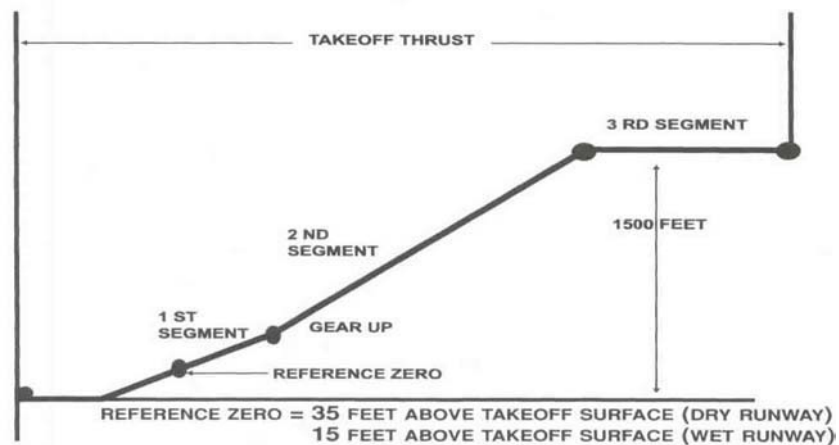

Figure 17: Take Off Flight Path Profile

The Citation X can climb to an altitude of 43,000 ft in approximately 30 minutes with its maximum take-off weight of 35,700lbs. When carrying much smaller weights it

can climb to an altitude of 25,000 feet in less than 10 minutes. The time to climb profile is summarized in Table 12.

Altitude (ft)	Time (min)		
	28,000 lbs	32,000 lbs	35,700 lbs
25,000	9	11	13
35,000	13	16	19
41,000	16	20	25
43,000	18	23	30
45,000	20	28	-
47,000	24	-	-

Table 12: Time to Climb Profile

The noise levels meet the requirements set by the FAA. At take-off, the EPNL (Effective Perceived Noise Level) is 72.3dB; at the sideline, it is 83.0dB and during approach, it is 90.2dB.

6.1.3. Cruise

The maximum range is obtained with a take-off weight of 36,000lbs, at an altitude of 43,000ft. The corresponding cruise Mach number is 0.82, which leads to a maximum range of 3300nm. The Citation X can thus easily travel across the continental United States, but is marginally adequate for transatlantic flights and incapable of transpacific flights.

Figure 18 shows a payload range diagram. Here it can be observed that for the Citation X the maximum payload can be carried for missions not exceeding 2,900 NM in range.

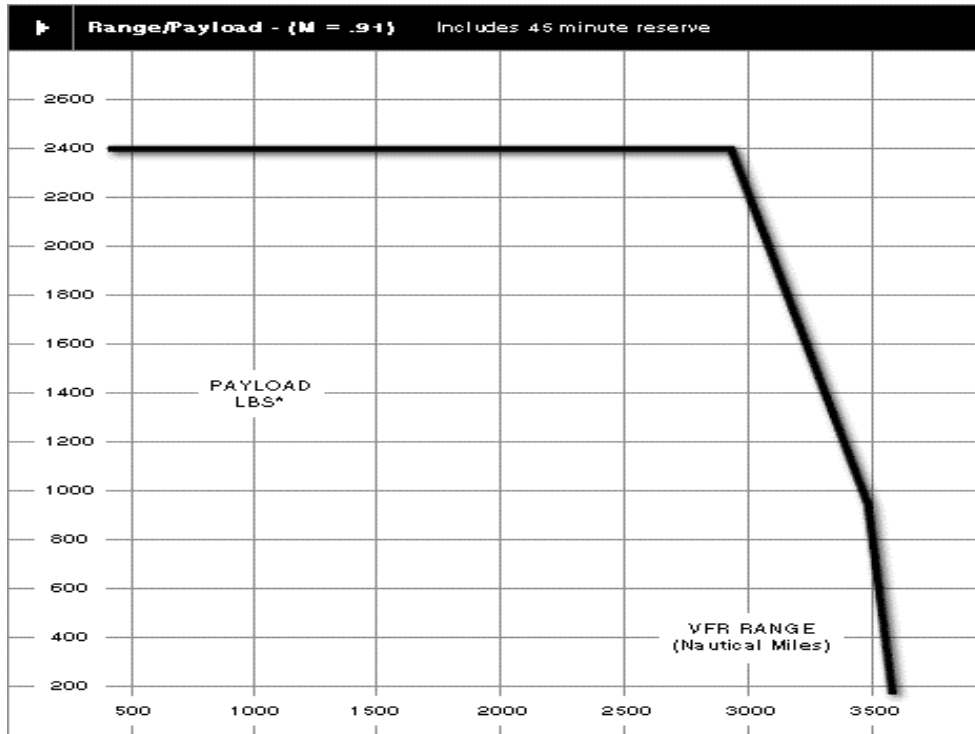

Figure 18: Payload Range Diagram

The fuel consumption of the Citation X during cruise conditions is shown in Table 13. At a common cruise altitude of 43,000 feet and at the maximum take off weight of 35,700 lbs, the Citation X has a fuel flow rate of approximately 2,000lbs per hour. This fuel consumption increases drastically at lower altitudes, which is why aircraft tend to reach the highest possible cruise altitude.

Altitude (ft)	Fuel Flow (lbs/hr)		
	28,000 lbs	32,000 lbs	35,700 lbs
37,000	2,772	2,758	2,752
39,000	2,493	2,476	2,474
41,000	2,241	2,228	2,217
43,000	2,013	2,008	1,994
45,000	1,806	1,799	1,784
47,000	1,625	-	-

Table 13: Fuel Consumption during Cruise Conditions

6.1.4. Approach and Landing

The aircraft should approach at a 3° angle to the 50ft-height point at an airspeed of V_{Ref} . During the approach the thrust setting is such that the 3° degree angle is maintained. At a height of 30ft, the thrust is set to idle and kept in that setting until the aircraft comes to a complete stop. Immediately on nose wheel contact hard wheel braking is initiated.

The minimum landing distance required, as well as the maximum approach velocities (V_{Ref} , V_{App}) are indicated in Table 14. For the maximum landing weight of 31,000 lbs, the Citation will need a landing distance of 3,820 feet and can have a maximum approach speed with the landing gears deployed (V_{ref}) of 132 knots.

Weight (lbs)	Distance (ft)	V_{Ref} (KIAS)	V_{App} (KIAS)
26,000	3,180	115	121
28,000	3,380	121	126
30,000	3,580	126	131
31,800	3,820	132	136

Table 14: Full Flap Landing Performance [17], [32]

6.2. Stability & Control

6.2.1. Longitudinal Stability

As was mentioned in 6.1.1, the pilot must ensure that the center of gravity remains in the acceptable range at all times in order for the Citation X to remain longitudinally stable. This task is complicated due to the unique CG characteristics of this aircraft. Because of tank location, wing sweep and fuel burn sequence, the CG of the Citation X, completely loaded with fuel, will initially shift forward then move aft, then forward, then aft again [17]. Moreover, without payload, the aircraft tends to have considerable aft CG. With few or no passengers on board, the zero fuel weight CG can be beyond the allowable aft CG limit. Therefore, in these cases, unusable ballast fuel must be carried.

6.2.2. Directional Stability

The Federal Airworthiness Regulations require that all natural modes be positively damped. During wind tunnel testing, it was noticed that the directional damping of the Citation X was marginal and quite possibly negative [3]. This occurred in two cases: above 29000 feet and at approach speeds with full flaps. Since the problem was marginal, it was not clear whether the real airplane would suffer from this problem. Engineers were not able to convince management that this was truly a problem until after the first flight of the prototype. The flight tests showed that the aircraft was not positively damped directionally in those two flight conditions and therefore did not meet the regulations. The solution, implemented late in the program, was to have a split rudder and separate yaw damping as described in 6.3.12.

6.3. Subsystems

This section contains a description of a number of significant subsystems of the Citation X, some discussion of Cessna's design challenges with some of them, and their design drivers. Except as indicated, all of the figures in this section are reproduced from [18].

6.3.1. Airframe

Materials

The Citation X airframe is made mostly of aluminum. It also has parts made of titanium and steel. Most control surfaces and a few other parts are made of Kevlar and carbon fiber composite materials [18]. The material choice was chosen to balance the high-level requirements of low operating cost, leading to light materials in order to minimize fuel costs, low materials and manufacturing costs, manufacturability and maintainability.

Fuselage

The fuselage is circular and employs aft-fuselage area-ruling in order to reduce drag at transonic speeds [1]. This decision was driven by the high-level requirements of high speed and low operating costs. The outside of the fuselage has service ports for the hydraulic system and an external toilet servicing station [17]. The interior of the fuselage is divided into four sections as shown in Figure 19: the nose cone; the interior, which includes the cockpit and cabin; the baggage compartment; and the tail cone [18].

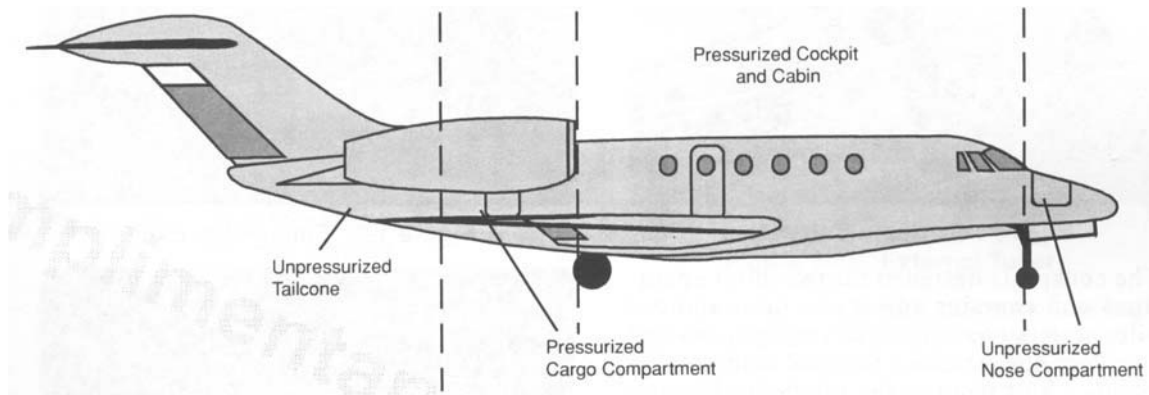

Figure 19: Fuselage Sections

Nose cone

The nose cone is not pressurized. It contains the radar, other avionics, oxygen bottles, pneumatics for emergency landing gear and brake operation, a backup battery for the standby instruments, the power steering accumulator, a fan for compartment cooling and external windshield air, and space for the nose gear to retract [18]. Most of these components will be discussed in more detail in later sections. Mounted outside the nose

cone are the pitot tubes, static ports, and ram-air temperature probes [18], as shown in Figure 20.

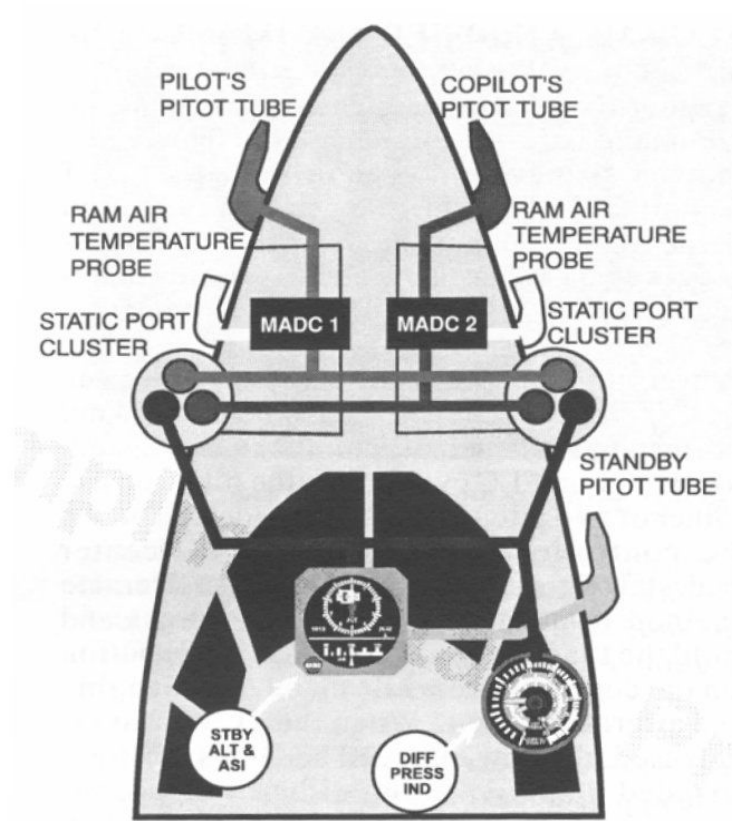

Figure 20: Pitot and Static Ports

Cockpit

The pressurized cockpit is designed to accommodate crew members in the 95th height percentile [17]. It has adjustable pilot and co-pilot seats with standard dual-control yokes and rudder/brake pedals [18]. The cockpit is separated from the cabin with sliding doors [17]. The cockpit contains two oxygen delivery systems [18]. The avionics will be discussed in Section 6.3.4.

The all-glass windshield in the cockpit is electrically heated and defogged and meets FAR 25 bird-resistance criteria [17].

Cabin

The pressurized cabin is 28.3 feet long and has a constant width of 66.8 inches. There are 68 inches of standup headroom. The cabin layout is chosen by the customer

and ranges from a low-density executive setup to a high-density (up to 12-passenger) arrangement. The passenger seats can move forward and aft up to seven inches, track laterally up to 3.6 inches, and swivel 180 degrees. The seat backs can incline in any position from vertical to horizontal. The cabin includes thirteen elliptical windows with electric shades. Each seat has an individual air outlet and reading light [17]. The temperature can be controlled either from the cockpit or by a designated passenger [18].

The most common arrangement, shown in Figure 21, accommodates eight passengers in double club seating, with a forward starboard galley and a forward port closet. This layout includes four tables. The cabin includes up to four 110 Volt AC outlets and a lavatory with a belted flushing toilet [17].

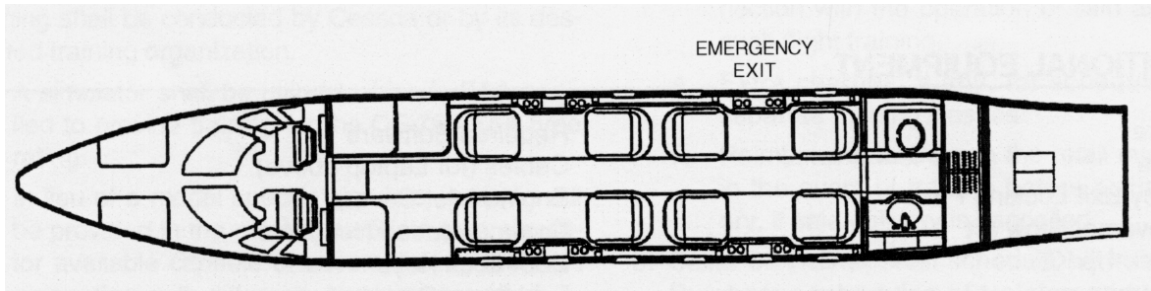

Figure 21: Typical Cabin Arrangement, from [20]

The cabin volume, choice of cabin arrangement, and perceived luxury of the cabin arrangement are important criteria when a customer is selecting a business jet. These needs drove the cabin design. The tradeoffs for increased cabin room are more drag and higher weight, leading to higher operating costs.

Baggage Compartment

The 72-cubic-foot baggage compartment can hold up to 700 pounds of cargo. It is pressurized and prevented from freezing by circulating cabin air into it. It can be isolated from the cabin in case of a fire or a leak but does not have its own fire suppression system [18]. A pressurized baggage compartment was considered a customer need from the outset of the program.

The access door is on the port side of the fuselage [17] and has an inflatable door seal [18]. The engine controllers, data acquisition units, and some circuit breakers are in the baggage compartment [18].

Tailcone

The unpressurized tailcone compartment can be accessed by a door on the bottom of the fuselage. The tailcone contains the engine fire-extinguishing bottles, the pressurization and air-conditioning units, and some ducting for the pneumatic and environmental systems [18]. It also contains the utility cargo area: a 10 cubic foot, 83-inch long compartment [17] that can contain up to 75 pounds of cargo [18] and is specifically designed to hold skis [17]. This cargo area also contains the auxiliary power unit [18].

Wings

The wings of the Citation X are highly swept: 40 degrees at the leading edge [18] and 37 degrees at the quarter chord [1]. It has 2 degrees of dihedral. Cessna custom-designed a supercritical airfoil with Boeing's help using proprietary Boeing software [19]. The root airfoil section is the Cessna 7500 and the tip is a Cessna 7504 [21]. The wing includes ailerons, speed brakes, and spoilers. There is a large fairing at the wing-fuselage interface in order to minimize drag [17]. The large sweep was driven by the requirement of Mach 0.9 flight. The airfoil shape was driven by the requirement to minimize drag, which in turn minimizes fuel burn. A lower fuel burn leads to both a higher range and to lower direct operating costs. In particular, the design was aimed towards delaying the Mach drag rise and controlling the shock waves [3].

The structure of the wing is of the stressed-skin type, that is, the skin supports some of the load. The skin is therefore machined out of plate aluminum rather than formed from sheet. The skin is "shotpeened" into shape: tiny shot pounds the metal against a form. The spars are riveted to the skin in four subassemblies, which are then joined into a single wing unit [19]. The need for maximum cabin volume drove the decision for the wing to be all one piece, rather than in two pieces as in previous Citation aircraft.

Empennage

The empennage is arranged in a T-tail configuration. The T-tail was chosen in order to place the horizontal tail out of the wake of the wings. It also has less interference drag than a cruciform tail. Cessna has had success with this configuration on previous Citations. Because the horizontal stabilizer is slightly farther aft than it would be on a

cruciform tail, it can be smaller and lighter, counteracting the additional structural weight required to use the vertical tail as the load path for the forces on the horizontal tail. Both the vertical and horizontal stabilizers are highly swept, as required for the high Mach number flight. The horizontal stabilizer has a high aspect ratio to minimize drag and has no dihedral. It is movable for trim. The elevator and rudder are described in Section 6.3.12.

6.3.2. Engines

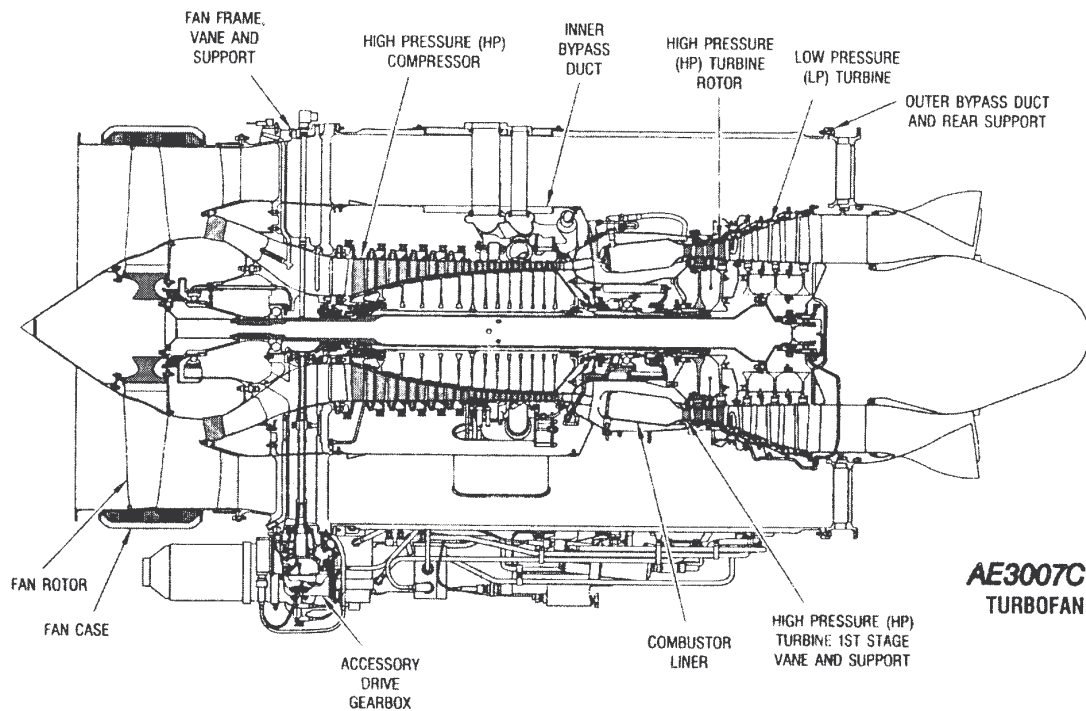

Figure 22: AE3007C Engine

The Citation X is powered by two Rolls-Royce Allison AE3007C turbopfans mounted on the rear fuselage. This engine, shown in Figure 22, has two spools, a 14-stage axial flow compressor, a two-stage high-pressure turbine, and a three-stage low-pressure turbine. The first five stages of the compressor have variable geometry. The engine has a modular design with six large access panels for line replacement unit maintenance and borescope inspection ports. It has a five to one bypass ratio. The static sea level thrust is 6764lbs at 86 degrees Fahrenheit ambient temperature [17]. The thrust-

specific fuel consumption is 0.36. The engine case is reinforced with Kevlar to meet FAA regulations specifying “burst containment” when one blade is lost.

The engines include electrically-controlled hydraulically-operated target-type thrust reversers manufactured by Dee Howard. As shown in Figure 23, the thrust reversers consist of doors that normally make up the aft-most section of the engine’s exhaust outlet. When deployed, the clamshell doors pivot to block the normal exhaust path, diverting the exhaust gases forward. Each thrust reverser is operated by two actuators on one hydraulic system. They cannot be actuated when there is no weight on the wheels [18].

The thrust reversers are not required to be functional in order to operate the airplane [21]. They cannot be included when calculating the required landing field length. Cessna included thrust reversers because they found their customers preferred the convenience of a faster deceleration [32].

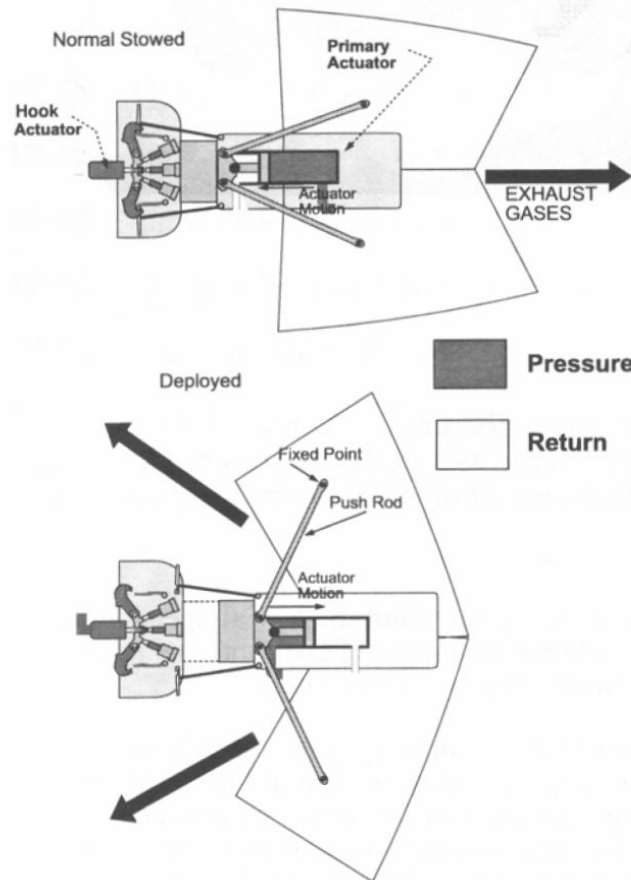

Figure 23: Thrust Reverser Operation

Each engine is controlled by a full authority digital engine controller (FADEC). This computer controls the fuel levels entering the engines to achieve a fan speed that corresponds to the requested thrust. It limits the rate of change of fuel flow to prevent surge during acceleration or lean blow out during a rapid deceleration. It also limits fuel flow to prevent the rotor speeds from exceeding their limits and from the temperature getting too high. If the rotor speeds do exceed their limits, it initiates an engine shutdown. The FADEC attempts an automatic re-light if it detects an engine flameout. For reasons explained below, it increases the fuel flow to compromise for reduced thrust in the case of fan damage. It is dual-channel and has no mechanical cables. The FADECs take inputs from the micro air data computer, the integrated avionics computer, and engine, cockpit, and aircraft sensors. They are not reliant on main aircraft electrical power. Each engine has a backup controller which is kept running as a “hot” spare. The FADECs are housed under the flooring in the baggage compartment [18].

The Citation X is the first aircraft to use this engine in this form. The engine was chosen in the summer of 1990, shortly before the announcement of the program. Cessna believed it might be somewhat bigger than was required but wanted to ensure that it provided adequate power for Mach 0.9 cruise. Another reason for choosing it was that its core was proven in the V-22. Embraer was supposed to use the engine first, and certify it, which would have been a cost savings for Cessna. Unfortunately for Cessna, Embraer had a delayed certification and Cessna became responsible for certifying the engine for the first time. The engine core, but not the fan, is used in the T406-AD-400 engine, which is used on the Boeing/Bell V-22 Osprey tiltrotor. The development of the engine was just slightly ahead of the development of the airframe. During the development of the engine, Rolls Royce had some difficulty meeting the bird-strike criteria. Specifically, the regulations state that after a bird strike causing fan damage, the thrust can decrease by at most 10%. The engine was not meeting this criterion. The implemented solution is that the FADEC responds to fan damage by increasing the fuel flow to compensate for the reduced thrust [3].

Another difficulty discovered during flight-testing was that at high altitudes and high angles of attack, the airframe was blocking airflow into the engine inlets. This was

causing the engines to flame out. The correction was to install an angle of attack warning system as described in Section 6.3.11.

As mentioned above, the Rolls-Royce AE 3007C engine is also used in some Embraer regional jets. This has been an advantage for the Citation X because Rolls Royce has been continuously improving the engine, for example, increasing the available thrust. This allowed the upgraded Citation Xs to have a shorter takeoff distance.

The oil system is shown in Figure 24 and includes an oil reservoir, an engine-driven pump, filters, a filter-bypass system, oil coolers, oil pressure and temperature sensors, a low oil pressure switch, and a chip detection and collection system. The normal range for the oil pressure is between 34 and 90 psi. The oil is cooled using both air and fuel [18].

The ignition system is fully redundant and is controlled by the FADECs. Normally only one igniter is used, alternating between the two systems. During air starts and automatic ignition sequences, both igniters are used.

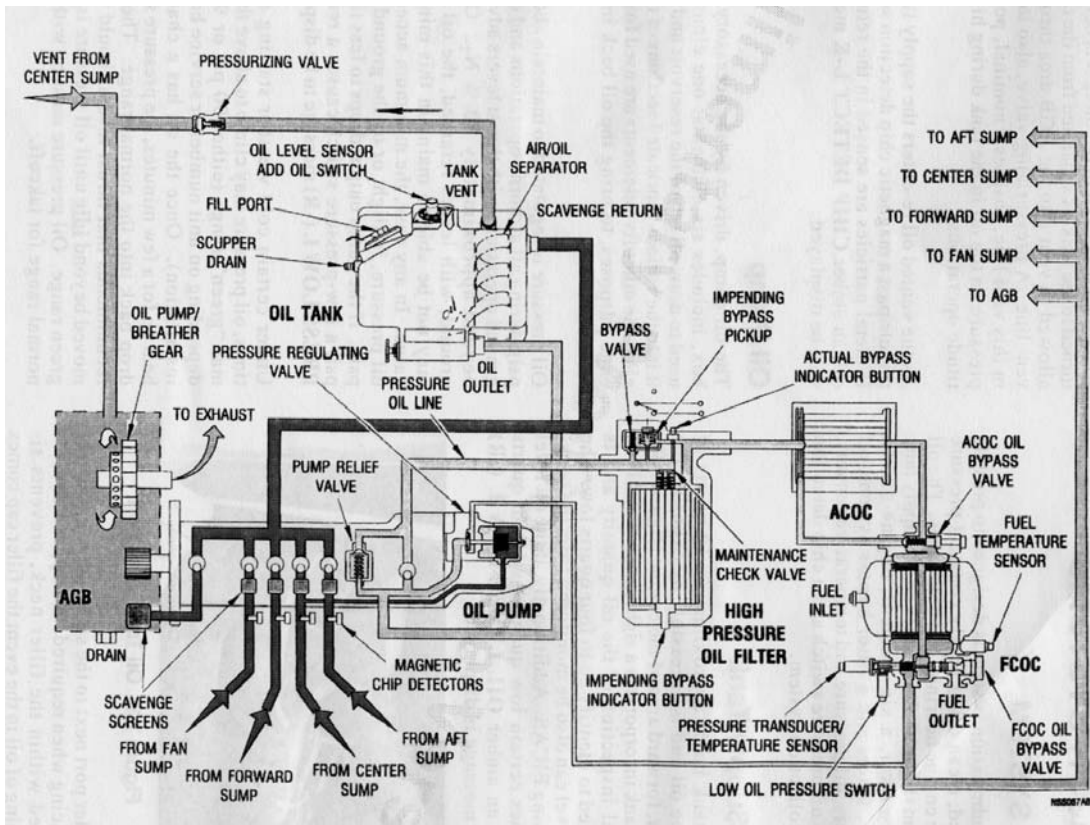

Figure 24: Oil System

The engines require air pressure to start. This pressure can be supplied by: 1) the other engine, 2) the auxiliary power unit (described in the electrical section, below), 3) an external air cart, or 4) a “buddy” aircraft [18].

The engines supply bleed air from their 8th and 14th stages to the anti-icing and environmental systems. Bleed air from the 10th stage cools the aft sections of the rotor shaft, cools critical sections of the turbine, and buffers various carbon seals. The high-pressure shaft of each engine drives an accessory gearbox. The accessory gearbox drives the oil pump, main fuel pump, hydraulic pump, motive fuel pump, DC generator, AC generator, permanent magnet alternator, and the engine starter motor [18].

The high altitude and 0.9 Mach number requirements were significant drivers for the engine performance. Other important requirements to the engine design were low noise, fail-safe systems, maintainability, and many regulatory requirements.

6.3.3. Fuel system

The Citation X can hold up to 13000 lbs of usable fuel in three fuel tanks: 3500 lbs in each wing and 6000 lbs in a center tank, located in the center portion of the wing and the forward fairing. The fuel capacity was driven by the range requirement. The center tank does not feed the engines directly; rather, center tank fuel is transferred into the wing tanks using two scavenge ejector pumps in the center tanks [17]. The wing tanks then transfer the fuel from their lowest points into two engine feed bay “hoppers.” The left hopper tank also supplies the auxiliary power unit (APU). The hoppers are surrounded by the aft portion of the center fuel tank. They contain electric and motive fuel pumps to provide positive pressure to the fuel pump and metering unit, which is controlled by the digital engine controller and feeds the engines. [18] Figure 25 is a schematic of the fuel system.

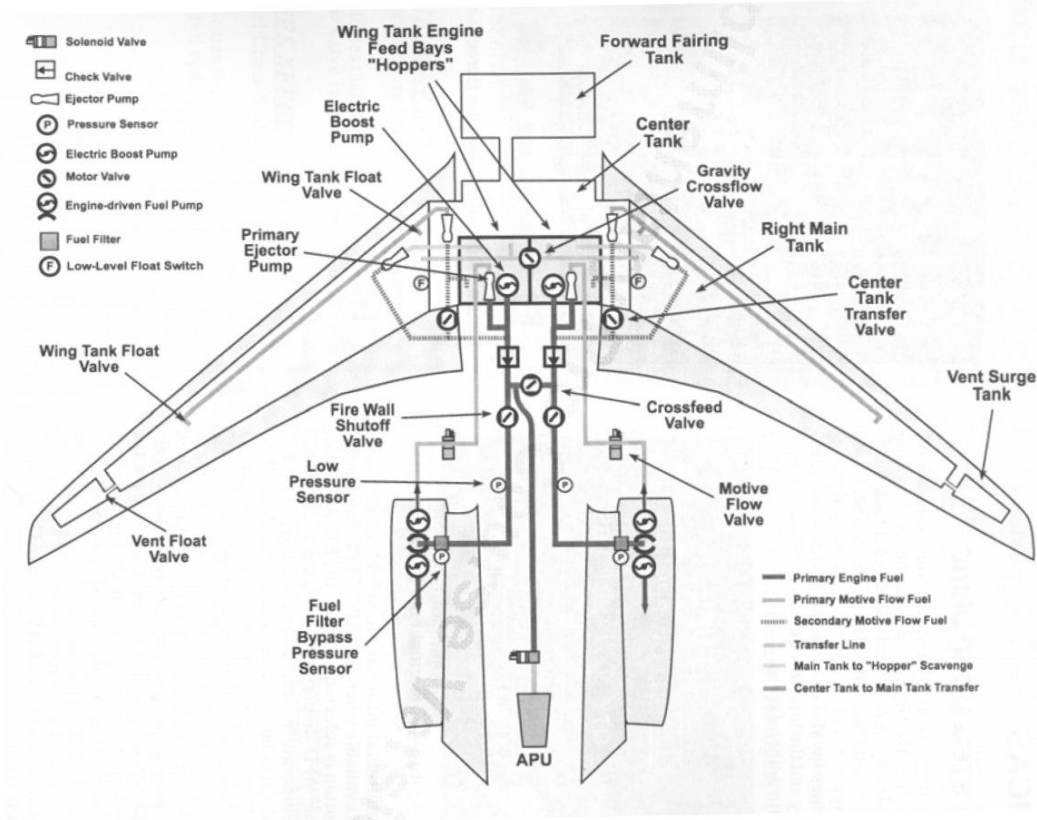

Figure 25: Fuel System Schematic

Gravity crossflow corrects any fuel imbalances between the two wing tanks. The wings are automatically filled from the center tank as the wing fuel volume decreases. There is also engine crossfeed, allowing both engines to be fed from either tank. One-way flapper valves are installed in the wing tank to dampen fuel movement during turns, by preventing fuel flow from the wing root to the outboard section of the wing. Gravity flow from the wing tip to the root is restricted but not stopped [18].

The airplane can be single-point-pressure refueled from a point under the port wing or over-wing refueled from above both wings. [17]

There is no dedicated fuel heater. Instead, the fuel used to cool the oil system is heated enough in the oil-cooling heat exchanger to prevent ice crystal formation [18].

The Citation X uses Jet A fuel and usually burns approximately 2500lbs in its first hour of flight and 1800-2200 lbs per hour after that, depending on payload and speed [18].

6.3.4. Avionics

The fully integrated digital avionics package is supplied by Honeywell. It consists of a combination autopilot/flight director/engine indicating and crew alerting system (EICAS), a flight management system, an airborne flight information system, a weather radar, a traffic alert and collision avoidance system, a ground proximity warning system, a cockpit voice recorder, a radio altimeter, navigation and communication radios, a high-frequency communication system, the audio system, an angle-of-attack indicator, and an emergency locator transmitter. There are also backup instruments with their own battery. The system logic of the Honeywell Primus system is shown in Figure 26.

The major design drivers for the avionics are ease of piloting, reliability, a shallow learning curve for the pilots, and the impression for the owners that they are buying the best technology.

The Citation X was the first Cessna airplane to use integrated avionics, that is, avionics that monitor the entire aircraft. Originally, the Honeywell Primus system was to be certified in a Gulfstream aircraft before the Citation X was certified. However, the Gulfstream certification was delayed and the Citation X was the first aircraft to be certified with these avionics.

Autopilot/Flight Director/EICAS

The Honeywell Primus 2000 is an autopilot, flight director, and engine indicating and crew alerting system (EICAS). It has five LCD display screens: a primary flight display and a multi-function display for each of the pilot and co-pilot and a shared center screen. The primary flight display indicates attitude, heading, air data, flight director data, and navigation data. The multi-function display shows the heading, navigation aids, airport data, flight plans, radar, flight management system vertical navigation data, checklists, engine indications, control surface positions, and crew alerting system messages [17]. The messages come in four different colors, in order of decreasing importance: red, amber, cyan (light greenish-blue), and white. A voice or aural chime sometimes accompanies these messages [18]. This screen also provides a backup screen for the primary flight display. The center screen provides engine indications, announcements, and systems information [17].

The EICAS was one of the most difficult systems integration challenges for the Citation X team. Because it monitors every subsystem, there were a large number of interfaces to be managed.

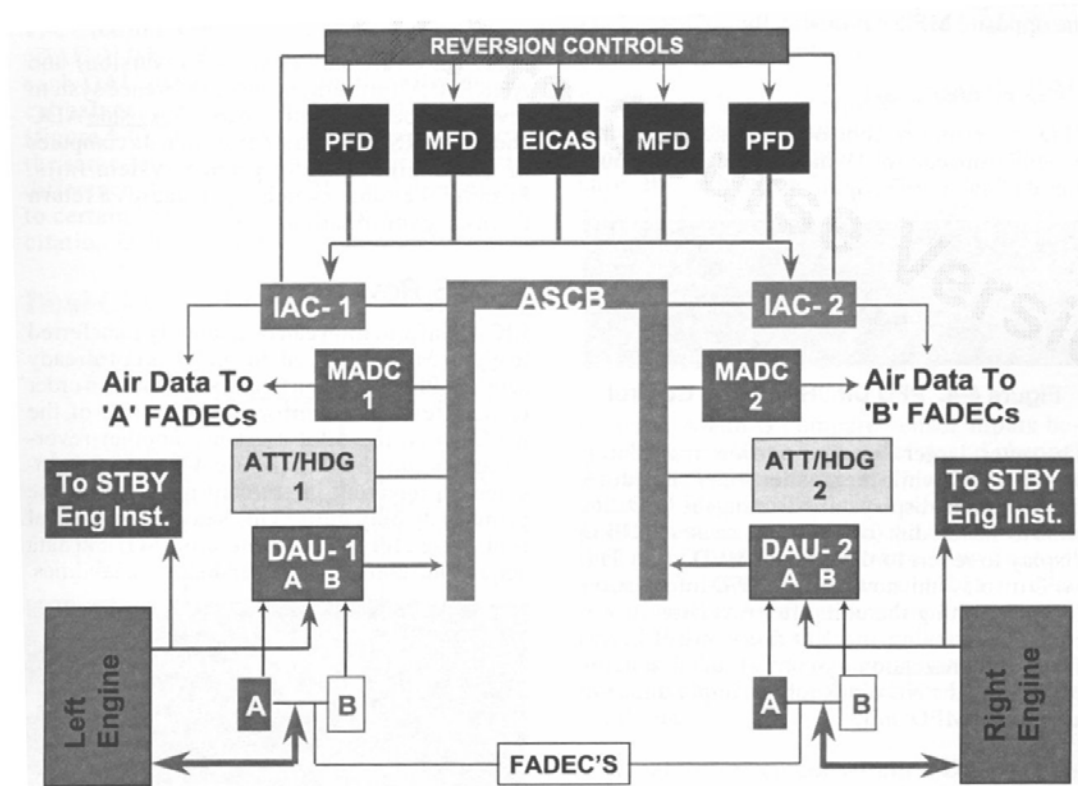

Figure 26: Honeywell Primus System Logic

The cockpit display units have color display and an alphanumeric computer. They take input from GPS sensor units and have a data loader to update the database [17]. Two AZ-840 micro air data computers provide air data information to the system [17].

Flight Management System

The flight management system provides full flight regime lateral and vertical navigation management and engine trend monitoring. It has a worldwide database of navigation data [17].

Airborne Flight Information System

The airborne flight information system is a very high frequency (VHF) ground-based two-way data link that provides flight-planning information, weather services, air