

MIT OpenCourseWare
<http://ocw.mit.edu>

2.500 Desalination and Water Purification

Spring 2009

For information about citing these materials or our Terms of Use, visit: <http://ocw.mit.edu/terms>.

SAND REPORT

SAND 2003-0800
Unlimited Release
Printed March 2003

Review of Water Resources and Desalination Technologies

James E. Miller

Prepared by
Sandia National Laboratories
Albuquerque, New Mexico 87185 and Livermore, California 94550

Sandia is a multiprogram laboratory operated by Sandia Corporation,
a Lockheed Martin Company, for the United States Department of Energy's
National Nuclear Security Administration under Contract DE-AC04-94-AL85000.

Approved for public release; further dissemination unlimited.



Sandia National Laboratories

Issued by Sandia National Laboratories, operated for the United States Department of Energy by Sandia Corporation.

NOTICE: This report was prepared as an account of work sponsored by an agency of the United States Government. Neither the United States Government, nor any agency thereof, nor any of their employees, nor any of their contractors, subcontractors, or their employees, make any warranty, express or implied, or assume any legal liability or responsibility for the accuracy, completeness, or usefulness of any information, apparatus, product, or process disclosed, or represent that its use would not infringe privately owned rights. Reference herein to any specific commercial product, process, or service by trade name, trademark, manufacturer, or otherwise, does not necessarily constitute or imply its endorsement, recommendation, or favoring by the United States Government, any agency thereof, or any of their contractors or subcontractors. The views and opinions expressed herein do not necessarily state or reflect those of the United States Government, any agency thereof, or any of their contractors.

Printed in the United States of America. This report has been reproduced directly from the best available copy.

Available to DOE and DOE contractors from
U.S. Department of Energy
Office of Scientific and Technical Information
P.O. Box 62
Oak Ridge, TN 37831

Telephone: (865)576-8401
Facsimile: (865)576-5728
E-Mail: reports@adonis.osti.gov
Online ordering: <http://www.doe.gov/bridge>

Available to the public from
U.S. Department of Commerce
National Technical Information Service
5285 Port Royal Rd
Springfield, VA 22161

Telephone: (800)553-6847
Facsimile: (703)605-6900
E-Mail: orders@ntis.fedworld.gov
Online order: <http://www.ntis.gov/help/ordermethods.asp?loc=7-4-0#online>



SAND 2003-0800
Unlimited Release
Printed March 2003

Review of Water Resources and Desalination Technologies

James E. Miller
Materials Chemistry Department
Sandia National Laboratories
P.O. Box 5800
Albuquerque, NM 87185-1349

Abstract

Water shortages affect 88 developing countries that are home to half of the world's population. In these places, 80-90% of all diseases and 30% of all deaths result from poor water quality. Furthermore, over the next 25 years, the number of people affected by severe water shortages is expected to increase fourfold. Low cost methods to desalinate brackish water and sea water can help reverse this destabilizing trend.

Desalination has now been practiced on a large scale for more than 50 years. During this time continual improvements have been made, and the major technologies are now remarkably efficient, reliable, and inexpensive. For many years, thermal technologies were the only viable option, and multi-stage flash (MSF) was established as the baseline technology. Multi-effect evaporation (MEE) is now the state-of-the-art thermal technology, but has not been widely implemented. With the growth of membrane science, reverse osmosis (RO) overtook MSF as the leading desalination technology, and should be considered the baseline technology. Presently, RO of seawater can be accomplished with an energy expenditure in the range of 11-60 kJ/kg at a cost of \$2 to \$4 per 1000 gallons. The theoretical minimum energy expenditure is 3-7 kJ/kg.

Since RO is a fairly mature technology, further improvements are likely to be incremental in nature, unless design improvements allow major savings in capital costs. Therefore, the best hope to dramatically decrease desalination costs is to develop "out of the box" technologies. These "out of the box" approaches must offer a significant advantage over RO (or MEE, if waste heat is available) if they are to be viable. When making these comparisons, it is crucial that the specifics of the calculation are understood so that the comparison is made on a fair and equivalent basis.

Table of Contents

TABLE OF CONTENTS.....	4
WATER FACTS	6
WATER RESOURCES – THE BIG PICTURE	6
WATER RESOURCES – DISTRIBUTION AND AVAILABILITY	8
FACTORS INFLUENCING WATER USAGE.....	10
WATER USE IN THE UNITED STATES	11
WATER RESOURCES – A ROLE FOR DESALINATION?	12
DESALINATION BASICS	14
GENERAL DESIGN CONSIDERATIONS AND LIMITATIONS.....	14
THREE BASIC APPROACHES TO DESALINATION.....	16
MAJOR COMMERCIAL PROCESSES	17
DISTILLATION PROCESSES.....	17
<i>Multi-stage Flash</i>	17
<i>Multi-effect Evaporation</i>	18
<i>Vapor Compression (Thermal and Mechanical)</i>	19
MEMBRANE PROCESSES	20
<i>Reverse Osmosis</i>	20
<i>Electrodialysis</i>	21
PUTTING THINGS IN PERSPECTIVE - ENERGY REQUIREMENTS	22
PUTTING THINGS IN PERSPECTIVE - DESALINATION COSTS	24
<i>Reported Costs for Desalination</i>	24
<i>Major Cost Components of Desalination</i>	26
<i>Other Cost Considerations</i>	29
WORLD-WIDE DESALINATION CAPACITY	29
MAJOR SUPPLIERS OF DESALINATION EQUIPMENT AND TECHNOLOGY	30
FINANCING DESALINATION	31
CONCLUSIONS.....	32
ALTERNATE PROCESSES	32
CRYSTALLIZATION PROCESSES.....	32
<i>Freeze desalination</i>	32
<i>Gas Hydrate processes</i>	34
HUMIDIFICATION PROCESSES.....	34
<i>Dewvaporation process</i>	35
<i>Seawater Greenhouse</i>	36
<i>Membrane Distillation</i>	36
<i>Mechanically Intensified Evaporation</i>	36
<i>Atmospheric Water Vapor Processes</i>	37
DEEP OCEAN AND WAVE DRIVEN PROCESSES	37
<i>Osmotic Pump</i>	38
<i>Deep Ocean Hydrostatic Head</i>	38
<i>Wave Pumps</i>	39
<i>Waterhammer</i>	39
<i>Nodding Duck</i>	39
SOLAR PROCESSES.....	40
<i>Solar Stills</i>	40
OTHER PROCESSES	41
<i>Ion Exchange</i>	41

<i>Flow Through Capacitor</i>	42
<i>Liquid-liquid Extraction</i>	43
<i>Centrifugal RO</i>	43
<i>Rotary Vapor Compression</i>	44
CHALLENGES AND OPPORTUNITIES	44
THERMAL PROCESSES	44
PHYSICAL PROCESSES	47
CHEMICAL PROCESSES	48
GENERAL ISSUES	49
REFERENCES	49

Water Facts

Water is the basic substance of life on earth, and it is increasingly in short supply. Water shortages affect 88 developing countries that are home to half of the world's population. In these places, 80-90% of all diseases and 30% of all deaths result from poor water quality [1]. Furthermore, over the next 25 years, the number of people affected by severe water shortages is expected to increase fourfold [2]. Some of this increase is related to population growth, some is related to the demands of industrialization. Currently, water consumption doubles every 20 years, about twice the rate of population growth [3]. Governments throughout the world are beginning to take notice of the looming crisis. There is recognition that future peace and prosperity is intimately tied to the availability of clean, fresh water, and a growing consensus that future wars will probably be fought over water. In fact in recent days, Israel has threatened war with Lebanon over the diversion of water from the Wazzani River whose flows eventually reach the Sea of Galilee [4].

Corporate interests have also taken note of the situation. Global corporations are buying and selling water rights at an unprecedented rate leading *Fortune* magazine to comment that "Water promises to be to the 21st century what oil was to the 20th century: the precious commodity that determines the wealth of nations" [5]. In California, a relatively dry state, the buying and selling of water rights is such that Governor Gray Davis has stated "Water is more precious than gold" [3].

In the late 19th century, Western Europe's growth, prosperity, and indeed dominance, was threatened by the fact that it had reached the limits of the land's possibility to feed it's people. Stagnation and collapse was averted when Fritz Haber invented a chemical process for creating ammonia fertilizer [6]. The world may now be reaching a similar turning point. In addition to conservation measure, new and low cost methods of purifying freshwater, and desalting seawater, are required to contend with the destabilizing threat of running out of water. With that in mind, the purpose of this document is to provide a broad overview of the current status of desalination technologies, thereby establishing a baseline to which new technologies must be compared. To provide a context for the review, a brief overview of water resources is provided. Competing demands for water resources and control and ownership of water resources, focusing on the United States, are also briefly discussed.

Water Resources – The Big Picture

There is an almost unfathomable amount of water on earth: about 1.4 billion km³ (330 million cubic miles) [3]. Of this total, less than 3% is fresh water (about 35,000,000 km³), much of which (about 24,000,000 km³) is inaccessible due to the fact that it is frozen in ice caps and glaciers (Figure 1). It is estimated that just 0.77% (about 11,000,000 km³) of all the earth's water is held as groundwater, surface water (in lakes, swamps, rivers, etc.) and in plants and the atmosphere [7]. Similar to fossil energy

resources, almost all of this water has slowly accumulated over time and cannot be considered to be renewable.

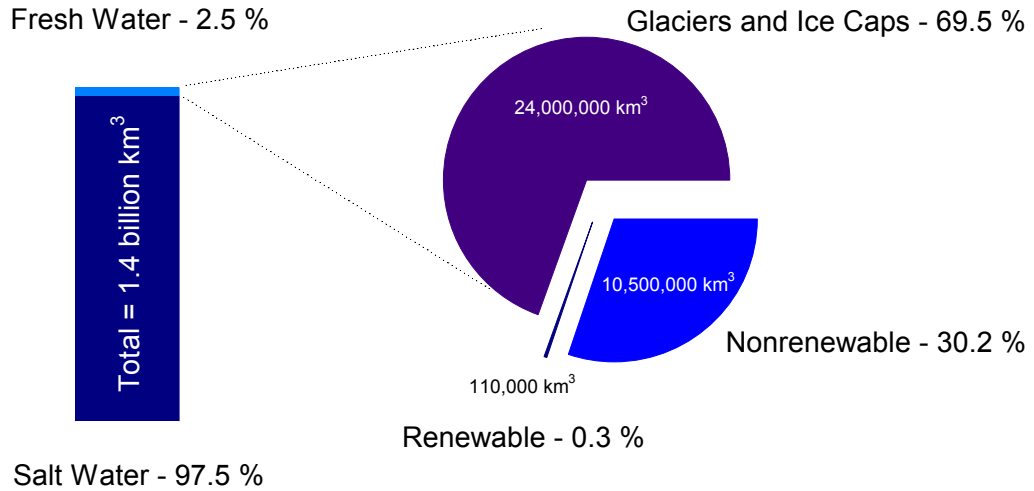

Figure 1. Distribution of the world's water. Adapted from [7].

The global water cycle accounts for the only naturally renewable source of fresh water, that is, precipitation that occurs over land (about 110,300 km³/year). Figure 2 is a simplified illustration of the global hydrological cycle.

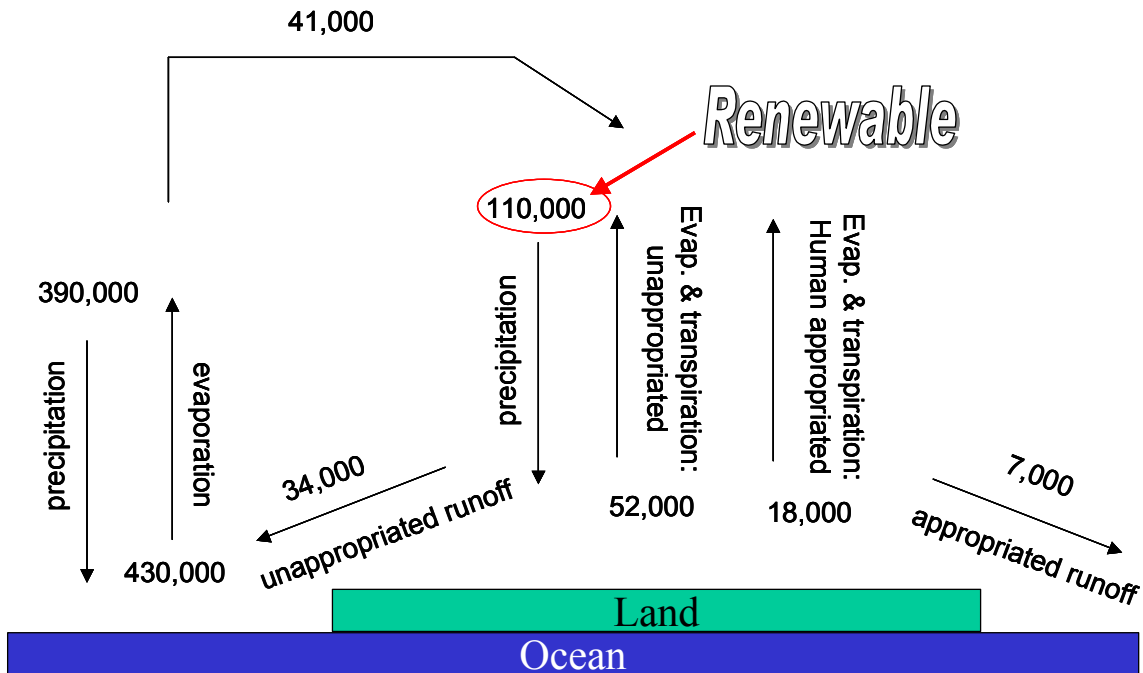

Figure 2. The global water cycle with estimates of flows and human appropriation. Units are km³/year. Adapted from [8].

Of the precipitation occurring over land, a large fraction (69,600 km³/year) is recycled to the atmosphere through evaporation and transpiration from plants. About 26% of this part of the cycle (18,200 km³/year) is appropriated for human use, e.g. through agriculture. The remaining water (runoff) is that which is directly available for other forms of human appropriation. Worldwide, the total annual runoff (including soil infiltration and groundwater replenishment) is estimated to be 40,700 km³/year [8]. Accounting for geographical remoteness and seasonal issues (e.g. flooding) that limit the accessibility of water, the total annual accessible runoff is only about 12,500 km³/year. Therefore, it is estimated that about 54% of the accessible runoff and 23% of the total renewable resource (precipitation occurring over land) is currently appropriated for human use in some form [8]. Of course, the resource needs to be able to support both human populations and the rest of the natural environment.

Water Resources – Distribution and Availability

Fresh water is not evenly distributed across the world. The availability of freshwater varies by geographical region, and with the seasons. The renewable fraction of the earth's freshwater is usually found in the form of surface water (rivers, lakes, streams, etc.) and is very unevenly distributed. As an example, consider that only 4% of the U.S. land mass is covered by rivers, lakes, and streams. It is this uneven distribution over both time and geography that accounts for the fact that only about 30% of the world's annual freshwater runoff is considered to be accessible for human exploitation. It also this uneven distribution that results in almost all water issues arising on a regional basis.

From the standpoint of long term sustainability, it is the renewable resource that is most critical. Table 1 provides an overview of those countries currently experiencing water scarcity or water stress, as well as projections for the year 2025. The estimates of the renewable resource used for Table 1 were taken from *World Resources*, a publication of the World Resources Institute in cooperation with the World Bank and the United Nations, and from the Organization for Economic Cooperation and Development (OECD) Environmental Data Compendium (1999). The population data, along with the high, medium, and low estimates for the year 2025 were taken from United Nations Populations Division's *World Population Prospects: The 2000 Revision*. The data was compiled by Population Action International [11].

The benchmarks used for water stress and water scarcity in Table 1 were developed by Malin Falkenmark, a Swedish hydrologist, and have been generally accepted by organizations such as the World Bank [9]. A moderately developed country with more than 1,700 m³/capita-year (1200 gal/person-day) of renewable fresh water (water stress) will generally experience only intermittent or localized water shortages. Below this level, problems tend to become chronic and widespread. When water availability falls below 1,000 m³/capita-year (water scarcity), the resulting water shortages can interfere with economic development and lead to environmental degradation [10]. These are rough benchmarks, and there are exceptions. For example, some would say that Israel has done well with only 464 m³/capita-year (Table 1), although they are experiencing problems

Table 1. Distribution of renewable fresh water resources on a per capita basis [11]. Blue shading indicates water scarcity, green shading indicates water stress.

Country	Renewable Water (m ³ /year)				
	Total (km ³ /yr)	Per capita (2000)	Per capita (2025 low)	Per capita (2025 med.)	Per capita (2025 high)
Kuwait	0	0	0	0	0
United Arab Emirates	0	77	61	58	55
Saudi Arabia	2	118	63	59	56
Jordan	1	142	87	81	76
Libyan Arab Jamahiriya	1	151	107	100	95
Yemen	4	223	89	85	82
Oman	1	394	196	185	177
Tunisia	4	412	348	316	291
Israel	3	464	354	330	310
Algeria	14	472	361	335	313
Burundi	4	566	303	291	281
Rwanda	6	828	509	489	471
Kenya	30	985	739	673	624
Morocco	30	1004	779	714	665
Egypt	69	1009	789	723	666
Denmark	6	1116	1133	1107	1083
Zimbabwe	14	1117	820	755	700
South Africa	50	1154	1251	1142	1052
Lebanon	5	1373	1117	1048	992
Haiti	12	1486	1114	1048	989
Korea, Rep	70	1493	1378	1341	1307
Czech Republic	16	1558	1675	1645	1617
Belgium	16	1561	1602	1568	1535
Poland	63	1632	1728	1691	1656
Malawi	19	1645	1022	952	907
Burkina Faso	20	1690	808	773	745
Ethiopia	110	1749	1020	970	932
Somalia	16	1789	778	741	714
Pakistan	255	1805	1063	1016	973
Iran (Islamic Republic of)	129	1827	1400	1293	1206
India	1908	1891	1511	1411	1323
Germany	178	2170	2299	2256	2215
China - all included	2830	2206	2028	1912	1823
Bulgaria	18	2290	3027	2971	2917
Eritrea	9	2405	1302	1246	1196
Nigeria	280	2459	1454	1380	1312
United Kingdom	147	2474	2456	2400	2346
Dominican Republic	21	2508	2057	1922	1805
Tanzania	89	2534	1592	1474	1377
Lesotho	5	2556	2486	2337	2203
Sri Lanka	50	2642	2370	2219	2084
Togo	12	2651	1524	1460	1402
Moldova, Republic of	12	2724	3010	2887	2776
Ghana	53	2756	1852	1720	1609
Syrian Arab Republic	45	2761	1754	1631	1524
Armenia	11	2799	2916	2837	2791
Spain	112	2809	3049	2998	2950
Ukraine	140	2816	3603	3528	3458
El Salvador	18	2819	2120	1972	1842
Uganda	66	2833	1294	1228	1179
France	170	2870	2783	2709	2642
Afghanistan	65	2986	1507	1438	1382
Niger	33	3000	1326	1263	1216
United States	2478	8749	7439	7145	6775

such as salt incursion into some of their aquifers [13].

A quick examination of Table 1 reveals that the Middle East and North Africa are the most water scarce regions of the world. These areas are home to about 6.3% of the world's population, but receive only 1.4 % of the earth's renewable freshwater [12]. Population growth in these areas is expected to exacerbate the problem. In contrast to the Middle East, the United States has a relative abundance of renewable fresh water. However, there are areas of the country, especially in the West, where the resource is limited.

Groundwaters tend to be far more evenly distributed than surface waters, and the resource is vast (Figure 1). However, as previously indicated, much of this water is a non-renewable fossil resource that is subject to local depletion. The "safe yield" of an aquifer is that which can be withdrawn without ultimately depleting the aquifer, that is the portion of the water that is renewable. When more than this amount is withdrawn, the aquifer recedes and a number of undesirable effects can result. In addition to risk of completely draining an aquifer, there may be incursion of inferior water, e.g. brine, into the aquifer, or the land may sink (subsidence).

The Ogallala aquifer is often cited as an example of an important fossil water resource that is being rapidly depleted. This aquifer stretches from Southern South Dakota to Northwestern Texas and supplies as much as 30% of the groundwater used for irrigation in the United States. By 1990, 24% of the Texas portion of the aquifer had been depleted (164 billion m³), primarily to grow grain to feed to cattle. In recent years the rate of depletion has slowed, and is now only 88% of the depletion rate in the 1960s. About a third of this decrease can be traced to improved methods of irrigation, but two thirds are the result of a decrease in irrigated area that resulted at least in part from increased pumping costs [13].

Factors Influencing Water Usage

Aside from the natural availability, there are any number of other factors that determine water use in a particular region [14]. One of the obvious factors is the size of the local population. Two closely related factors are the type of community, e.g. agricultural, residential, or industrial, and the health and level of development of the economy. The wealth of a community influences attitudes and funding towards water development and treatment as well as environmental issues. Economics and wealth also affects the level of technology available to a community. The local climate plays a significant role due to influences on evaporation rates as well as practices such as lawn watering and cooling requirements. Cultural values may also have an impact. The actions, policies, and laws of local, regional, state and national governments all effect water use. For example, governments may adopt tax or pricing policies designed to favor agriculture or industrial water users, or they may undertake projects to enhance water supplies by diverting water from one region to another. They may also take actions that encourage (or unintentionally discourage) conservation. Finally, the issue of ownership of the resource can be a critical factor that inevitably is linked to government influences.

Water Use in the United States

Every 5 years the US geological survey publishes a report on water use in the United States. The most recent version was published in 1998, and estimated water use for the year 1995 [15]. The total withdrawal of water (both fresh and saline) for all offstream water uses was estimated to be 402,000 Mgal/day, a per capita use of about 1,500 gal/day. This is almost a 10% decrease from the peak estimate in 1980. Freshwater per capita usage was estimated to be 1,280 gal/day. The report differentiates consumptive use from uses which allow a return flow. Per capita consumptive use was estimated to be 375 gal/day. The approximately 339,000 Mgal/day of freshwater that was withdrawn represents about ¼ of the renewable supply. About 70% of this water was returned to stream flows after use [16].

The report details offstream water use by region, state and application. Offstream uses are categorized as public supply, domestic, commercial, irrigation, livestock, industrial, mining, and thermoelectric power. Hydroelectric power is recognized as an instream use, but minimum flow requirements for navigation or environmental considerations are not. Not surprisingly, the largest freshwater withdrawal (134,000 Mgal/day) and more than 80% of the total consumptive use (81,300 Mgal/day) is associated with irrigation. Irrigation overwhelmingly (about 90%) occurs in Western states. California, Idaho, Colorado, Texas, and Montana account for 54% of the irrigation withdrawals. As a consequence of this usage pattern, about 47% of freshwater withdrawals in the west result in consumptive use. Table 2 which details water usage by state verifies these patterns. Per capita usage is highest in arid western states with agricultural based economies.

Thermoelectric power cooling accounts for the second largest withdrawal of freshwater in the U.S. (132,000 Mgal/day). An additional 58,000 Mgal of saline water was also used for this purpose. The disposition of freshwater withdrawn for cooling power plants is overwhelming return flow (99.5%). Together agriculture and power generation account for almost 80% of the total freshwater withdrawals. Domestic and commercial uses of freshwater account for only about 12% of the total, while industry and mining account for remaining 8%.

Table 2. Per capita freshwater withdrawals and sources by state [15].

State	Population (1000s)	FW use (gal/capita-day)	Ground (Mgal/day)	Surface (Mgal/day)	Total (Mgal/day)	% grnd	% surf.
Wyoming	480	14700	317	6720	7037	4.5	95.5
Idaho	1163	13000	2830	12300	15130	18.7	81.3
Montana	870	10200	204	8640	8844	2.3	97.7
Nebraska	1637	6440	6200	4350	10550	58.8	41.2
Colorado	3747	3690	2260	11600	13860	16.3	83.7
Arkansas	2484	3530	5460	3310	8770	62.3	37.7
West Virginia	1828	2530	146	4470	4616	3.2	96.8
Oregon	3140	2520	1050	6860	7910	13.3	86.7
Louisiana	4342	2270	1350	8500	9850	13.7	86.3
Utah	1951	2200	776	3530	4306	18.0	82.0
New Mexico	1686	2080	1700	1800	3500	48.6	51.4
Kansas	2565	2040	3510	1720	5230	67.1	32.9
Tennessee	5256	1920	435	9640	10075	4.3	95.7
North Dakota	641	1750	122	1000	1122	10.9	89.1
South Carolina	3673	1690	322	5880	6202	5.2	94.8

Illinois	11830	1680	928	19000	19928	4.7	95.3
Alabama	4253	1670	436	6650	7086	6.2	93.8
Arizona	4218	1620	2830	3980	6810	41.6	58.4
Washington	5431	1620	1760	7060	8820	20.0	80.0
Indiana	5803	1570	709	8430	9139	7.8	92.2
Nevada	1530	1480	855	1400	2255	37.9	62.1
Wisconsin	5102	1420	759	6490	7249	10.5	89.5
Missouri	5324	1320	891	6140	7031	12.7	87.3
Texas	18724	1300	8370	16000	24370	34.3	65.7
Michigan	9549	1260	858	11200	12058	7.1	92.9
Kentucky	3860	1150	226	4190	4416	5.1	94.9
Mississippi	2697	1140	2590	502	3092	83.8	16.2
California	32063	1130	14500	21800	36300	39.9	60.1
Iowa	2842	1070	528	2510	3038	17.4	82.6
North Carolina	7195	1070	535	7200	7735	6.9	93.1
Delaware	717	1050	110	642	752	14.6	85.4
Vermont	585	967	50	515	565	8.8	91.2
Ohio	11151	944	905	9620	10525	8.6	91.4
Hawaii	1187	853	515	497	1012	50.9	49.1
Virginia	6618	826	358	5110	5468	6.5	93.5
Pennsylvania	12072	802	860	8820	9680	8.9	91.1
Georgia	7201	799	1190	4560	5750	20.7	79.3
Minnesota	4610	736	714	2680	3394	21.0	79.0
South Dakota	729	631	187	273	460	40.7	59.3
New York	18136	567	1010	9270	10280	9.8	90.2
Oklahoma	3278	543	959	822	1781	53.8	46.2
Florida	14116	509	4340	2880	7220	60.1	39.9
Connecticut	3275	389	166	1110	1276	13.0	87.0
New Hampshire	1148	388	81	364	445	18.2	81.8
Alaska	604	350	58	154	212	27.4	72.6
Maryland	5042	289	246	1210	1456	16.9	83.1
New Jersey	7945	269	580	1560	2140	27.1	72.9
Massachusetts	6074	189	351	795	1146	30.6	69.4
Maine	1241	178	80	141	221	36.2	63.8
Puerto Rico	3755	154	155	422	577	26.9	73.1
Rhode Island	990	138	27	109	136	19.9	80.1
Virgin Islands	103	113	0.5	11	12	4.3	95.7
D.C.	554	18	0.5	10	10	0.5	99.5
Total	267015	1280					

Water Resources – A role for desalination?

Increasingly, water scarcity will challenge human populations. Lack of water hinders economic development, devastates human health, leads to environmental degradation, and foments political instability. Parts of the Middle East and North Africa are already experiencing the effects that water shortages bring. A number of research agendas have been developed to address the water problem [17]. Ultimately, a number of parallel approaches will be necessary to limit the effects of water shortages including improving the efficiency of water use, implementing technologies and policies to encourage water conservation and reuse, slowing population growth, and tapping nontraditional sources of freshwater such as seawater, fog water, atmospheric water vapor, and water “produced” in conjunction with fossil energy or other resource recovery operations. Inland saline aquifers will likely be tapped and treated, and water will increasingly be “reclaimed” for use from waste treatment operations. As pointed out by De Villiers, in the absence of other strategies, people will be forced to deal with unplanned shortages, or to take action to trade for or “steal” water [18].

Within the different approaches, any number of specific measures and policies have been suggested. Typically these focus on efficiency and conservation, rather than “growing the supply.” For example, proposals for the Middle East include reallocating water away from agriculture towards domestic and industrial sectors, altering crop selections, installing efficient technologies such as drip irrigation, improving distribution efficiencies, educating the public about conservation measures, implementing economic penalties and incentives, instituting legal reforms, and slowing population growth [12]. Wolff and Gleick have suggested a “soft path” for water use that includes elements such as focusing on water needs, systems that deliver water of various qualities, and decentralized collection and distribution [19]. They specifically elaborate on the efficiency of use as a critical element to their approach. In her book *Last Oasis*, Postel has also pointed out the importance of improved irrigation techniques and localized systems. She also considers water recycling and urban conservation measures to be important factors for the future. She also advocates major systematic changes to achieve a more rationale valuation, allocation, and management of water resources.

From the perspective of growing the global supply, Postel et al. have noted that the most practical way of increasing the renewable water supply is to build new dams and reservoirs [8]. They estimate that this could increase the amount of accessible runoff by 10% over the next 30 years. Although they acknowledge a role for desalination, they predict that high costs will be limited to the production of domestic water in energy rich nations, and that it will have only a minor impact on the overall global water supply. In fact, this is the current situation for desalination. The total capacity of the more than 12,000 desalination plants in the world, overwhelmingly located in wealthy and energy rich nations, is equivalent to only 1.6% of the total daily freshwater usage in the United States alone. Furthermore, the production of potable water in the United States by membrane processes accounts for less than 0.5% of the total potable water delivered [20]. However, this analysis neglects the fact that on a local basis desalination can have an overwhelming impact. For example, Kuwait derives virtually its entire freshwater supply from desalination. Unfortunately, many at-risk developing nations do not possess the wealth or energy resources required to install and operate large desalination plants. Economic improvements will be necessary if desalination (or other schemes for harvesting water from nontraditional sources) is to have a similar impact in many other areas experiencing need.

Even without major advances, the United States is well positioned to benefit from desalination. By 1996, there were 180 desalination and membrane softening plants in the U.S., primarily reverse osmosis (RO) units treating brackish (slightly saline) water [20]. At that time the annual growth rate of brackish water RO capacity in the U.S. was about 18%, and the annual growth rate of brackish water electrodialysis capacity was 25%. However, seawater RO was (and is) not a significant factor in the water supply. Leitner reviewed the history and status of seawater desalination in the United States in 1995 and concluded that the stagnation (or even negative growth) resulted primarily from the fact that there was not yet a demonstrated need [21]. However, he noted that relatively cost effective technologies are available once that need is realized (costs are reviewed below).

Another factor that may be limiting the growth of desalination in the U.S. is a lack of knowledge and understanding about the current status of water supplies and the ability of desalination to address needs. In April, 2000, the U.S. Bureau of Reclamation sponsored a workshop entitled “Growing the U.S. Water Supply through Purification Technologies” to “begin a conversation and to develop a consensus on ways to more actively promote new water purification technologies among representatives of water users” [22]. Education about water supplies and available technologies were commonly cited as needs. The need for a national water policy related to purification technologies was also identified, as was the need to fund research and demonstration of water purification technologies.

In conclusion, countering current and impending water shortages will require the implementation of any number of conservation and efficiency measures. From the global perspective, desalination will have only a small impact on the fresh water supply. However, on a local basis, desalination (coupled with other measures) will play a pivotal role. Wealthy nations will be able to capitalize on desalination as necessary, using currently available technology. Improvements in the economics are required before desalination will be widely implemented in the developing world.

Desalination Basics

General design considerations and limitations

The theoretical minimum energy for desalination of seawater, with an incremental recovery of freshwater, is a little less than 3kJ/kg water [24]. Although this value can be arrived at in a number of ways, it is perhaps easiest to think of the minimum requirement as the free energy change associated with the process of salt dissolution. This energy change is linked to any number of physical phenomena, including boiling point elevation, freezing point depression, and osmotic potential (or pressure). Assuming a process where fresh water is recovered from a salt solution (as opposed to recovering the salt from the water), it is clear that as the recovery of freshwater is increased, the remaining solution becomes ever more concentrated, thereby further elevating the boiling point, etc. Thus, as the recovery increases, the energy required to perform the operation must also increase. The relationship between recovery and the theoretical minimum energy requirement is shown in Figure 3.

As a practical matter, we know that desalination processes (or any process for that matter) can not operate with perfect efficiency. Furthermore, design considerations teach us that systems operating with nearly perfect energy efficiency (near thermodynamic reversibility) will be large in size, and will therefore have high capital costs. Conversely, processes that use energy less efficiently can be smaller and will thus tend to have lower capital costs. Thus, for most practical applications, there is a tradeoff between capital costs and energy costs that leads to an optimum plant design and minimum product water cost. Spiegler and El-Sayed have recently published reviews of this concept [23]. In short, the best process design is not necessarily the most energy efficient design (Figure

4). Keep in mind that for special applications, other design parameters, e.g. size and weight, may also need to be considered.

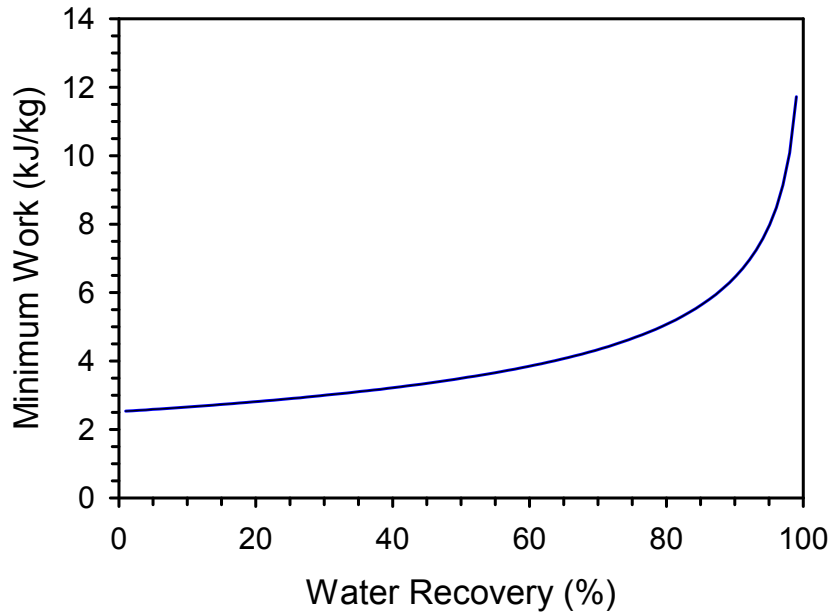

Figure 3. The theoretical minimum energy for desalting seawater as a function of freshwater recovery. Derivation from [24]. Calculation assumes infinite solubility of salt in water – precipitation of NaCl salt begins at about 90% recovery.

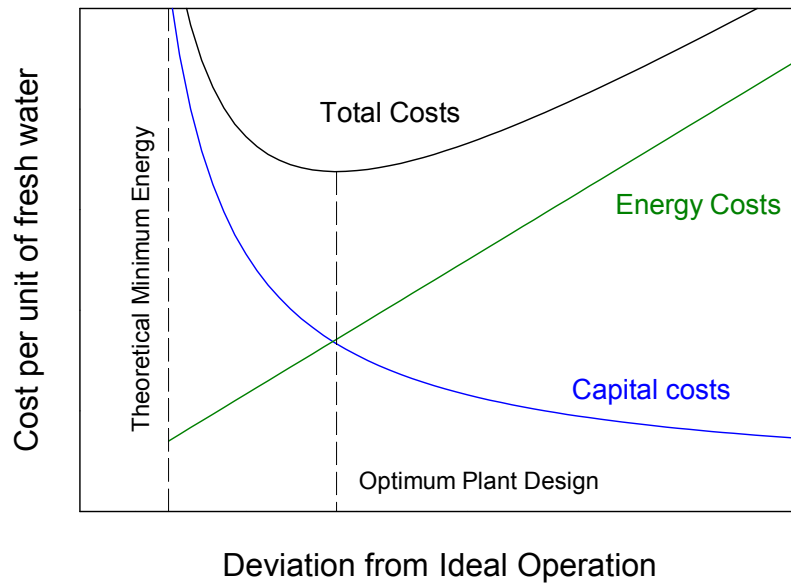

Figure 4. The trade-off between capital costs and energy consumption for practical desalination systems. Adapted from [23] and [25].

Recovery rates are an important design consideration for many reasons in addition to the impact on the energy required for the separation itself. As the recovery rate increases, the potential for scale formation (see below) also increases. This, and the increasing energy

requirements, tend to drive designs towards low recoveries. There are, however, a number of other considerations that drive the design towards maximizing recoveries. First, depending on the plant location, significant energy may be spent transporting the feed to the plant. Then, all of the feed stream, including the fraction that will ultimately be rejected must be pretreated. Therefore it makes economic sense to recover as much water as possible from the feed to minimize transport and pretreatment costs. In addition, energy losses and inefficiencies in the desalination process tend to increase with increasing water rejection. For example, heat is often rejected from a system with the concentrated brine, and energy is lost when concentrated RO brines are depressurized. Another important factor is that significant costs (energy or otherwise) are usually associated with the disposal of the concentrated brine. A good design achieves a balance between all of these factors.

Scaling, i.e. the precipitation on working surfaces of salts due to the concentration process, is always an important design consideration for desalination plants. Fouling of heat or mass transfer surfaces can greatly reduce the capacity and efficiency of a process. Typically, calcium salts, and in particular CaSO_4 and CaCO_3 , are major (but not the only) concerns. In developing a design it is important to understand the chemistry of the specific water that will be treated. There are a number of strategies for preventing scale formation including limiting the operating temperature (calcium salts tend to have retrograde solubility), limiting the water recovery to prevent saturation, chemical pretreatment (e.g. the addition of acids or polyphosphates) to alter the solubility or onset of precipitation of scale formers, and lime or lime-soda softening to remove potential scale formers. In addition, many systems are designed to limit the occurrence or impact of scale and to allow easy maintenance. For example, seed crystals may be added to nucleate the precipitation of scale in the liquid phase or in a specially designed contact bed rather than on critical heat transfer surfaces.

A final criteria important to the design of a desalination system is the quality of the final product water. For example, water that will be used in a semiconductor fab must be virtually contaminant free, while the safe limit for the salinity of drinking water is usually about 1000 ppm (the voluntary EPA standard is 500 ppm [26]). Most crops require water with a salinity of less than 2000 ppm [24]. Distillation processes typically produce water of a higher quality than membrane processes. Chemical processes, e.g. ion exchange, are typically employed to achieve extremely high levels of purity. When considering the quality of water derived from a desalination process, it is important to consider the fact that it may be blended with water from other sources. Depending on the quality of the other sources, this may have the effect of relaxing the specifications for the water produced by the desalination process.

Three Basic Approaches to Desalination

There are three basic approaches to separating water from salt. The first approach is to use thermal means to effect a phase change of the water (to vapor or solid), physically separate the new phase from the remaining salt solution, and then recover the thermal energy for reuse as the separated water reverts to liquid form. Distillation processes were the first desalination processes to be conducted on a large commercial scale and account

for a large portion of the world's desalination capacity. In addition to the thermal component, distillation processes often include vacuum components to increase evaporation at lower temperatures. Although effective, freezing processes have failed to find a significant market.

The second approach to desalination is to physically separate the components, generally with a membrane, as they move in response to an externally applied gradient. The two major processes of this type are reverse osmosis (RO), and electrodialysis (ED). In RO, water passes through a membrane that is impermeable to the solute in response to a chemical potential gradient achieved through pressurization. In ED, ions in solution migrate through anion and cation selective membranes in response to an electric field. Both of these processes have been commercialized on a large scale. The flow through capacitor also uses an electric field to collect and separate dissolved ions from water.

Finally, there are chemical approaches to desalination. This category is more varied than the other two and includes processes such as ion exchange, liquid-liquid extraction, and gas hydrate or other precipitation schemes. Given the maturity of the distillation and membrane processes, novel approaches to desalination are almost by definition chemical processes or a hybrid combination of chemical and other processes. Generally, it is found that chemical approaches are too expensive to apply to the production of fresh water. Ion exchange is an exception in that it is used to soften water, and to manufacture high purity de-ionized water for specialty applications. However, even ion exchange is impractical for treating water with higher levels of dissolved solids.

Major Commercial Processes

Distillation Processes

Multi-stage Flash

Multi-stage flash (MSF) units are widely used in the Middle East (particularly in Saudi Arabia, the United Arab Emirates, and Kuwait) and they account for over 40% of the world's desalination capacity [27]. MSF is a distillation (thermal) process that involves evaporation and condensation of water. The evaporation and condensation steps are coupled in MSF so that the latent heat of evaporation is recovered for reuse by preheating the incoming water (Figure 5). To maximize water recovery, each stage of an MSF unit operates at a successively lower pressure. A key design feature of MSF systems is bulk liquid boiling. This alleviates problems with scale formation on heat transfer tubes. In the Persian Gulf region, large MSF units are often coupled with steam or gas turbine power plants for better utilization of the fuel energy. Steam produced at high temperature and pressure by the fuel is expanded through the turbine to produce electricity. The low to moderate temperature and pressure steam exiting the turbine is used to drive the desalination process [24,28,29]. A performance ratio often applied to thermal desalination processes is the gained output ratio, defined as the mass of water product per mass of heating steam. A typical gained output ratio for MSF units is 8 [24,30,35]. A 20 stage plant has a typical heat requirement of 290 kJ/kg product [24].

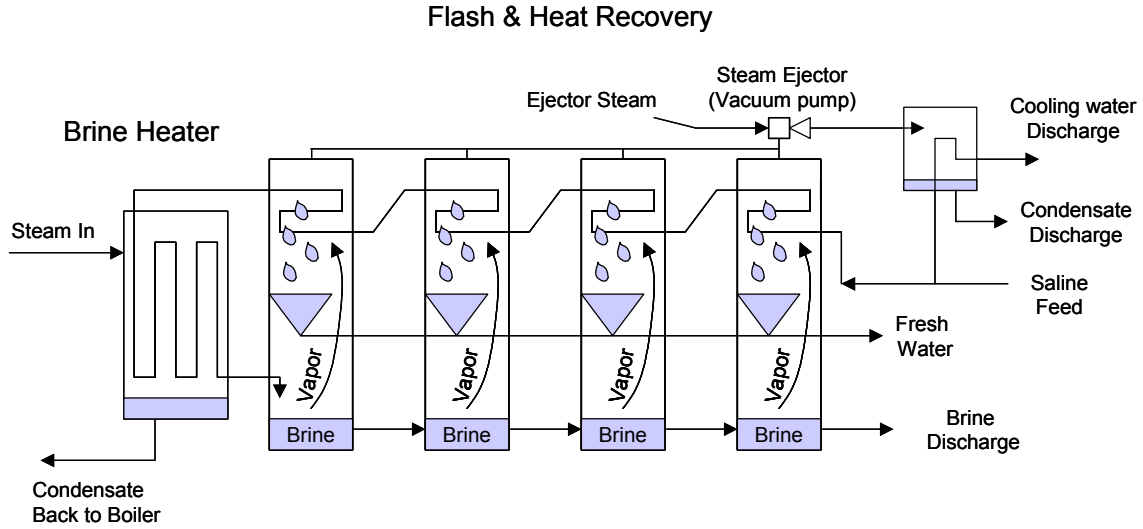

Figure 5. Schematic of multi-stage flash desalination process.

Multi-effect Evaporation

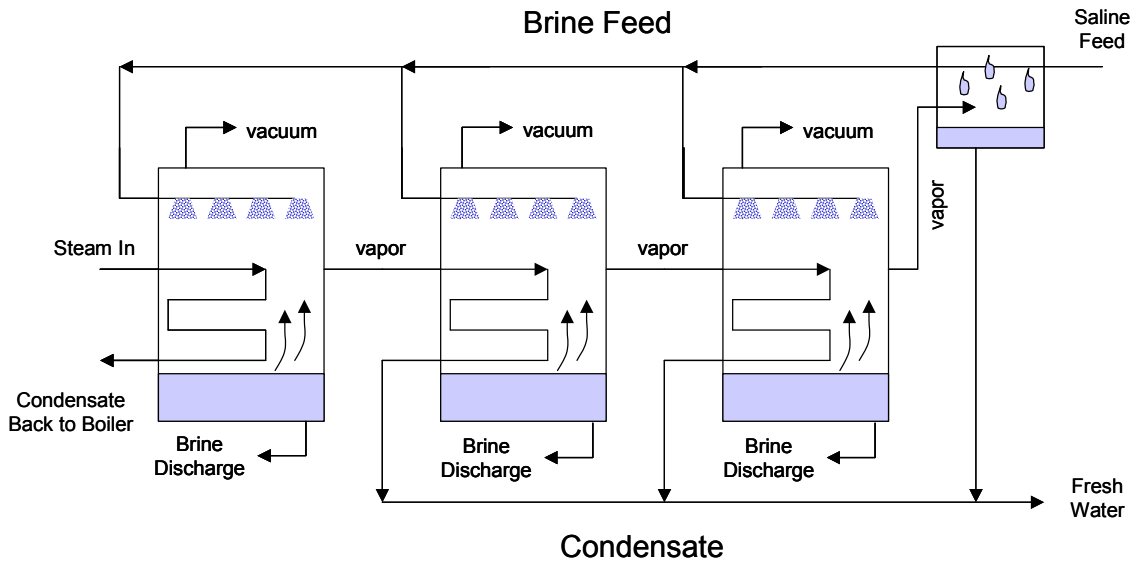

Figure 6. Schematic of multi-effect evaporator desalination process (horizontal tube – parallel feed configuration).

Multi-effect evaporation (MEE) is distillation process related to MSF (Figure 6). MEE was developed early on and plants were installed in the 1950s. However, due to problems with scaling on the heat transfer tubes, it lost favor and was replaced with MSF [31]. MEE is still not widely used, but it has gained attention due to the better thermal performance compared to MSF. Newer plants are designed to limit problems with scaling. In MEE, vapor from each stage is condensed in the next successive stage thereby giving up its heat to drive more evaporation. To increase the performance, each stage is run at a successively lower pressure. This allows the plant to be configured for a

high temperature ($> 90\text{ }^{\circ}\text{C}$) or low temperature ($< 90\text{ }^{\circ}\text{C}$) operation. The top boiling temperature in low temperature plant can be as low as $55\text{ }^{\circ}\text{C}$ which helps reduce corrosion and scaling, and allows the use of low-grade waste heat. The MEE process can have several different configurations according to the type of heat transfer surface (vertical climbing film tube, rising film vertical tube, or horizontal tube falling film) and the direction of the brine flow relative to the vapor flow (forward, backward, or parallel feed) [31]. MEE systems can be combined with heat input between stages from a variety of sources, e.g. by mechanical (MVC, Figure 7) or thermal vapor compression (TVC) [32-34]. Hybrid MEE-TVC systems may have thermal performance ratios (similar to the gain ratio, energy used to evaporate water in all the stages/ first stage energy input) approaching 17 [35], while the combination of MEE with a lithium bromide/water absorption heat pump yielded a thermal performance ratio of 21 [36].

Vapor Compression (Thermal and Mechanical)

Vapor compression processes rely on reduced pressure operation to drive evaporation. The heat for the evaporation is supplied by the compression of the vapor, either with a mechanical compressor (mechanical vapor compression, MVC, Figure 7), or a steam ejector (thermal vapor compression, TVC). Vapor compression processes are particularly useful for small to medium installations [37]. MVC units typically range in size up to about $3,000\text{ m}^3/\text{day}$ while TVC units may range in size to $20,000\text{ m}^3/\text{day}$. MVC systems generally have only a single stage, while TVC systems have several stages. This difference arises from the fact that MVC systems have the same specific power consumption (power/unit water produced) regardless of the number of stages, while the thermal efficiency of TVC systems is increased by adding additional stages [38]. Thus the main advantage of adding effects to an MVC system is simply increased capacity.

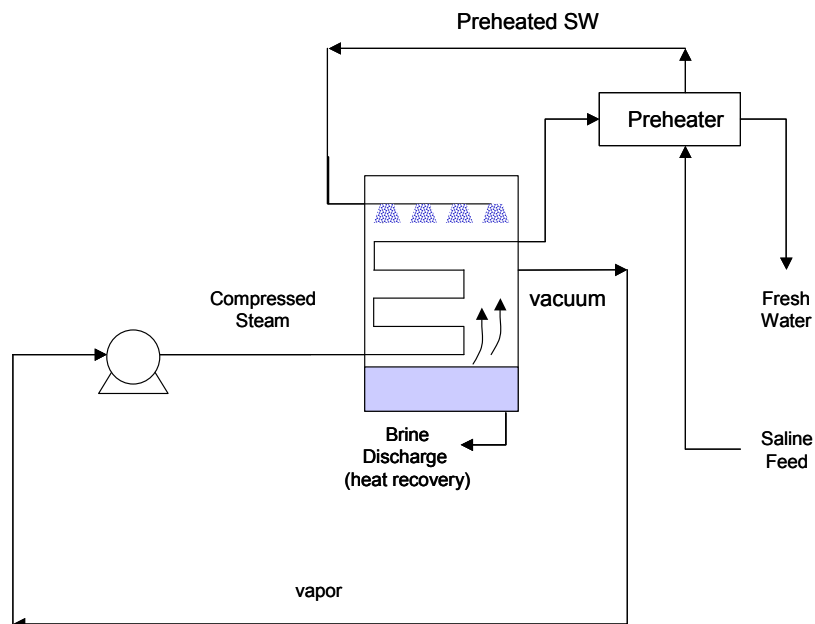

Figure 7. Schematic of single stage mechanical vapor compression desalination process.

Membrane Processes

Reverse Osmosis

Reverse osmosis (RO) is a membrane separation process that recovers water from a saline solution pressurized to a point greater than the osmotic pressure of the solution (Figure 8). The United States ranks second worldwide in desalination capacity, primarily relying on RO to treat brackish and surface water [29]. In essence, the membrane filters out the salt ions from the pressurized solution, allowing only the water to pass. RO post-treatment includes removing dissolved gasses (CO_2), and stabilizing the pH via the addition of Ca or Na salts.

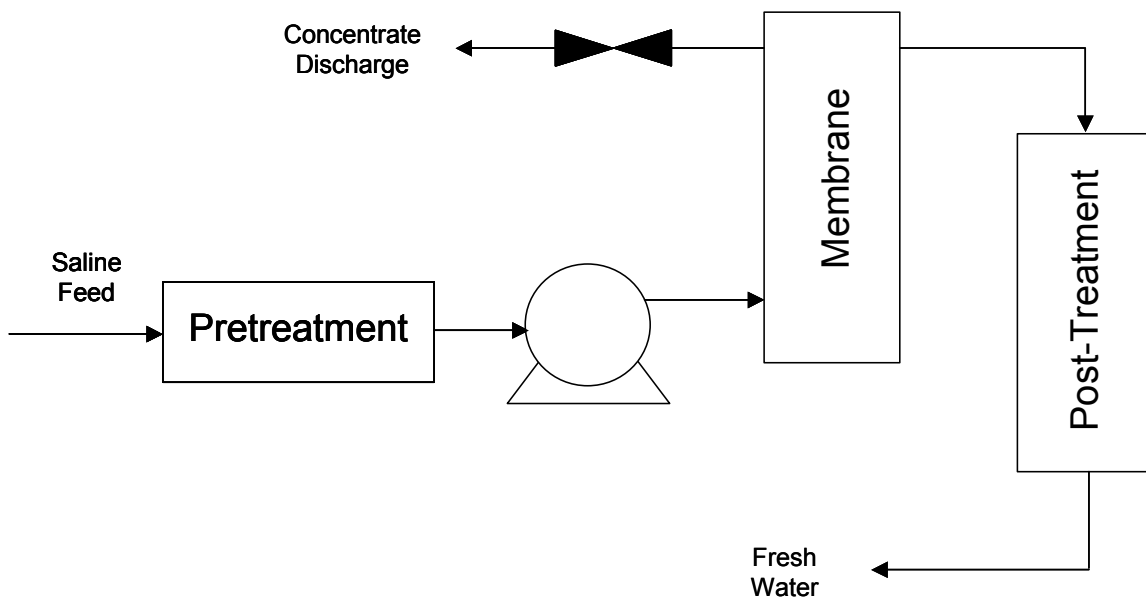

Figure 8. Block diagram of reverse osmosis operations – optional pressure recovery devices not depicted.

Pressurizing the saline water accounts for most of the energy consumed by RO. Since the osmotic pressure, and hence the pressure required to perform the separation is directly related to the salt concentration, RO is often the method of choice for brackish water, where only low to intermediate pressures are required. The operating pressure for brackish water systems ranges from 15 – 25 bar and for seawater systems from 54 to 80 bar (the osmotic pressure of seawater is about 25 bar) [37]. Since the pressure required to recover additional water increases as the brine stream is concentrated, the water recovery rate of RO systems tends to be low. A typical recovery value for a seawater RO system is only 40% [24].

Since most of energy losses for RO result from releasing the pressure of the concentrated brine, large scale RO systems are now equipped with devices to recover the mechanical compression energy from the discharged concentrated brine stream with claimed efficiencies of up to 95% [39]. In these plants, the energy required for seawater desalination has now been reported to be as low as 9 kJ/kg product [40]. This low value

however is more typical of a system treating brackish water. RO membranes are sensitive to pH, oxidizers, a wide range of organics, algae, bacteria and of course particulates and other foulants [29]. Therefore, pretreatment of the feed water is an important consideration and can have a significant impact on the cost of RO [30], especially since all the feed water, even the 60% that will eventually be discharged, must be pretreated before being passed to the membrane.

Electrodialysis

Electrodialysis (ED) utilizes a direct current source and a number of flow channels separated by alternating anion and cation selective membranes to achieve the separation of water and dissolved salts (Figure 9) [37]. Since the driving force for the separation is an electric field, ED is only capable of removing ionic components from solution, unlike RO or distillation.

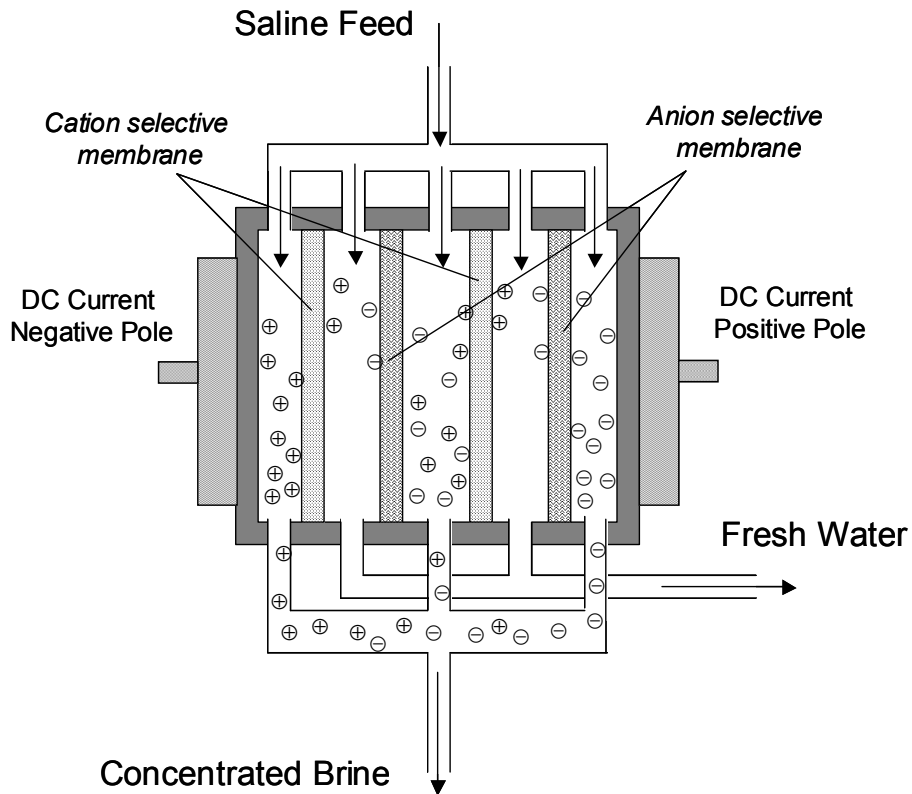

Figure 9. Schematic diagram of electrodesalination process.

In the ED process, saline water is fed in parallel to each of the separate channels. Cations and anions then migrate in opposite directions in response to the applied voltage. Due to the charge selectivity of the membranes, the ion concentration increases and decreases in alternating channels of the apparatus. A single membrane stack may consist of hundreds of these alternating channels. Since the resistance in the stack changes from top to bottom, the separation is typically carried out in a series of small steps. This makes the process more economical and easier to control [24]. Like RO, the energy required to

separate the ions from solution increases with concentration, thus ED is generally limited to brackish waters containing only a few thousand ppm of dissolved solids [24].

The membrane of ED units are subject to fouling, and thus some pretreatment of the feed water is usually necessary. Precipitation of scale can be facilitated in the ED process by changes on pH that occur near the membranes as a result of the transport of H⁺ and OH⁻ ions [24]. However, since there is not a flux of water through the membranes, ED can treat water with a higher level of suspended solids than RO. Also, since nonionic solids, e.g. silica, are not concentrated by the process, these components are of less concern [37]. The electrodialysis reversal (EDR) process was developed to help eliminate membrane fouling. In the EDR process, the membrane polarity is reversed several times an hour. This has the effect of switching the brine channels to freshwater channels, and the freshwater channels to brine channels, and breaks up and flushes out deposits [24,37].

Putting Things in Perspective - Energy Requirements

Energy consumption data for the major desalination processes has been compiled from a number of sources and is presented in Table 3. Although the most efficient process is not always the most cost effective design (Figure 4), this data allows the energy efficiency of different approaches to be compared. As a benchmark, recall that the theoretical minimum energy required to desalt seawater ranges from about 3-7 kJ/kg over the range of practical recoveries (Figure 3). Note that in Table 3, the energy requirements for the thermal processes (MSF, MEE, and VC) are virtually independent of salt concentration, while the energy requirements for the membrane processes are highly dependent on concentration. For this reason, separate data are provided for RO treatment of seawater and brackish water. ED can only be economically applied to brackish water and Table 3 reflects this fact.

Table 3. Energy Use for Desalination (kJ/kg fresh water – divide by 3.6 for kWh/m³)

Reference	MSF	MEE	VC	Seawater RO	Brackish RO	Brackish ED
A	299			61		
B	95			15-28		
C	230			27		
D	290		100-120*	23-30		4
E	216-288			18-22	11	
F			25-43	11		
G			29-39	15-28		
H	95-252*	107-132 [†]	22-29			
I			14-29			
J			22-58			
K			26			
L			37-40			
M		95-275*				
N		152				
O						0.4-1.8

P				8.6		
Q				14-20		
R				14	7.2	
S				18-24		

- A. R.V. Wahlgren, *Wat. Res.* 35 (2001) 1.
 B. L. Awerbuch, Proc. IDA World Congress on Desalination and Water Reuse, Madrid, 4 (1997)181.
 C. M.A. Darwish; N.M. Al-Najem, *Applied Thermal Engineering* 20 (2000) 399.
 D. K.S. Spiegler and Y.M. El-Sayed, *A Desalination Primer*, Balaban Desalination Publications, Santa Maria Imbaro, Italy (1994). * Energy for small portable systems.
 E. K.E. Thomas, NREL report TP-440-22083 (1997).
 F. O.K. Buros, "The ABCs of Desalting, Second ed." International Desalination Association, Topsfield, Mass, 2000.
 G. L. Awerbuch, Proc. Intl. Symposium on Desalination of Seawater with Nuclear Energy, IAEA (1997) 413.
 H. H.M. Ettouney, H.T. El-Dessouky, I. Alatiqi, *Chemical Engineering Progress*, September 1999, 43. * 95 seems questionably low since the gained output ratio was stated to be 8. † calculated using thermal gain ratios of 17 and 21 quoted in text.
 I. F. Mandani, H. Ettouney, H. El-Dessouky, *Desalination* 128 (2000) 161.
 J. F. Al-Juwayhel, H. El-Dessouky, H. Ettouney, *Desalination* (1997) 253.
 K. S.E. Aly, *Energy Conversion and Management* 40 (1999) 729.
 L. J.M. Veza, *Desalination* 101 (1995) 1.
 M. M. Al-Shammiri, M. Safar, *Desalination* 126 (1999) 45. * Based on gain ratios of 8-24.
 N. V. Dvornikov, *Desalination* 127 (2000) 261 – base case from Table 3.
 O. M. Memicioglu, N. Kabay, E. Ersoz, I. Kurucaovali, C. Safak, N. Gizli, *Desalination* 136 (2001) 317.
 P. G.G. Pique, *Water Conditioning and Purification*, July 2000.
 Q. M. Wilf, K. Klinko, *Desalination* 138 (2001) 299.
 R. P. Glueckstern, A. Thoma, M. Priel, *Desalination* 139 (2001) 217.
 S. R. Rautenbach, K. Vosenkaul, *Separation and Purification Technology* 22 (2001) 193.

The values for any given process in Table 3, show a fairly wide variation. This variation results from a number of factors including differences in the size and configuration of the units, technological advances, and the quality of the feed stream being treated. There are also variations in what is included in the energy calculation. In some cases, authors have declined to include thermal energy obtained from waste heat sources as part of the calculation, and instead only account for energy that is used in addition to this heat or that is diverted from the main process (usually electric power generation) as it is typically run. Using this type of accounting, MEE processes have reported to consume as little 20 kJ/kg [41]. These calculations are instructive from a economic standpoint, and illustrate the advantages of integrating desalination with other processes. However, they are not helpful in comparing stand-alone desalination processes. Therefore, we have tried to avoid including these types of figures in the table.

Despite the variations, it is fair to say that Table 3 reveals that of the thermal processes, MSF consumes the most energy, despite its relative maturity (at least 50 years). MSF is followed by MEE (or hybrid MEE) systems and then vapor compression systems. None of the processes performs particularly well when compared to the theoretical minimum values. The energy consumption of MSF, by far the most widely used thermal process (see below), is still at least 30 times the theoretical minimum. RO is a newer technology (30 years) that with recent improvements in energy recovery is remarkably efficient, consuming only 3 to 10 times the theoretical minimum (using the conservative 3 kJ/kg number). This of course is an indication that RO is closer to being a thermodynamically reversible process than the distillation methods. It is important to consider however that RO consumes energy in the form of electricity. On the other hand, MSF uses heat (or fuel) more directly. The conversion of thermal energy to electrical energy is only about

35% efficient. Therefore, on a fuel basis, RO consumes 9-30 times the theoretical energy requirement.

Putting Things in Perspective - Desalination Costs

Reported Costs for Desalination

Table 4 presents the costs compiled from the literature for water produced by each of the major desalination methods. Cost figures are inherently more variable and uncertain than energy consumption figures. A primary reason for this is that many costs, energy costs in particular, greatly vary over time, geography, and, for RO and ED, concentration. In addition, factors such as feed water quality determine the degree of pretreatment necessary, and thus the pretreatment costs. Also, the costs of transporting the water to the treatment or distribution site (e.g. from the ocean inland) will vary by location, as will the cost of disposing of the concentrated brine solution. Furthermore, factors such as low interest government financing or subsidies can significantly influence capital and other costs. The size of the plant is also a critical factor.

To further complicate matters, it has been pointed out that there is no agreed on standard for computing and reporting water costs [42]. Some authors have chosen to neglect capital costs, some have chosen to report all costs including delivery costs, and some report design costs that do not ultimately reflect actual operating expenses. These and other factors lead us to caution that the numbers in Table 4 should be used as rough guides in aggregate, or understood in their specific context. For the most part, these costs should be understood to be most applicable to reasonably populated and industrialized regions. Costs in less developed parts of the world will be greater.

Due to geographical variation, government influence and social policies, water quality, custom, and other factors, the price consumers pay for water varies according to location, application, and quantity. Also, one should note that in many cases, the price consumers pay does not accurately reflect the actual cost of producing or delivering the water, and almost never reflects “opportunity costs”. Therefore, it is difficult to provide a single meaningful benchmark for the current cost (or even the price) of freshwater provided from traditional sources. However, we note that in 1994, the price of water for domestic residential consumption averaged about \$0.53/m³ (\$2.00/1000 gal) with a high of about \$1.70/m³ and a low of less than \$0.20/m³ [20]. Despite the fact that Albuquerque consumes water from an aquifer at an unsustainable rate, the price of water for an average user in Albuquerque is only \$22.64/9000 gallons or about \$0.66/m³ [43] or about \$0.29/m³ for all users [44].

The prices (and sometimes costs) for agricultural water are far more difficult to pinpoint, but in general are significantly lower than prices for residential and other types of commercial activity. However, the comparisons are often misleading because government financed water projects and policies favoring agriculture have significantly altered pricing structures in many regions [21]. A few reports out of California illustrate this point. It has been reported that, on average, farmers in California pay about \$70/acre-foot (less than \$0.06/m³) for irrigation water [45]. It is also reported that many

farmers pay between \$2 and \$20/acre-foot which can be as little as 10% of the water's actual cost [46]. Most of California's allotment from the Colorado River goes to the Imperial Irrigation District (2.8 million acre-feet), and the Metropolitan Water District (500,000 acre-feet), a water wholesaler for Southern California. The MWD sells water for \$431/acre-foot (\$0.35/m³), while the IID sells irrigation water for \$14/acre-foot (\$0.011/m³) [47].

Table 4. Desalination Costs (\$/m³ fresh water – multiply by 3.8 for \$/1000 gal)

Reference	MSF	MEE	VC	Seawater RO	Brackish RO	Brackish ED
A	1.10-1.50	0.46-85	0.87-0.92	0.45-0.92	0.20-0.35	
B	0.80	0.45		0.72-0.93		
C	0.89	0.27-0.56		0.68		
D	0.70-0.75			0.45-0.85	0.25-0.60	
E				1.54	0.35	
F				1.50	0.37-0.70	0.58
G	1.31-5.36			1.54-6.56		
H	1.86	1.49				
I		1.35		1.06		
J				1.25		
K	1.22					
L					0.18-0.56	
M			0.46			
N				1.18		
O		1.17				
P			0.99-1.21			
Q				0.55-0.80	0.25-0.28	
R				0.59-1.62		
S				1.38-1.51		
T				0.55-0.63		
U				0.70-0.80		
V					0.27*	
W				0.52		

A. R. Semiat, *Water International* 25 (2000) 54.

B. J. Bednarski, M. Minamide, O.J. Morin, Proc., IDA World Congress on Desalination and Water Science, Madrid, 1 (1997) 227.

C. G. Kronenberg, Proc., IDA World Congress on Desalination and Water Science, Abu Dhabi, 3 (1995) 459.

D. O.K. Buros, "The ABCs of Desalting, Second ed." International Desalination Association, Topsfield, Mass, 2000.

E. F.I.A. Cortes and A.M. Dominguez, *Ingenieria Hidraulica En Mexico* 15 (2000) 27.

F. K.S. Spiegler and Y.M. El-Sayed, *A Desalination Primer*, Balaban Desalination Publications, Santa Maria Imbaro, Italy (1994).

G. R.V. Wahlgren, *Wat. Res.* 35 (2001) 1.

H. O.J. Morin, *Desalination* 93 (1993) 343.

I. G. Hess and O.J. Morin, *Desalination* 87 (1992) 55 – updated to 1997 \$ in Al-Juwayhel, H. El-Dessouky, H. Ettouney, *Desalination* (1997) 253.

J. E. Drioli, F. Lagana, A. Criscuoli, G. Barbieri, *Desalination* 122 (1999) 141.

K. T.M. Leahy, *Int. Desalination and Water Reuse* 7 (1998) 2832.

L. J.S. Taylor and E.P. Jacobs in *Water Treatment Membrane Processes*, Mallevalle, Odendaal, Wiesner, eds. McGraw-Hill, New York (1996).

M. Z. Zimmerman, *Desalination* 96 (1994) 51.

N. "Survey of U.S. Costs and Water Rates for Desalination and Membrane Softening Units" U.S. Bureau of Reclamation Desalination and Water Purification Research and Development Program Report No. 24, July, 1997.

O. V. Dvornikov, *Desalination* 127 (2000) 261.
P. Y.M. El-Sayed, *Desalination* 125 (1999) 251.
Q. J.A. Redondo, *Desalination* 138 (2001) 29.
R. G. F. Leitner, *Desalination* 81 (1991) 39.
S. A. Malek, M.N.A. Hawlader, J.C. Ho, *Desalination* 105 (1996) 245.
T. P. Glueckstern, M. Priel, *Desalination* 119 (1998) 33.
U. M. Wilf, K. Klinko, *Desalination* 138 (2001) 299.
V. D.L. Brown, *Desalination and Water Reuse Quarterly* 6 (1996) 20. * Capital costs not included.
W. G. Leitner, *Desalination* 102 (1995) 199.

Table 4 clearly illustrates that RO has a significant economic advantage for treating brackish waters. Price quotes for ED are not readily available, an indication of small market share relative to RO. For desalination of seawater, RO clearly has an economic advantage over MSF. The situation is not as clear cut for RO and MEE. The widespread acceptance and application of RO (see below) lends greater credibility to cost estimates for this process, and it appears to be generally accepted that seawater RO can be carried out in the U.S. for somewhere in the range of \$0.50/m³. In contrast, although gaining new acceptance, MEE plants are uncommon, show great variation in design, and are relatively unproven on large scales. Thus, claims that MEE is cost competitive with RO are viewed by some with skepticism [21]. Recent improvements in energy recovery for RO are likely to further fuel this skepticism. Yet, the economics of low temperature MEE systems that are integrated with other processes to utilize waste heat are probably favorable [41].

As a final note to this section, water produced by desalination is often blended with water from other freshwater sources before distribution. This seems to be particularly true in the United States. This has two notable impacts. First, the specifications for the desalination process may be relaxed. That is, product water from the desalination process will be diluted with water from other sources and therefore a less perfect separation may be acceptable. This of course is mainly a factor for the membrane processes. The second impact is on the overall cost of water delivered to the consumer. While the cost of water produced by desalination may be higher than the cost of more traditional sources, the price the consumer must pay is only increased incrementally in proportion to the contribution of desalinated water to the overall supply. Hence, the overall price the consumer must pay is impacted in a lesser way [20].

Major Cost Components of Desalination

In order to understand how to lower the cost of desalination, one must first understand what factors contribute to the cost. From the discussions above, it is clear that RO and MEE currently have the most favorable economics and lowest energy consumption. Therefore, we will focus the discussion on these technologies.

Figure 10 quantifies the contribution of various factors to the overall cost of desalting brackish water. Over one half of the cost is directly tied to the capital investment required to build the plant. The remaining portion is split among various operating costs. As indicated above, the energy consumption of a brackish water RO plant is very low, and this is reflected in the fact that only 11% of the total cost can be traced to energy usage. The consumables category (10% overall) includes various chemicals that are used to pre- and post-treat the water. Maintaining the plant, including replacing the

membranes approximately every three years, adds about 16% to the water cost. Labor accounts for the final 9%. One conclusion that can be drawn from this analysis is that, apart from fixed costs, improvements in any one aspect of plant operation will only result in incremental improvement (less than 10%) in the overall cost of brackish water RO.

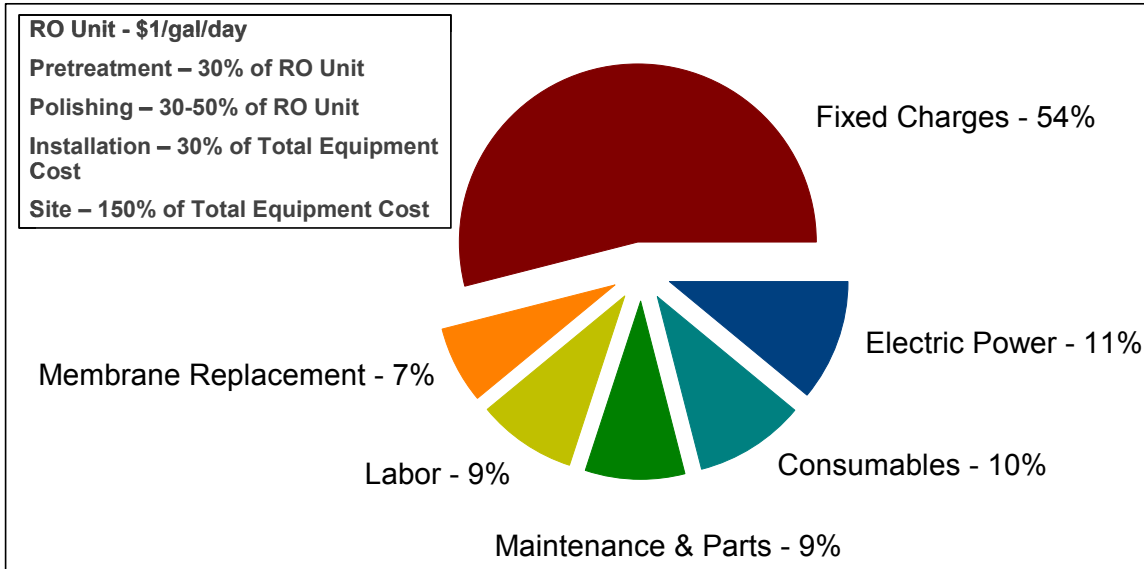

Figure 10. Cost breakdown for RO desalination of brackish water. Adapted from [48].

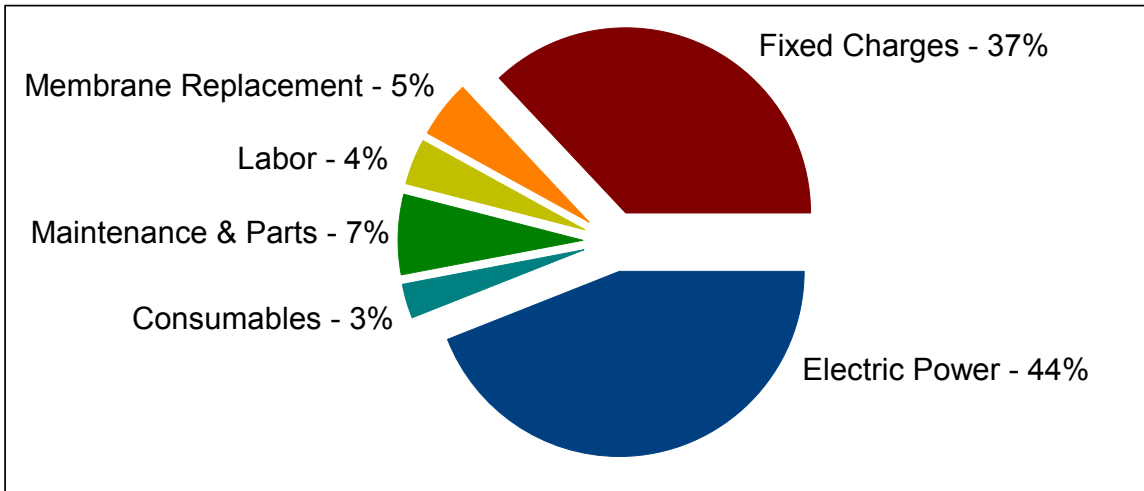

Figure 11. Cost breakdown for RO desalination of seawater. Adapted from [49].

The inset in Figure 10 shows an approximate breakdown of the fixed costs for an RO plant as outlined by Pittner [48]. The membrane contactor and associated components can be purchased for about \$1 per gallon/day capacity. The other process units sum to about \$0.60 - \$0.80 per gallon/day capacity. Purchasing the site and installing the equipment adds about another \$3 per gallon/day for a total of about \$4.50 - \$5.00 per gallon/day (\$1188 - \$1320 per m³/day) of capacity. These rough numbers from 1993 are slightly higher than the \$2.88 - \$3.95 range cited in 1998 [50] for 24 million gallon/day plants (RO, MSF, MVC, or MEE), but within the range of \$3.65 - \$8.50 reported for three select seawater RO plants in 1991 [51]. Other than purchasing the site, the largest

contributor to the capital cost is the membrane unit, which accounts for about 20% of the capital or less than 11% of the overall cost. Thus, this analysis also indicates that within the capital costs, there is no one factor that can be addressed to impact the overall cost in more than an incremental factor. Nonetheless, improvements are continually being made, and have contributed to improved economics. For example, for many years improvements in membrane technology allowed the cost of the membrane unit to remain fixed at about \$1.00 per gallon/day despite inflation [48].

Figure 11 illustrates the cost breakdown for RO desalination of seawater. The categories are the same as those used in Figure 10, and a comparison shows that the major difference is the increased energy consumption (from 11% to 44%) for treating seawater. The remaining factors are the same, but have been decreased proportionally. Thus, energy recovery schemes are important to seawater RO, since reducing the energy consumption can have a major impact on the overall water cost.

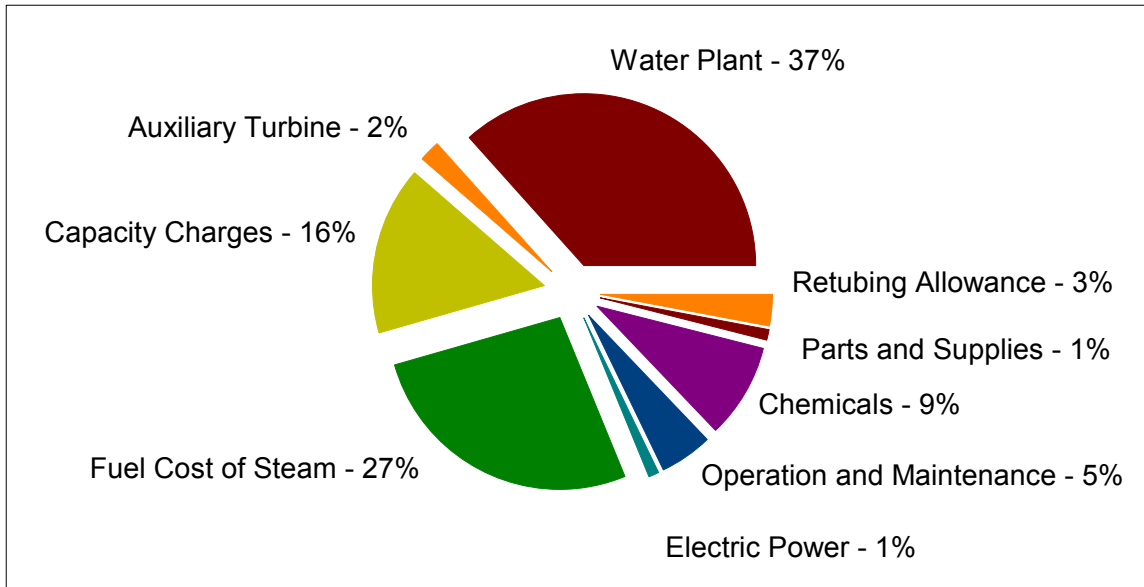

Figure 12. Cost breakdown (design costs) for MEE desalination of seawater. Adapted from [52] and [53].

The factors contributing to the cost of desalinating seawater via MEE are shown in Figure 12. The numbers were taken from a new state-of-the-art design for a 75 million gallon/day plant coupled to a combined cycle steam turbine power generating plant for the Metropolitan Water District of Southern California, rather than actual operating experience [53]. Although there are a few new categories, the overall picture is somewhat similar to the case for seawater RO. The two biggest factors in the total cost are capital investment (39% for the water plant and auxiliary turbine), and energy expenditures (28% for steam and electric power). Capacity charges are the only other expenditure accounting for more than 10% of the total. Similar to RO the remaining charges are for chemicals and for operation and maintenance and associated supplies and sum to less than 20% of the total.

Other Cost Considerations

There are a number of additional factors, generally site specific concerns, that can contribute to the costs and influence the feasibility of a desalination process. One major factor that is not addressed thoroughly above is pretreatment. In short, the degree to which the feed stream contains potential foulants such as scale formers, particulates, and biological components may have a major impact on the overall costs. In extreme cases with very poor quality feeds, pretreatment can account for up to 30% of the total operating costs of RO systems [24]. Therefore, improvements in the pretreatment may also have a significant impact on overall water cost.

A second major consideration is the cost and impact of concentrated brine disposal [54]. In fact, brine disposal is often cited as one of the major problems of desalination [55], and is probably a factor limiting the growth of the industry [21]. Brine disposal is particularly a problem for inland desalination. The potential for large volumes of concentrated brines or of solid, but soluble salts, to damage the environment must be taken into account. The options for brine disposal range from returning flow to the intake or another tributary, to deep well injection, or evaporation and landfill via ponds or spray drying. For coastal desalination, return flow to the ocean is possible, but again environmental concerns regarding estuaries may prevent permitting or require outflow far from shore. In response to these concerns several authors have suggested potential beneficial uses for concentrated brines, for example recovery of mineral commodities [56], or wetland habitat development [57], that could help offset the costs of brine disposal.

World-wide Desalination Capacity

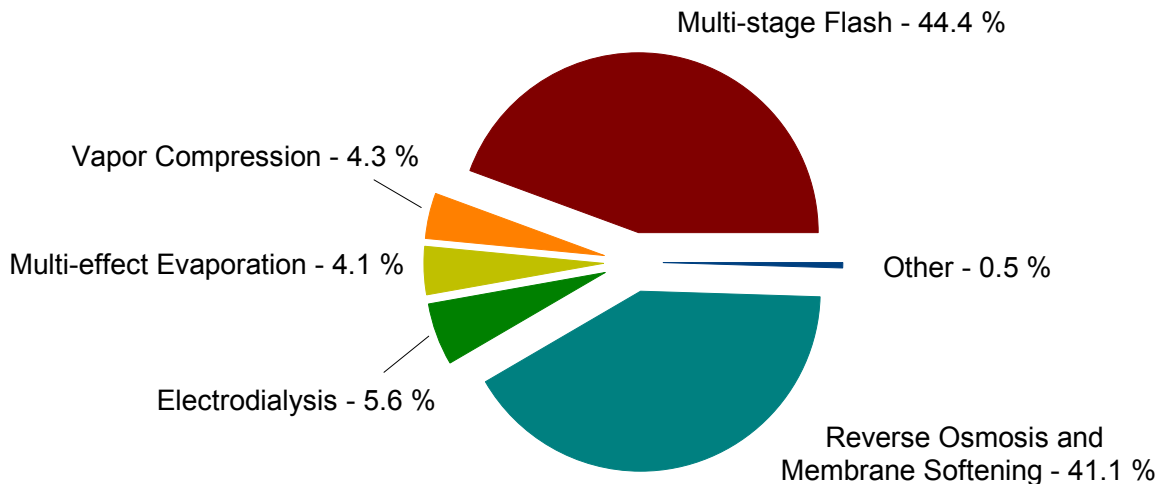

Figure 13. Global distribution of installed desalination capacity by technology. Adapted from [58].

The application of the major technologies to desalination around the world, according to a 1998 survey, is shown in Figure 13. As indicated above, MSF and RO dominate, accounting for more than 85% of the total. Although capacity was about equally divided

between the membrane processes and the thermal processes, current trends suggest that the membrane processes are now preferred and will ultimately dominate the market.

The distribution of desalination capacity by country is given in Table 5. In 1998, the top 11 countries accounted for more than 75% of the global capacity. Not surprisingly, 6 of the top 11 countries are located in the Middle East. Thermal processes are dominant in this region for two reasons: abundant energy resources, and a historical reliance on desalination that predates the advent of modern RO membranes. The United States is second only to Saudi Arabia in desalination capacity. The growth of desalination in the U.S. is closely linked to advances in membrane technology over the past several decades. In particular, the advent of membrane processes has led to the treatment of brackish water sources that could not be economically treated via thermal means.

Table 5. Installed Desalination Capacity by Country (multiply m³/day by 264 for gal/day). Adapted from [58].

Country	Total Capacity (m ³ /day)	% of Global Production	MSF	MEE	MVC	RO	ED
Saudi Arabia	5,253,200	25.9	65.7	0.3	1.2	31	1.9
United States	3,092,500	15.2	1.7	1.8	4.5	78	11.4
United Arab Emirates	2,164,500	10.7	89.8	0.4	3.0	6.5	0.2
Kuwait	1,538,400	7.6	95.5	0.7	0.0	3.4	0.3
Japan	745,300	3.7	4.7	2.0	0.0	86.4	6.8
Libya	683,300	3.4	67.7	0.9	1.8	19.6	9.8
Qatar	566,900	2.8	94.4	0.6	3.3	0.0	0.0
Spain	529,900	2.6	10.6	0.9	8.7	68.9	10.9
Italy	518,700	2.6	43.2	1.9	15.1	20.4	19.2
Bahrain	309,200	1.5	52.0	0.0	1.5	41.7	4.5
Oman	192,000	0.9	84.1	2.2	0.0	11.7	0.0
Total	15,594,500	76.9					

Major Suppliers of Desalination Equipment and Technology

Leitner and Murney have provided an overview of publicly owned and traded companies that dealing in water treatment and purification throughout the world [59]. A similar listing of companies who have manufactured desalination equipment for installation in the USA has been Leitner and Associates and published by the Bureau of Reclamation [20]. Since the publication of the Leitner article, Suez (a French company) has acquired Degremont and Lyonnaise Des Eaux-Dumez and now operates these businesses under the name Ondeo [60]. Ondeo has also recently acquired US Water which it will merge with United Water Resources, a wholly owned subsidiary operating in North America [61]. Vivendi, also a French company, acquired US Filter. Vivendi has since combined with Seagrams to become Vivendi-Universal, and later spun off water and related businesses as Vivendi Environnement. Table 6 compiles and updates the lists from both sources.

The International Desalination Association also publishes an annual directory of desalination products and services.

Table 6. Major commercial suppliers of water treatment and purification technology. Adapted from [20 and 59].

Company	Headquarters
American Engineering Services	USA
Anglian Water PLC	United Kingdom
Ansaldo SPA	Italy
Aqua Chem, Inc.	USA
Aqua Design (Ionics)	USA
ASI	USA
Cayman Water Company, Ltd.	British West Indies
Culligan Water Technologies, Inc.	USA
Degremont SA (now Suez)	France
Dow Chemical Company (FilmTec)	USA
E.I. Dupont De Nemours and Company	USA
Fluid Systems	USA
Ham RO Systems, Inc.	USA
Hydranautics, Inc.	USA
Hydropure, Inc.	USA
Ionics, Inc.	USA
Israel Desalination Engineers	USA
Lyonnais Des Eaux-Dumez (now Suez)	France
Mechanical Equipment Co.	USA
Memtec America	USA
Osmonics	USA
Polymetrics Seawater Systems	USA
Source, Inc.	USA
Suez (Ondeo)	France
Trisep Corp.	USA
United Water Resources (Suez)	USA (France)
US Filter (now owned by Vivendi)	USA (France)
US Water (Suez)	USA (France)
Vivendi Environnement	France
Water Equipment Technology	USA
The Weir Group PLC	Scotland

Financing Desalination

Large scale desalination projects are extremely expensive and often require a least some degree of public financing. Building a 24 million gal/day plant requires about \$69 to \$95 million [50]. In recent years, however, contractual arrangements between governments and suppliers, in which the parties enter into an agreement to sell/purchase water at some price have become more common. The supplier is then free to build and operate the technology of his or her choice. There are generally two types of arrangements: BOO (build, own, operate) and BOOT or BOT (build, operate, transfer). A recent article reviews these financing structures and compares desalination to other infrastructure projects [62].

Conclusions

Desalination has now been practiced on a large scale for more than 50 years. During this time continual improvements have been made, and the major technologies are now remarkably efficient, reliable, and inexpensive. For many years, thermal technologies were the only viable option, and MSF was established as the baseline technology. MEE is now the state-of-the-art thermal technology. With the growth of membrane science, RO overtook MSF as the leading desalination technology, and should now be considered to be the baseline technology. Since RO is a fairly mature technology, further improvements are likely to be incremental in nature, unless design improvements allow major savings in capital costs. Therefore, the best hope to dramatically decrease desalination costs is to develop “out of the box” technologies. These “out of the box approaches” must offer a significant advantage over RO (or MEE if waste heat is available) if they are to be viable. When making these comparisons, it is crucial that the specifics of the calculation are understood so that the comparison is made on a fair and equivalent basis.

Alternate Processes

We now undertake the task of describing a number of approaches to desalination that have been proposed as alternatives to the major commercial processes. The discussion is not meant to be all-inclusive, but rather to provide a sense of the wide variety of approaches that have been investigated. Despite the large number and seeming diversity of the approaches, they generally can all be classified into one or more of the basic approaches outlined above: thermal, physical, or chemical.

Crystallization Processes

These desalination processes are based on a liquid to solid phase change coupled with a physical process to separate the solids from the remaining liquid phase. The bulk handling of solids is an added complexity that is not required for other processes. The phase change must be selective to either the water or the salt in order for the separation to achieve the desired result. The traditional approach is to accomplish the phase change through thermal means. In freeze desalination refrigeration is provided to freeze and precipitate the water, leaving behind a concentrated brine solution. A non-traditional, non-thermal approach is to use elevated pressures to precipitate the water as gas hydrates or clathrates.

Freeze desalination

The concept of freeze desalination dates to at least the 1950s, and most of the literature on the subject dates back to the 1950s, 60s, and 70s [63-68]. Although the water itself can be used as a refrigerant, most process designs employ a secondary refrigerant. In a direct freezing process, the refrigerant is mixed directly with the brine. In an indirect process, the refrigerant is separated from the brine by a heat transfer surface. A schematic of an indirect process is shown in Figure 14. The process is essentially a conventional compressor driven refrigeration cycle with the evaporator serving as the ice freezer, and

the condenser as the ice melter. The ice, in the form of small crystals, forms a slush with the brine. There are a number of schemes to separate the ice from the brine including centrifugation. One of the practical schemes involves flowing the slush upward in the column. The brine is then drawn off through peripheral discharge screens. A counter current flow of freshwater is fed into the top of the column to wash any remaining brine from the ice. The washing can be accomplished with the loss of only a few percent of the freshwater product. The ice is then fed to the melter where freshwater is recovered. A heat exchanger is used to recover energy from the freshwater and reject brine by precooling the feed [24].

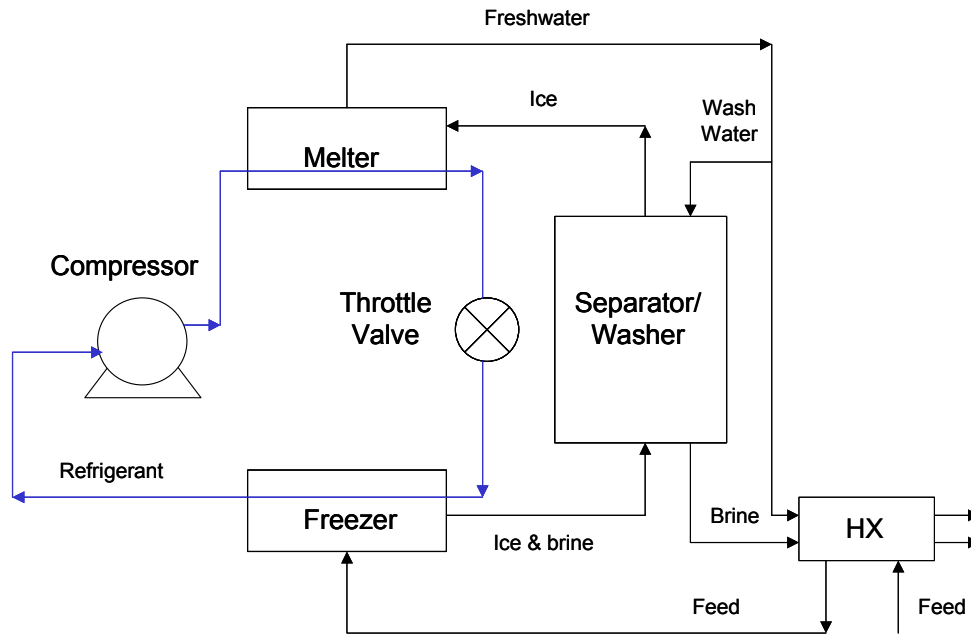

Figure 14. Schematic diagram of an indirect contact freeze desalination process. Adapted from [24].

Direct contact freeze desalination processes may use water itself as a refrigerant, but it must operate under significant vacuum. The Zarchin process, operating at 3-4 Torr, uses this approach. The advantage to this approach is that the compressor operates over a smaller temperature range, and thus requires less work per unit of freshwater product [24]. Butane can also be used as a refrigerant in direct contact processes. The advantage of butane is that the process does not have to be vacuum tight.

Despite the fact that the direct contact processes can be quite efficient, they have never been utilized for desalination on a large scale, due to a number of practical considerations including designing and sizing the components, operating and controlling the solids handling operations, and numerous problems with the compressors. Compressors designed for use with low pressure refrigerants such as butane have generally been unavailable and untested. In addition, the compressor requires lubrication, which can contaminate the water, or become contaminated with water unless demisters and desiccators are added to the plant. One potential solution to this problem is to replace the compressor driven refrigeration cycle with thermally driven adsorption heat pumps,

which may also offer increased efficiency [24]. Another recently proposed solution is the application of a hydraulic refrigerant compressor, which utilizes a flowing liquid stream (e.g. water) and a hydrostatic head to compress the refrigerant [69].

An intriguing variation of freeze desalination is to employ the naturally occurring freeze-thaw cycle of the winter months to desalt water for later application to agriculture, or to augment other water supplies [70-75]. A recent study of applying this approach to saline groundwater (5,000 ppm) in North Dakota concluded that a 1 million gal/day plant could produce water for a cost of \$1.30/1000 gallons (\$0.34/m³) [76], which, if true, makes the process competitive with RO (Table 4).

Gas Hydrate processes

Gas hydrates (or clathrates) are crystalline aggregations of hydrogen bonded water molecules around a central gas molecule. These crystalline compounds generally form under moderately elevated pressures, but are known to have freezing points at least as high as 12 °C. Known clathrate formers include light hydrocarbons (e.g. propane), and chlorofluorocarbon refrigerants (e.g. CHClF₂). The ratio of water to gas molecules ranges from 6-17 for known compounds.

A hydrate freezing process can be envisioned as being very similar to a direct contact freezing process utilizing a secondary refrigerant. In the freezing section, gas and water would be mixed and hydrates would precipitate. The crystals would be physically separated from the remaining brine, washed, and melted. The gas volatilize away from the water and be recovered for reuse. A potential advantage of the process is the fact that it could operate at a higher temperature than a conventional freezing process, potentially decreasing the energy requirements of the plant. However, it would also probably operate at a higher pressure.

In the 1960's the Interior Department's Office of Saline Water sponsored the construction of a number of freeze desalination pilot plants, two of which used clathrate approaches (CCl₂F₂, and butane). Ultimately the plants were unsuccessful because the hydrate crystals were very small or dendritic, and were difficult to separate from the brine [77]. More recently, the Bureau of Reclamation sponsored a preliminary study [78], followed by a pilot test conducted at the Natural Energy Laboratory of Hawaii [79]. The test was somewhat successful, although a wash column was never built and tested as part of the operation. Estimates of water cost arising from the test were \$0.46-0.52/m³ with favorable public financing and \$0.59-0.68/m³ with private financing. Problems with the test including difficulty in separating the crystals and materials compatibility led to a follow-on program which included tasks to determine the filterability of clathrate crystals, the design and operation of a wash column, and surveying alternate higher temperature clathrate formers [80].

Humidification Processes

Humidification processes are based on thermally driven evaporation of water, similar to MSF and MEE. They differ from MSF and MEE in that the evaporating water is not

processed as pure vapor or steam, but rather is used to humidify a process gas stream (typically air). Humidification processes are typically designed operate at low temperatures, allowing them to make use of low grade or waste heat. However, as illustrated in Figure 15, the water content of saturated air at low (near ambient) temperature conditions is very small, thereby requiring large volumes of air to be circulated through the system. Since the saturation humidity roughly doubles for every 10 °C increase in temperature, the volume of air that must be processed and hence the system size and operating costs are strongly dependent on the operating temperature. Several specific approaches to desalination via humidification are outlined below.

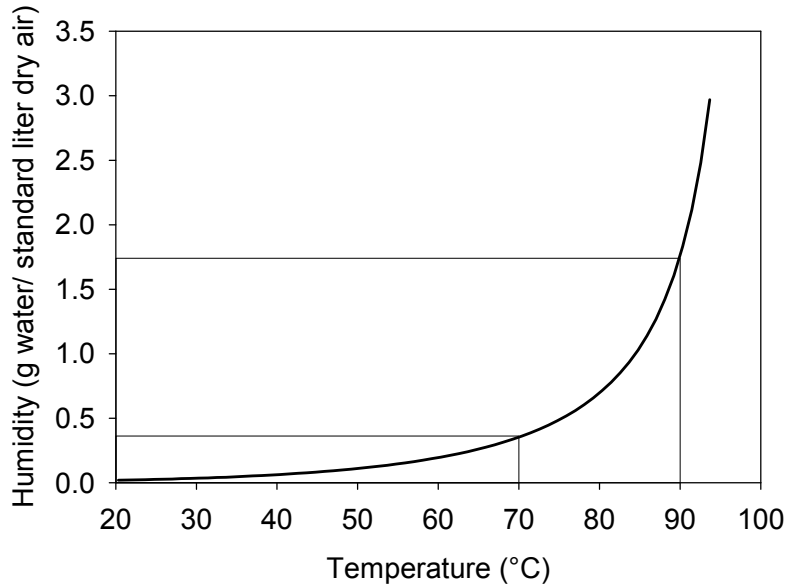

Figure 15. Saturation humidity of air as a function of temperature – adapted from “Perry’s Chemical Engineering Handbook, 6th edition”. The saturation humidity roughly doubles for every 10 °C increase in temperature; Air at 90 °C can hold five times more water than air at 70 °C.

Dewvaporation process

The Dewvaporation process was recently developed at Arizona State University [81-83]. In this process, an upward flowing stream of air is humidified by a falling film of saline water that wets one side of a heat transfer surface. At the top of the tower, the air is heated by an external thermal source (e.g. solar). The heated air is then forced down the opposite side of the tower where it releases heat through the heat transfer surface to the evaporation side, and causing dew formation. This purified water is collected at the bottom of the tower. Economic analysis indicate that a 1000 gal/day unit could be built for as little as \$1,397, and operated with natural gas for \$3.35/day or with waste heat for \$1.52/day [81]. A small unit (20 ft² of heat transfer surface) has been constructed out of thin water-wettable plastic and operated with a pressure drop of less than 0.1” of water. A gained output ratio (energy reuse) of 11 has been demonstrated with this unit [83].

Seawater Greenhouse

The Seawater Greenhouse concept couples desalination and agriculture. The design is that of a greenhouse situated near shore with opposite ends open to take advantage of prevailing winds. The wind passes through curtains of seawater falling across the openings, and is thereby cooled and humidified. At the exit of the greenhouse, the winds pass through a bank of condensers, chilled by deep ocean water. The condensate is collected for agricultural use in the greenhouse. Because the air in the greenhouse is humidified, plant transpiration is reduced, reducing irrigation requirements. The cooled air can be passed on to additional shaded greenhouse or shaded areas to aid in growing heat sensitive crops [84]. An operational prototype was operated in Tenerife during the mid-1990s. Energy requirements (for pumps and fans) are reported to be in the range of 9-23 kJ/kg of freshwater [85].

Membrane Distillation

Membrane distillation (MD) is an emerging technology for separations that are traditionally accomplished via conventional distillation or reverse osmosis. As applied to desalination, MD involves the transport of water vapor from a saline solution through the pores of a hydrophobic membrane. In sweeping gas MD, a flowing gas stream is used to flush the water vapor from the permeate side of the membrane, thereby maintaining the vapor pressure gradient necessary for mass transfer. Since liquid does not penetrate the hydrophobic membrane, dissolved ions are completely rejected by the membrane. MD has a number of potential advantages over conventional desalination including low temperature and pressure operation, reduced membrane strength requirements, compact size, and 100% rejection of non-volatiles.

A recent Sandia report discusses the application of commercial hollow fiber membrane contactors to desalination [86]. The report concludes that there are several barriers that currently prevent sweeping gas MD from being a viable desalination technology. The primary problem is that large air flows are required to achieve significant water yields, and the costs associated with transporting this air are prohibitive. To overcome this barrier, at least two improvements are required. First, new and different contactor geometries are necessary to achieve efficient contact with an extremely low pressure drop, and to improve heat recovery. Second, the temperature limits of the membranes must be increased. In the absence of these improvements, sweeping gas MD will not be economically competitive.

Mechanically Intensified Evaporation

Vlachogiannis and coworkers have proposed a process they have termed mechanically intensified evaporation [87] which couples elements of mechanical vapor compression and the Dewvaporation process. This process cycles a carrier gas (air) through the following loop. The gas is introduced into the evaporation chamber as small bubbles which rise through the brine, becoming humidified. The humid air is passed through a blower (raising the pressure), and into the condensation chamber. As in the Dewvaporation process, the condensation chamber is thermally connected to the

evaporation chamber. Due to the increased pressure, condensation occurs at a slightly higher temperature than evaporation, thus heat is flows from the condensation chamber to the evaporation chamber. The dry gas is then reintroduced into the evaporation chamber. The process can be implemented in a conventional shell and tube arrangement. The concept as demonstrated on a laboratory scale proved inefficient, consuming over 500 kJ/kg of freshwater at an operating temperature of 71 °C, and over 3000 kJ/kg at 50 °C. These results illustrate the importance of operating temperature to humidification processes, as discussed above. It is likely that improvements in the design are possible.

Atmospheric Water Vapor Processes

Atmospheric water vapor processes are those which condense water out of naturally occurring humid air, or better yet, fog. These processes have recently been reviewed by Wahlgren [88]. The idea of fog or dew water collection has been around for at least a century. It has even been speculated that the ancient Greeks used dew collection devices to produce water for the city of Feodosia. In support of this idea Zibold built a dew collector in 1912 to demonstrate the concept. It is reported that he was able to produce several hundred liters per day of water with a device approximately 20 m in diameter and a working surface area in the range of 800-1000 m² [89]. More recently, fog water collection has been practiced somewhat successfully in Chile. An average of 1900 gal /day of water was produced by 2400 m² of collection area [90].

A major factor limiting the practicality of atmospheric water vapor processes is the very low concentration of water in air (ranging from about 4 – 25 g/m³ at different locations around the world). This necessitates the cycling and cooling of even greater volumes of air than those required for “artificial” humidification processes. As with the Seawater Greenhouse, one work-around for this problem is to take advantage of the natural prevailing winds. However, Wahlgren estimated that it still requires an average of 2400 kJ of cooling for each kg of freshwater condensed. In a practical sense, this requires a large low temperature heat sink to be available, such as deep ocean water or radiative cooling to a dark night sky. Otherwise, an energy consuming refrigeration or compression cycle is generally required. Other approaches included regenerable desiccants (liquid or solid), and convective cooling in huge towers reaching hundreds of yards into the sky. Even in cases where a heat sink is available, the processes do not appear to be very cost competitive. Water produced with deep seawater coolant is reported to cost from \$5.32 to \$12.24/m³, while water from the “Rainmaker” heat pump system is estimated to cost \$47/m³. The Chilean fog water is estimated to cost between \$1.87/m³ (excluding fixed charges) and \$4.46/m³ (including fixed charges) [88].

Deep Ocean and Wave Driven Processes

A variety of processes have been developed or proposed for sea-side application. Almost all examples ultimately amount to a specially designed RO system. The two basic approaches are to capture the renewable mechanical energy of wave motion to drive to the process, or to use the hydrostatic head of the ocean to drive or assist in the process. Specific examples are described below.

Osmotic Pump

The osmotic pump is an intriguing concept that in theory could produce fresh water from the sea with no energy expenditure (other than that provided by the sun). The concept is that of a pipe capped with an RO membrane that is sunk vertically into the ocean. When the hydrostatic head exceeds the osmotic pressure, water will begin to flow through the membrane and begin to fill the pipe to maintain equilibrium across the membrane. For each increment that the pipe is sunk beyond this point, the column of freshwater must rise by a slightly greater increment, since seawater is denser than freshwater. Following this logic, if the pipe is sunk deep enough, the column of freshwater must ultimately rise above the surface of the ocean.

Levenspiel and de Nevers have examined the details of the osmotic pump, considering the extreme ideal cases of the equilibrium ocean (temperature, pressure and salt concentration are in thermodynamic equilibrium throughout) and the uniform ocean (constant temperature and salinity), and the real ocean which lies between these extremes [91]. The analysis shows that for an equilibrium ocean, one in fact can not produce freshwater at the surface. That is, one can not defy the laws of thermodynamics and get something for nothing. In essence, in the equilibrium ocean, the increase in hydrostatic head is compensated for by an increase in concentration and thus an increase in the osmotic pressure. In contrast, for a uniform ocean, freshwater would reach the surface if the pipe could be sunk to a depth of 8750 m (more than 5 miles). As a result of ocean currents, driven by energy input from the sun, the real ocean is in fact very close to uniform. Therefore, in theory, one could harvest the power of the sun through an osmotic pump. The practical realities of building such a system and then moving the water to shore are such that the osmotic pump will likely remain as theoretical curiosity.

Deep Ocean Hydrostatic Head

A step removed from the osmotic pump are those concepts which use the hydrostatic head of the ocean to drive an RO process, but supplement it with pumps to transfer the freshwater to the surface. Although energy is expended to pump the water to the surface, these systems have some potential to be more energy efficient than on-shore systems. Recall the discussion above that most of the inefficiency in RO is associated with depressurizing the reject brine. In a deep sea system, this is no longer an issue, since there is no mechanical pressurization required on the seawater side of the membrane. In addition, there is no energy expended to pump ocean water to an on-shore facility and return the excess.

The RODDS (Reverse Osmosis Deep Sea System) system, developed under the auspices of the European Union, is a recent example of the deep sea approach to RO [92] that has advanced to the stage of field testing a prototype [93]. The system is designed to operate at a depth of about 500 m, and it was estimated the energy requirement would be about 7kJ/kg of freshwater [92]. These estimates are supported by the calculations of a Japanese group that indicate a 50% reduction in power consumption for deep sea RO over land based systems [94].

Wave Pumps

The McCabe wave pump is an example of wave-powered pumping system. It was developed in Ireland, and deployed in the Shannon Estuary to provide pressurized water to an RO desalination system [95]. The primary components of the apparatus are three barges. The center barge is inertially restrained by a damping plate suspended below the barge. The forward and after barges are connected to either side of the inertial barge so that they may pitch freely in response to wave action. Pumps, powered by the relative motion of the forward and after barges to the inertial barge are positioned between barges. The system is capable of delivering 750 m³/day of water at a pressure of 70 bar in the design sea (1.5 meter waves with a 7.5 second period). The cost of purified water from this system (including the RO plant) is about \$1.85/m³.

The Delbuoy is a second example of a wave-powered pumping system designed to desalinate water via RO [96, 97]. This small system uses the motion of a buoy on the ocean's surface to pump water through an RO membrane on the sea floor and then onto shore. A test conducted off the coast of Puerto Rico in the 1980's determined that the Delbuoy could produce water for about \$5.25/m³ [98].

Waterhammer

Unsteady incompressible duct flow, also known as waterhammer, is the effect that occurs when the velocity of a fluid flowing in a pipe is changed, e.g. by the rapid closing of a valve. This rapid change in velocity creates a pressure wave which in theory can be utilized to perform useful work. Sawyer and Maratos have investigated using the waterhammer effect to capture wave energy to drive an RO desalination system [99,100] To even out pressure spikes that may damage an RO membrane, their scheme combines three existing technologies: the Tapchan wave focusing device, the Hydoram, and an RO system.

The Tapchan is simply a tapered channel that increases wave height, channeling flow into a raised reservoir. This provides a static pressure head that can be used to create a one-way flow of seawater (as opposed to the oscillating flow of the waves). The reservoir is used to drive a Hydoram, a pumping device based on the water hammer effect that produce as much as 160 times the supply head and that has been used to pump water to heights of at least 180 m. This hydrostatic head can then be used to drive an RO system. In order to reduce the hydrostatic head that must be provided by the hydoram to 110 m, the authors propose to situate the actual RO system 290 meters below ground. This would provide a head of 400m or 585 psi. In addition to providing a pressure head for the desalination, the authors propose to use the hydrostatic column above ground to pump the freshwater to the surface. The authors conclude that water could be produced by this system for \$0.44 to \$0.68/m³ (including capital costs) depending on location [100].

Nodding Duck

The nodding duck is a concept that utilizes wave motion to drive a vapor compression desalination cycle [101, 102]. The "Edinburgh Duck" is a wave absorber device with a

cam-shaped cross section that is moored with its axis perpendicular to the direction of wave travel. The point of the cam faces the oncoming wave and it nods about its axis in response to the wave. For the vapor compression cycle, the interior of the duck would be half filled with seawater, forming a fluid piston, and the chamber would be divided into two sections by a falling-film evaporator/condenser coupled to the vapor spaces by check valves. As the duck nodded through an angle of 20-60 °, the two chambers would alternately experience compression and expansion and the check valves would respond keeping the condenser side under pressure and the evaporator side under a relative vacuum. The design was never implemented, but an estimated water cost of \$3/m³ was derived from experiments with simple mock-ups.

Solar Processes

Processes driven by solar energy generally fall into two categories, those that capture and utilize the thermal energy of the sun, and those that use photovoltaic (PV) devices to generate electricity. Those utilizing thermal energy have some unique aspects and a few will be described below. Photovoltaics are typically integrated with RO units, and aside from their size and the source of electric power, have few unique features, and therefore will not be discussed further. In both cases, one of the primary limitations of solar driven desalination is the diffuse nature of the energy source, which is only about 0.6 to 1 kW/m² at 30° north latitude. This means that any solar scheme requires large collection areas to achieve significant throughputs.

Solar Stills

Solar distillation devices reproduce the hydrological cycle on a much smaller scale. The basic design of a solar still, which is similar to a greenhouse is shown in Figure 16. Solar energy enters the device through a sloping clear glass or plastic panel and heats a basin of salt water. The basin is generally black to absorb energy more efficiently. The heated water evaporates and then condenses on the cooler glass panels. The condensed droplets run down the panels and are collected for use.

Solar stills typically are less than 50% efficient, e.g. they utilize less than 50% of the incident radiation [24]. A general rule of thumb is that about 1 m² of ground will produce only 4 liters per day of freshwater [37]. Because of this, it is important to use very inexpensive materials of construction to minimize capital costs. Even so, the installation costs of solar stills tend to be considerably higher than other methods [24]. In addition the stills are vulnerable to weather damage. Modifications to the stills to increase efficiency, such as trackers to follow the sun, have generally proven to be too expensive to be practical. However, stationary stills tilted towards the sun do experience an incident energy increase of about 16%. The major energy loss from solar stills is low energy radiation from brine to the cover. Heat losses to the ground are small [24].

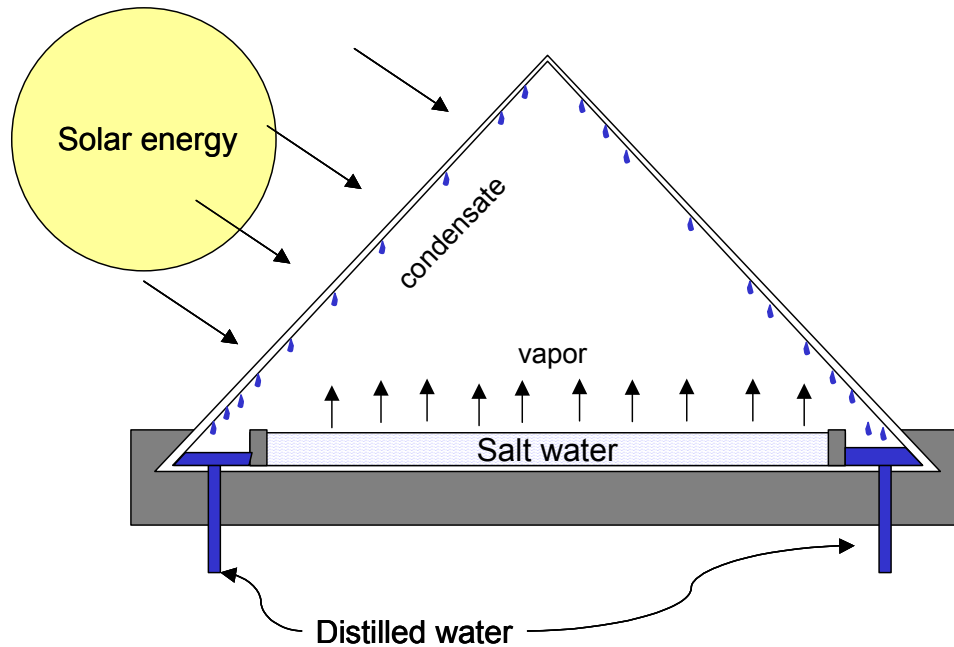

Figure 16. The basic design of a solar distillation unit.

Other Processes

A number of other processes have been described. Although they do not conveniently fit into one of the previous categories, they are all rooted in one of the three basic approaches: thermal, physical, or chemical.

Ion Exchange

Ion exchangers are organic or inorganic solids that are capable of exchanging one type of cation (or anion) immobilized on the solid for another type of cation (or anion) in solution. For example, Na^+ ions in solution can be replaced with H^+ by a cation exchanger and Cl^- can be subsequently be replaced with OH^- by an anion exchanger resulting in the complete “demineralization” of a NaCl solution. The process can be reversed by regenerating the cation exchanger with an acid, and the anion exchanger with a base. A typical ion exchanger is capable of exchanging about 5 milliequivalents of ions for each gram of solid material.

In concept ion exchangers appear attractive for desalination, since they focus on the minor component, the salt, rather than the major component, the water. In practice, ion exchange is a useful process for completely demineralizing water in applications where high purity is required, e.g. high pressure boilers. Unfortunately it is not useful for desalination in general, simply because it is cost prohibitive. This is illustrated in Figure 17 where it is assumed that NaOH and H_2SO_4 are used as the regenerative agents. The figure shows that for any initial NaCl concentration greater than about 3500 ppm, the cost of the regeneration step alone (assuming 100% efficiency) is more than \$4/1000 gallons of product, or more expensive than seawater RO (Table 4). The cost to treat seawater at

35,000 ppm would be over \$40/1000 gallons. In truth, regeneration is not 100% efficient and at least a 50% excess is usually required [103].

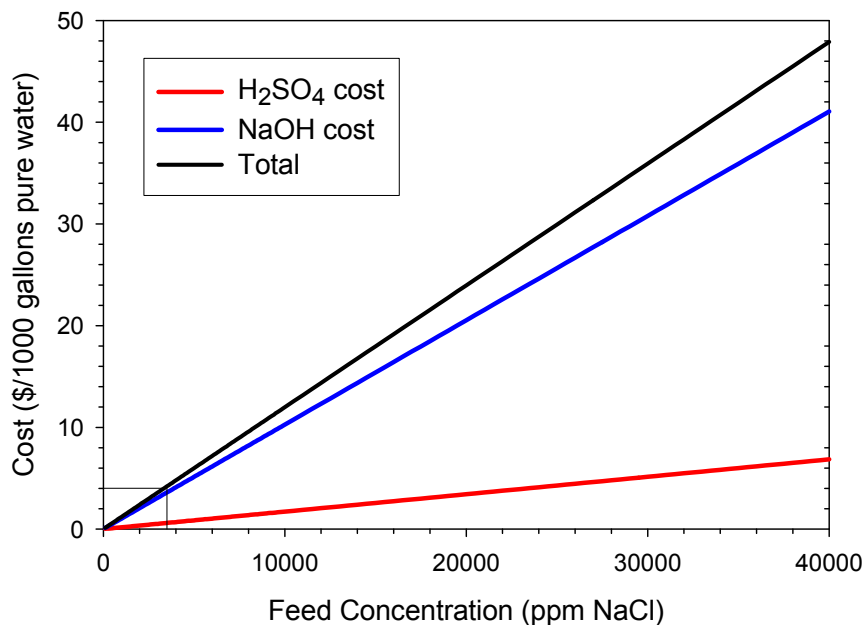

Figure 17. Cost of regenerating ion exchangers used to purify water as a function of feed concentration. Assumptions: 100% efficiency, H₂SO₄ = \$49/ton, NaOH = \$360/ton [104].

The Sirotherm process was developed in an effort to improve the economics of ion exchange for producing drinking water from brackish water [105-111]. This process involves the use of weakly basic and acidic ion exchangers that can be regenerated by hot (90 °C) water. This is possible because the dissociation of water into H⁺ and OH⁻ at 90 °C is roughly 30 times that at ambient temperature. The target of the process was to reduce 2000 ppm water to drinking water levels (500 ppm), and this was in fact achieved. However, batch operation proved to be uneconomical [108], and continuous contacters proved to be too complex for large scale operation [111]. In order to overcome some of the difficulties of continuous operation, a magnetic form of the ion exchange resin beads was invented and used to desalt groundwater on the pilot scale. The process was estimated to have lower capital costs for large plants (5-10 Mgal/day) and comparable or lower operating cost for feed salinities up to 2000 ppm [110, 111]

Flow Through Capacitor

The flow through capacitor [112] is somewhat similar in approach to electrodialysis in that it relies on the migration of ions in response to an electric field to desalt water. However, the capacitor does not rely on membranes. Rather, the ions are collected on electrodes made of a high surface area material such as carbons that can provide as much as 150 Farads per gram. The voltage is kept low to prevent electrochemical reactions from occurring. During the purification cycle, the salt solution flows between the electrodes. When the capacity of the electrodes is exhausted, flow is stopped and the capacitor is discharged, rejecting the ions back into a now concentrated solution. Energy efficiency is increased by discharging the capacitor more often thereby lowering the

maximum voltage that must be applied to the capacitor during the cycle. The energy required to purify a solution of 500 ppm of sea salt to the 25 ppm level is reported to be only 2.5 kJ/kg (0.7 kWh/m³), similar to that of electrodialysis [112]. For seawater the energy expenditure is reported to be about 38 kJ/kg, indicating that the process is less efficient than RO [113]. In theory however, this could be improved by running a greater number of shorter cycles, and by implementing energy recovery schemes, e.g. by using the discharge cycle to partially charge a second capacitor. One potential advantage of the flow through capacitor is high recoveries since the process has been claimed to be capable of processing supersaturated solutions [114].

Liquid-liquid Extraction

The Puraq process for desalination is a liquid-liquid extraction scheme utilizing polyglycol terpolymers with block configurations [115, 116]. The scheme involves contacting salt water with the solvent to form two phases, a polymer phase containing dissolved water, and an aqueous phase in which the polymer is insoluble. The distribution coefficients are such that the salts prefer to be dissolved in the aqueous phase. Hence, successive washing can lower the salt content in the polymer phase to some pre-determined level. Once the polymer phase is salt free, it is recovered and heated so that it phase separates in to a polymer phase and an aqueous phase. The aqueous phase is recovered as the product, and the polymer is recycled. Because of the lower temperature operation, and lack of an evaporation step, the process is expected to be more thermally efficient than a distillation process. Published cost estimates for the process range from \$0.28/m³ for a system closely coupled to a power generator, to \$0.43/m³ for a stand alone system [116]. These figures have not been verified by a pilot or full scale facility, and appear to be overly optimistic.

Centrifugal RO

One possible method of reducing the energy consumption of RO desalination is to use centripetal acceleration to provide the pressure head required for the separation [117]. In addition to energy savings, centrifugal RO may reduce particulate fouling [118, 119] and concentration polarization [119, 120]. A schematic of a centrifugal RO system is provided in Figure 18. The system is composed of a group of conventional RO membrane cartridges positioned at the periphery of a spinning rotor. Pretreated seawater enters the system along the axis of rotation at low pressure. As the seawater flows into the membrane cartridges it is pressurized by the acceleration of the rotor. As freshwater is produced it can be collected in a housing surrounding the device. The concentrated brine then flows back towards the axis of rotation and is rejected at low pressure. Since the seawater enters and exits at low pressure, the energy of compression is effectively recovered without the use of an auxiliary turbine or pressure exchanger. A 10 m³/day prototype system has been installed on a Canadian Naval vessel [117, 120]. The energy consumption of a 100,000 gpd system operating at 20% recovery is estimated to be 14 kJ/kg [117].

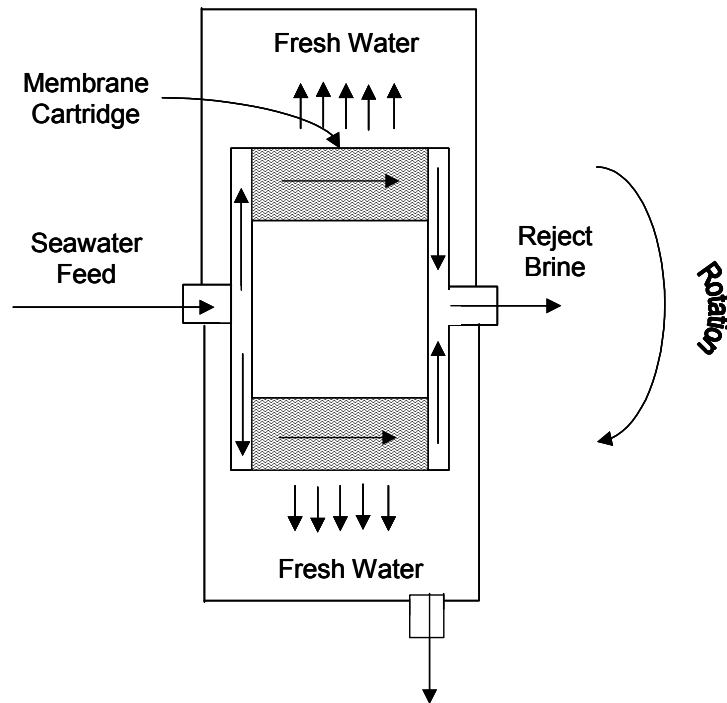

Figure 18. Schematic of centrifugal RO scheme. Adapted from [117].

Rotary Vapor Compression

Like centrifugal RO, rotary compression stills also seek to capitalize on centripetal forces. In this case, the incoming sea water is fed near the center of a rapidly rotating heat transfer surface. The rotation spreads the feed into a thin film, resulting in very high heat transfer rates. The evaporating water is withdrawn and compressed by a blower so that it condenses on the opposite side of the heat transfer surface. This approach may have advantages for small operations. Energy consumption for a pilot unit was relatively high at 67 kJ/kg [24].

Challenges and Opportunities

Thermal Processes

All thermal distillation processes have one notable Achilles Heel, and that is the large amount of energy it takes to evaporate water (about 2200 kJ/kg) compared to the theoretical minimum energy required for desalination (3-7 kJ/kg). This disparity means that to even approach the theoretical minimum would require one to recover and reuse the thermal energy input to the system hundreds of times. Clearly this is not possible in any practical system (there would be a huge number of stages each operating with incrementally small temperature differences, and thus large heat transfer areas, making the overall size of the system enormous). Scale formation is a related issue in that the solubility of calcium scale formers (e.g. calcium sulfate) decreases with increasing temperature. As discussed above, to some degree, high top brine temperatures are

desirable for distillation processes because the vapor pressure of water roughly doubles for every 10 °C increase in temperature.

Due to their relatively inefficient use of energy, and advances in RO and other competing technologies, large scale distillation processes such as MSF are unlikely to capture a large fraction of the future desalination market. To the extent that they are used, the focus will increasingly be on new designs that increase the gain ratio, i.e. the energy efficiency, without sacrificing operability, e.g. due to scale deposition on heat transfer surfaces. A primary method for achieving this will be reducing the operating pressure (and therefore the boiling temperature) of each successive stage. MEE designs are clearly a step in that direction. New, less costly corrosion-resistant materials, such as those proposed for installation in California will be a welcomed advance [53]. However, it is important to remember that distillation technologies are very mature (> 50 years) and is likely that any advances at this point will be incremental. The now standard practice of integrating power production with MSF plants may also point to a future trend. Fresh water could become such a valuable commodity that virtually all large industrial processes that are advantageously located could seek to utilize their low grade and waste heat to generate water. This could generate a niche for specialized designs to couple with new and existing facilities.

Mechanical and Thermal vapor compression processes have currently found a niche for smaller operations where simplicity and reliability are important. While typically more energy efficient than MSF and MEE, they still appear to be at a disadvantage compared to RO. However, these types of systems could fairly readily be adapted for coupling with other facilities, particularly those that generate low to medium pressure steam. As for the larger scale systems, future improvements will probably be incremental, based on optimizing the energy efficiency, while avoiding scale formation and other operational difficulties such as mist elimination, and perhaps developing custom designs to integrate with existing facilities.

There is also probably only a very limited future for large scale solar distillation, except possibly in very remote areas where fuel is expensive, land is cheap, and solar incidence is high. The reason for this is simply that compared to other systems, the energy flux available from sunlight is extremely small. In addition, most practical designs consist of only a single stage, using the heat only once before rejecting it to the environment. These factors necessitate extremely large collection areas, and hence significant capital investment. On the other hand, small scale drinking water systems are extremely simple to operate, and could very well find widespread use in developing and underdeveloped parts of the world. Systems coupling solar distillation with greenhouse cultivation (where evaporation and transpiration losses can be minimized) may also be of interest in some of these regions, although capital costs may be prohibitive. As water shortages become more critical, a domestic market could also develop for smaller systems, for example to aid in treating and recycling household gray water. Improvements will most likely be based on improving (simplifying) manufacturing to decrease costs, and improving the materials and construction so that the devices can stand years of exposure to the natural environment.

Due to the inherent inefficient use of energy, other distillation approaches are also likely to achieve only limited niche market acceptance. For example, membrane distillation might be employed in specialized systems where size and weight are primary considerations. Another possibility is that technologies are hybridized to address specific problems and situations. For instance, membrane contactors might be integrated into a vapor compression system to achieve specific size and weight requirements, or as an approach to mist elimination, although they may well introduce other problems such as pore plugging.

Humidification processes are essentially distillation processes, and thus inherently separate water from salt in an energetically inefficient manner. In addition to the thermal energy, humidification processes, particularly those operating at lower temperatures, also require energy expenditures to circulate large volumes of air. Thus, they are very unlikely to find any application in the future, except in very special situations, such as the use of solar or low grade waste heat, where thermal energy costs are extremely low, but capital costs are high. Adding air circulation to solar distillation process (or any related process using low grade heat) can allow the recovery of some of the heat for reuse, increasing the output, and thus possibly decreasing the unit's size and associated capital costs. The Dewvaporation process is essentially based on this proposition. However, it is essential that pressure drops be kept to an absolute minimum, as the electricity required to power the blower can easily approach that required to operate an RO system (In special cases where feeds have a high membrane fouling potential, humidification processes may still be advantageous. One potential solution, albeit with limited application, is to design systems that take advantage of natural convection or prevailing winds to provide the air circulation as in the Seawater Greenhouse concept.

Processes that “mine” water from the atmosphere are in some sense solar driven humidification processes that utilize the oceans as well as surface waters and plants as the collector. At first glance, since the air is already humidified, and since condensation is an exothermic process, these processes may appear to be energetically favorable. In reality there are two major limiting factors, the first being the very low concentration of water in air (ranging from about 4 – 25 g/m³ at different locations around the world [88]). This necessitates the cycling of even greater volumes of air than those required for “artificial” humidification processes. Second, useful work can only be extracted from the condensation, provided that a lower temperature heat sink is available. In the absence of this, work must actually be put into the system so that the heat can be rejected, e.g. through a refrigeration or compression cycle. These two factors suggest that systems to collect atmospheric water vapor have a very limited future. Aside from very specialized emergency or military applications that may arise, only designs that capitalize on naturally available heat sinks (for example the ocean, or radiation into the night sky) and air movement appear to have any chance of being energetically and economically viable. The seawater greenhouse, for example, employs both natural air convection, and ocean water cooling.

Freezing processes are similar to atmospheric water vapor processes in that the primary phase change is an exothermic process. However, it is also similar in that it is a process that occurs at subambient temperatures and thus requires work to be performed to transport the heat. The latent heat of freezing is only about 334 kJ/kg, a relatively small value compared to the 2200 kJ/kg required for evaporation. This suggests that freezing processes have the potential to be more efficient than distillation processes, even accounting for the required conversion of thermal energy into shaft work. Of course for maximum efficiency, the freezing and melting processes must be coupled in a regenerative fashion. In addition, freeze desalination processes should have advantages of less scale and corrosion to contend with. In addition, the technology currently exists to carry out refrigeration, even to cryogenic temperatures, on a very large scale. Facilities which condense oxygen out of the air are a good example. Freezing processes have been commercially applied as a method of concentrating waste water streams [121,122], and food [123]. The principle difficulty in freeze desalination is the added complexity of solids handling (particularly if you compare the technology to RO), and the requirement to wash the ice crystals free of entrained salt. Many of these problems appear to be circumvented for operations capitalizing on the natural freeze-thaw cycle. Unfortunately opportunities to apply this approach are limited.

The gas hydrate processes show some promise, but several hurdles remain. The most significant problem appears to be the complexity of solids handling. Improvements in crystal size and topography are needed to simplify this operation. In addition, new clathrate formers might offer improvements in operating temperature (higher) and pressure (lower).

Physical Processes

RO is currently the state of the art technology for desalination, and most of the foreseeable growth in desalination capacity will utilize RO. As such, RO is the standard by which other technologies must be judged, and is also the subject of much of the effort focused on improving desalination. Given this prominence, a number of resources aimed at identifying research needs for desalination in general, for example [22] and [55], contain significant content specific to RO. In general the recommendations fall into two categories: membrane improvements, and increased energy efficiency. The recommended improvements in membranes most commonly relate to membrane life and reductions in fouling. Improvements in the rejection of low molecular weight compounds are also desired.

There are at least two approaches that are discussed for reducing biofouling. The first approach is the development of membranes that resist the adhesion and accumulation of biofilms. The second approach is to develop membranes that are more resistant to degradation by chlorine so that feeds streams could be chlorinated to kill organisms such as algae without diminishing the membrane life. Membranes that resist scale formation are also desirable and could be used to increase recovery rates while decreasing the consumption antiscalant agents.

A number of improvements are recommended for increasing the energy efficiency of RO. The need for improved methods of energy recovery, especially for small systems, is often cited. In addition, membranes that maintain high flux rates with lower pressure differentials are desired. Decreasing concentration polarization at the membrane surface, for example by adopting flow geometries or other methods to reduce the boundary layer, could help accomplish this task.

The electrodialysis process and its cousin the flow through capacitor are currently only economical for relatively dilute solutions due to the fact that energy demands are a function of solution concentration. Unless this limitation can be addressed, these technologies will only contribute marginally to the growth in desalination. Energy recovery schemes appears to be most feasible with the capacitor arrangement, e.g. through coupled or oscillating systems. For ED, many of the improvements in RO membranes will likely also be applicable to ED. However, these improvements will do little to increase the energy efficiency. Improvements to decrease polarization phenomena could help in this regard.

Like the solar processes, the wave driven and deep ocean processes have limited applicability, are capital intensive, and are subject to environmental degradation. As result they are likely to have only regional impacts at best.

Chemical Processes

Of the three general approaches, chemical processes are the least likely to have a major impact on the desalination market, barring a major breakthrough. Ion exchange is an excellent technology for producing a high purity product, but indirectly requires the production of acid and base which is energetically and capital intensive. Other chemical schemes for trapping or precipitating ion face a similar challenge – the application of high value chemicals to produce a relatively low value product, water. One possible strategy to overcome this hurdle, is the production of a secondary, higher value product from the recovered salts. A limitation of his strategy is that the production rate of the secondary product is directly tied to rate of water production. Therefore plant operators have little leeway in responding to market forces impacting the secondary product.

The thermal regeneration approach to ion exchange (Sirotherm) is an interesting alternative, but it currently appears to be limited to low concentration (brackish) feed streams. In addition, the process is mechanically complex. This appears to largely be the result of the fact that batch thermal operations (heating and cooling a column of a solid ion exchanger) are inefficient. Although it is possible that low grade or waste heat could be applied to such an operation, MEE appears to be a less complex, more versatile, and market ready application for this resource. Similar arguments can be applied to the Puraq liquid-liquid extraction process. The process is complex, unproven on a large scale, and requires thermal input that may be better utilized in another fashion.

General Issues

There are several issues facing desalination, that are independent of the particular approach or process. As discussed above, waste disposal, i.e. the fate of the reject brine, is major concern, particularly for inland desalination operations [54, 55], and may be limiting the growth of the industry [21]. As such, efforts to critically assess the actual impact of concentrates on the environment would be an important contribution to the cause of desalination. Another potential contribution would be to find beneficial uses for the concentrate such as the recovery of valuable product, or wetland habitat development. As discussed above, one limitation of this approach is the link between the production rate of brine and freshwater. The development of salt-tolerant crops and other plant species has also been suggested as a possible approach to dealing with brine disposal issues.

There also a number of policy issues that have been identified. In particular, it has been noted that there are very few tools, and no standard methods for comparing and making decisions about different options for providing drinking water. It has been suggested that such a framework is needed and should include the elements of integrated resource planning, a cost-benefit analysis, and a sensitivity analysis that can be used to guide technological improvements [55]. In a similar vein it is often stated that the value of water differs from the cost of water. Methods are needed to better understand the current and future value to society in of using water in different ways. Suggested considerations include food security, water reliability, the impacts of water quality, the minimum requirements for human health, the value of discretionary , recreational, and environmental uses, and the value of various commercial uses [55]. Although sure to be controversial, this type of information could be used to establish water rate structures more commensurate with value.

References

1. G.F. Leitner, *Int. Desalination and Water Reuse Quart.* 7 (1998) 10.
2. R. Engelman, R.P. Cincotta, B. Dye, T. Gardner-Outlaw, J. Wisniewski "People in the Balance: Population and Natural Resources at the Turn of the Millennium" Population Action International, Washington, D.C. (2000).
3. Maude Barlow and Tony Clark in Blue Gold, New Press, New York, 2002.
4. Agence France-Presse/Associated Press, September 12, 2002.
5. Fortune Magazine, May 15, 2000.
6. A good telling of the strange and cautionary story of Fritz Haber can be found in Prometheans in the Laboratory: Chemistry and the Making of the Modern World by Sharon Bertsch McGrayne, McGraw Hill, New York, 2001.
7. I.A. Shiklomanov in Water in Crisis: A Guide to the World's Fresh Water Resources, P.H. Gleick, ed. Oxford University Press, New York, 1993.
8. S.L. Postel, G.C. Daily, P.R. Ehrlich, *Science* 271 (1996) 785.

9. *World Bank*. 1992. *World Development Report 1992*. New York: Oxford University Press.
10. M. Falkenmark, C. Widstrand, Population and Water Resources: A Delicate Balance, *Population Bulletin* 47(3), Washington D.C., Population Reference Bureau, 1992.
11. Data compiled by *Population Action International* and made available on their website at www.populationaction.org.
12. F. Roudi-Fahimi, L. Creel, R-M. DeSouza “Finding the balance: Population and Water Scarcity in the Middle East and North Africa” Population Reference Bureau Policy Brief, (2002). Available as a pdf file at www.prb.org.
13. S. Postel, Last Oasis: Facing Water Scarcity, W. W. Norton & Company, New York (1992).
14. W. Viessman Jr., M.J. Hammer Water Supply and Pollution Control, 6th ed., Addison Wesley Longman, Menlo Park, CA (1998).
15. W. B. Solley, R.R. Pierce, H.A Perlman “Estimated Use of Water in the United States in 1995” U.S. Geological Survey Circular 1200 (1998).
16. USGS Water-Use Fact Sheet. Available at water.usgs.gov/watuse/wufactsheet.html.
17. See for example The Freshwater Imperative: A Research Agenda, Naiman, Magnuson, McKnight, Stanford, eds., Island Press, Washington D.C. (1995).
18. Marq De Villiers, Water: The Fate of Our Most Precious Resource, Mariner Books, Boston (2000).
19. G.H. Wolff and P.H. Gleick in The World’s Water: The Biennial Report on Freshwater Resources 2002-2003, P.H. Gleick, ed., Island Press, Washington, DC (2002).
20. “Survey of U.S. Costs and Water Rates for Desalination and Membrane Softening Units” U.S. Bureau of Reclamation Desalination and Water Purification Research and Development Program Report No. 24, July, 1997.
21. G.F. Leitner, *Desalination* 102 (1995) 199.
22. S. Martella, ed. “Growing the U.S. Water Supply Through Purification Technologies Workshop” U.S. Bureau of Reclamation Desalination and Water Purification Research and Development Program Report No. 56, May, 2000.
23. K.S. Spiegler, Y.M. El-Sayed, *Desalination* 134 (2001) 109 and Y.M. El-Sayed *Desalination* 134 (2001) 129.
24. K.S. Spiegler and Y.M. El-Sayed, A Desalination Primer, Balaban Desalination Publications, Santa Maria Imbaro, Italy (1994).
25. S.A. Kalogirou, *Desalination* 138 (2001) 137.
26. Standards are available at www.epa.gov/safewater/consumer/2ndstandards.html
27. H.M. Ettouney, H.T. El-Dessouky, I. Alatiqi, *Chemical Engineering Progress*, September 1999, 43.
28. M.A. Darwish, N.M. Al-Najem, *Applied Thermal Engineering* 20 (2000) 399.
29. R. Semiat, *Water International* 25 (2000) 54.
30. H.T. El-Dessouky, H.M. Ettouney, Y. Al-Roumi, *Chemical Engineering Journal* 73 (1999) 173.
31. M. Al-Shammiri, M. Safar, *Desalination* 126 (1999) 45.
32. A. Al-Radif, *Desalination* 93 (1993) 119.
33. H. El-Dessouky, H. Ettouney, H. Al-Fulaij, F. Mandani, *Chemical Engineering and Processing*, 39 (2000) 343.
34. H.T. El-Dessouky, H.M. Ettouney, F. Al-Juwayhel, *Trans. IChemE* 78A (2000) 662.

35. H.M. Ettouney, H.T. El-Dessouky, I. Alatiqi, *Chemical Engineering Progress*, September 1999, 43.
36. J. DeGunzbourg, D. Larger, *Int. Desalination and Water Reuse Quart.* 7 (1998) 15.
37. O.K. Buros, "The ABCs of Desalting, Second ed." International Desalination Association, Topsfield, Mass, 2000.
38. F. Mandani, H. Ettouney, H. El-Dessouky, *Desalination* 128 (2000) 161.
39. See for example L.J. Hauge, *Desalination* 102 (1995) 219.
40. G.G. Pique, *Water Conditioning and Purification*, July 2000.
41. A. Ophir, *Desalination* 84 (1991) 85.
42. G.F. Leitner, *Desalination and Water Reuse Quarterly* 5 (1995) 24.
43. Christopher A. Houser, Scarborough College Coastal Research Group, Ontario, Canada, www.clw.csiro.au/UGD/DB/Albuquerque/Albuquerque.html.
44. Raftelis Environmental Consulting Group, Inc., 1998 Water and Wastewater Rates Survey, Charlotte, N.C.
45. Harry Cline, Western Farm Press, August 1, 2001.
46. National Resources Defense Council Fact Sheet : Alfalfa: The Thirstiest Crop, updated June 07, 2001.
47. Elizabeth Fowler, San Diego Union Tribune, June 30, 1999.
48. G.A. Pittner in *Reverse Osmosis*, Z. Amjad, ed. Chapman Hall, New York (1993).
49. R. Semiat, *Water International*, Vol. 25, 54, (2000).
50. G.F. Leitner, *Desalination and Water Reuse Quarterly* 7 (1998) 10.
51. G.F. Leitner, *Desalination* 81 (1991) 39.
52. R. Semiat, *Water International*, Vol. 25, 54, (2000).
53. D. Dean, R.P. Hammond, D.M. Eisenberg, D.K. Emmermann, J.E. Jones, H.H. Sephton, F.C. Standiford, R.E. Scott, W.J. Rider, *Desalination and Water Reuse Quarterly* 5 (1995) 19.
54. M.C. Mickley, "Membrane Concentrate Disposal" U.S. Bureau of Reclamation Desalination and Water Purification Research and Development Program Report No. 69, September, 2001.
55. "Desalination Research and Development Workshop Report" National Water Research Institute and U.S. Bureau of Reclamation, January 2001.
56. U. Petersen, *Geochimica et Cosmochimica Acta*, 58 (1994) 2387.
57. W.R. Everest, T. Murphree, *Desalination* 102 (1995) 102.
58. K. Wangnick "1998 IDA Worldwide Desalting Plants Inventory Report No. 15" Topsfield, MA, 1998.
59. G.F. Leitner, F.L. Murney, *Desalination and Water Reuse Quarterly* 6 (1998) 39.
60. Suez company website www.suez.com.
61. Suez press release August 01, 2002.
62. M. Wolfs, S. Woodroffe, *Desalination* 142 (2002) 101.
63. H.M. Hendrickson, R.W. Moulton, "Research and Development of Processes for Desalting Water by Freezing" R&D Report 10, Office of Saline Water, US Dept. Of Commerce, 1956.
64. G. Karnofsky, P.F. Steinhoff "Saline Water Conversion by Direct Freezing with Butane" R&D Report 40, Office of Saline Water, US Dept. Of Commerce, 1960.
65. H.F. Wiegandt, P. Harriott, J.P. Leinroth "Desalting of Seawater by Freezing" R&D Report 376, Office of Saline Water, US Dept. Of Commerce, 1968.

66. Dravo Corp. "10,000,000 Gallon per Day Secondary Refrigerant Desalting Plant" R&D Report PB251906, Office of Saline Water, US Dept. Of Interior, 1973.
67. W. H. Denton, *Desalination* 14 (1974) 263.
68. H.F. Wiegandt, R.L. von Berg, *Desalination* 33 (1980) 287.
69. W. Rice, D.S.C. Chau, *Desalination* 109 (1997) 157.
70. M.F. Mitkin, *Vodosnabzh I Sanit. Tekhn* 2 (1963) 24.
71. J.W. Spyker "Natural Freeze Desalination of Brackish Water – Progress Report 1972-1973" Saskatchewan Research Council Report E74-1, January 1974.
72. D.L. Stinson Canadian Patent 782,784.
73. D.L. Stinson "Atmospheric Freezing Pilot Test of Salt Removal from Big Sandy River – Colorado River Water Quality Improvement Program" University of Wyoming Report for U.S. Bureau of Reclamation contract 14-06-400-5980 4010102100, July 1974.
74. D.L. Stinson, in "Water-1976" AIChE Symposium Series (1976) 112.
75. T. Szekely "Water Purification by freezing in Dugouts – Work Done in the Season 1963-1964" Saskatchewan Research Council Report E64-10, July 1964.
76. J.E. Boyson, J.A. Harju, C. Rousseau, J. Solc, D. J. Stepan "Evaluation of the Natural Freeze-Thaw Process for the Desalinization of Groundwater from the north Dakota Aquifer to Provide Water for Grand Forks, North Dakota" U.S. Bureau of Reclamation Water Treatment Technology Program Report No. 23, September, 1999.
77. A.J. Barduhn "Desalination by Freezing Processes" in *Encyclopedia of Chemical Processing and Design*, McKetta and Cunningham, eds., Marcel Dekker, New York (1982).
78. R.A. McCormack, R.K. Andersen "Clathrate Desalination Plant Preliminary Research Study" U.S. Bureau of Reclamation Water Treatment Technology Program Report No. 5, June, 1995.
79. R.A. McCormack, G.A. Niblock "Build and Operate a Clathrate Desalination Pilot Plant" U.S. Bureau of Reclamation Water Treatment Technology Program Report No. 31, May, 1998.
80. R.A. McCormack, G.A. Niblock "Investigation of High Freezing temperature. Zero Ozone, and Zero Global Warming Potential Clathrate Formers for Desalination" U.S. Bureau of Reclamation Water Treatment Technology Program Report No. 59, June, 2000.
81. J.R. Beckman "Innovative Atmospheric Pressure Desalination" U.S. Bureau of Reclamation Water Treatment Technology Program Report No. 52, September, 1999.
82. J.R. Beckman, B.M. Hamieh, *Chem. Eng. Comm.* 177 (2000) 183.
83. B.M. Hamieh, J.R. Beckman, M.D. Ybarra, *Desalination* 140 (2001) 217.
84. Information about the design can be found online at www.seawatergreenhouse.com.
85. A.C. Paton, P. Davies "The Seawater Greenhouse for Arid Lands" presented at Mediterranean Conference on Renewable Energy Sources for water Production, Santorini, Greece (1996).
86. L.R. Evans and J.E. Miller "Sweeping Gas Membrane Desalination using Commercial Hydrophobic Hollow Fiber Membranes" SAND2002-0138, January 2002.
87. M. Vlachogiannis, V. Bontozoglou, C. Georgalas, G. Litinas, *Desalination* 122 (1999) 35.
88. R.V. Wahlgren, *Wat. Res.* 35 (2001) 1.
89. V.S. Nikolayev, D. Beysens, A. Gioda, I. Milimouk, E. Katiushin J.-P. Morel, *J. of Hydrology* 182 (1996) 19.
90. R.S. Schemenauer, P. Cereceda, *Ambio* 20 (1991) 303.
91. O. Levespiel, N. de Nevers, *Science* 183 (1974) 183.

92. D. Colombo, M. de Gerloni, M. Reali, *Desalination* 122 (1999) 171.
93. P. Pacenti, M. Reali, N. Brambilla, A. Elli, P. Helm, R. Janssen, D. Chiaramonti, S. Gartner, *Desalination* 138 (2001) 181.
94. K. Tagawa, O. Miyatake, *Kagaku Kogaku Ronbunshu* 27 (2001) 395.
95. M.E. McCormick, *Sea Technology*, December 2001, 37.
96. U.S. Patent 4,512,886.
97. DC Hicks, CM Pleass, GR Mitcheson, JF Salevon, *Desalination* 73 (1989) 81.
98. www.seagrantnews.org/news/delawar1.html
99. R.A. Sawyer, D.F. Maratos “Wavepower for Seawater Desalination Using Incompressible Duct Flow (Waterhammer)” *Proc. Mediterranean Conference on Policies and strategies fro Desalination and Renewable Energies Santorini, Greece, 2000.*
100. R.A. Sawyer, D.F. Maratos, *Desalination* 138 (2001) 307.
101. A.J. Crerar, R.E. Low, C. L. Pritchard, *Desalination* 67 (1987) 127.
102. A. J. Crerar, C.L. Pritchard, *Desalination* 81 (1991) 391.
103. C.E. Harland, Ion Exchange: Theory and Practice, 2nd Edition, The Royal Society of Chemistry, Cambridge, UK (1994).
104. Prices for bulk chemicals obtained from *Purchasing.com* magazine and *Allchem Industries* (www.allchem.com).
105. B.A. Bolto, D.E. Weiss in Ion Exchange and Solvent Extraction, Vol 7, Marinsky and Marcus, eds., Dekker, New York, 1977, 221.
106. B.A. Bolto, K.H. Eppinger, P.S.K. Ho, M.B. Jackson, N.H. Pilkington, R.V. Suidak, *Desalination* 25 (1978) 45.
107. T. Maeda, *Desalination* 23 (1977) 161.
108. P.J. Cable, R.W. Murtagh, N.H. Pilkington, *Chem. Eng.* 324 (1977) 624.
109. S.D. Haman, N.H. Pilkington, *Desalination* 28 (1979) 43.
110. B.A. Bolto, *Desalination* 50 (1984) 103.
111. B.A. Bolto, *Desalination* 106 (1996) 137.
112. *Filtration and Separation*, May 1998, 345.
113. M.D. Andelman, US Patent 6,325,907 (2001).
114. M.D. Andelman, US Patent 5,779,891 (1998).
115. L. Lazare, *Desalination* 42 (1982) 11.
116. L. Lazare *Desalination* 85 (1992) 345.
117. P.M. Wild, G.W. Vickers, *Desalination* 89 (1992) 33.
118. T.M. Fyles, D.S. Lycon, *J. Membr. Sci.* 176 (2000) 267.
119. J.G. Pharoah, N. Djilali, G.W. Vickers, *J. Membr. Sci.* 176 (2000) 277.
120. A. Bergen, T.M. Fyles, D.S. Lycon, G.W. Vickers, P. Wild, *J. Membr, Sci.* 176 (2000) 257.
121. S. Holt, *Filtration and Separation* 36 (1999) 34.
122. R. Ruemekorf, *Environmental Science and Pollution Control Series*, Dekker, New York, 1994, 513.
123. J. Chowdhury, *Chem. Eng.* 95 (1988) 24.

DISTRIBUTION:

- 20 MS 1349 James Miller, 1846
- 1 MS 9403 Bob Bradshaw, 8722
- 1 MS 0750 Patrick Brady, 6118
- 1 MS 0887 Mike Cieslak, 1800
- 1 MS 0701 Wendy Cieslak, 6100
- 1 MS 5862 Jeffrey Danneels, 0789
- 1 MS 0755 Wayne Einfeld, 6233
- 1 MS 1349 Lindsey Evans, 1846
- 1 MS 0706 Ray Finley, 6113
- 1 MS 1415 Wil Gauster, 1110
- 1 MS 1349 Bill Hammetter, 1843
- 1 MS 0755 Mike Hightower, 6251
- 1 MS 0706 Tom Hinkebein, 6113
- 1 MS 0755 Dan Horschel, 6233
- 1 MS 0759 Jim Krumhansl, 6118
- 1 MS 0703 Gray Lowrey, 6216
- 1 MS 1088 David Miller, 6134
- 1 MS 0755 Tina Nenoff, 6233
- 1 MS 1411 B.G. Potter, 1846
- 1 MS 0892 Steve Showalter, 1764
- 1 MS 0750 Malcolm Siegel, 6118
- 1 MS 0839 Maher Tadros, 16000
- 1 MS 1349 Frank Van Swol, 1834
- 1 MS 1411 Jim Voigt, 1846
- 1 MS 0735 Erik Webb, 6115
- 1 MS 0750 Henry Westrich, 6118

- 1 MS 9018 Central Technical Files, 8945-1
- 2 MS 0899 Technical Library, 9616
- 1 MS 0612 Review and Approval Desk, 9612
For DOE/OSTI

- 1 M. Kevin Price
Manager
U.S. Bureau of Reclamation
P.O. Box 25007
Denver Federal Center
Denver, CO 80225-0007