

Power Electronics Notes - D. Perreault

★★ Thermal Modeling and Heat Sinking

3 Methods of heat removal:

1. Convection: Transfer of heat to a moving fluid which takes it away
2. Conduction: Flow of heat through thermal conductor away from source
3. Radiation: Flow of heat by long-wave electromagnetic radiation.

Radiation of heat depends nonlinearly on temperature difference of source and environment (proportional to $[T_{\text{source}}^4 - T_{\text{env}}^4]$) and can be neglected in most applications.

Conduction: One dimensional heat conduction through a material can be expressed as:

$$Q = (T_1 - T_2) \left(\frac{A}{R_{th} l} \right)$$

Q is heat flow (W)
 R_{th} is thermal resistivity ($\frac{K \cdot m}{W}$)
 A is cross sectional area (m^2)
 l is length (m)

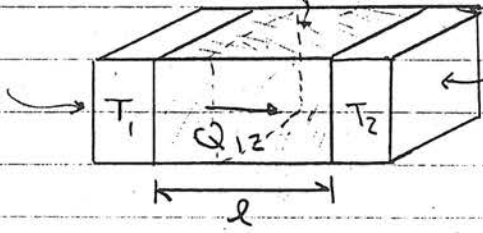

(incrementally, $q = -\frac{A}{R_{th}} \frac{\partial T}{\partial x}$)

This relationship suggests an electrical circuit analog:

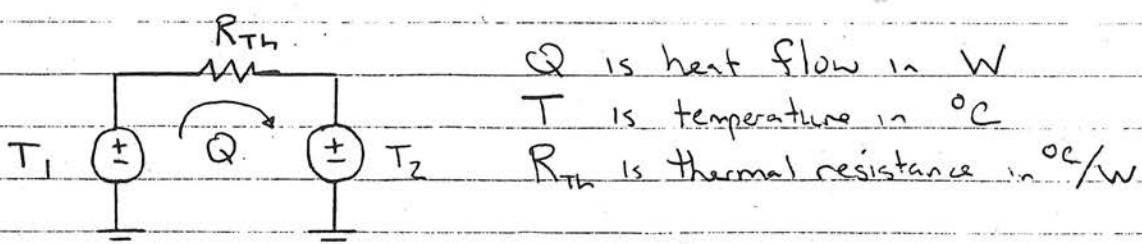

Power Electronics Notes - D. Perreault

Thermal resistance is very like regular resistance

$$R_{Th} = \frac{\rho_{Th} l}{A}$$

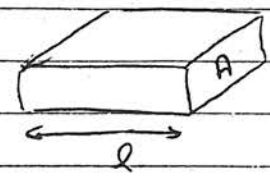

l - length of material

A - cross sectional area

ρ_{Th} - thermal resistance $\frac{^{\circ}C \cdot m}{W}$

Because of this, we can connect thermal resistances and calculate temperatures + heat flows in various series and parallel paths using simple circuit model.

Convection: convective heat transfer from a surface to a fluid in motion can be modeled as:

$$q = hA(T_{surf} - T_{fluid}) \quad \text{where } h = \text{heat transfer coefficient}$$

A = "wetted area"

Thus we can also model convective heat transfer with a thermal resistance $R_{Th} = (hA)^{-1}$

Usual Case: heat power is generated and must be removed

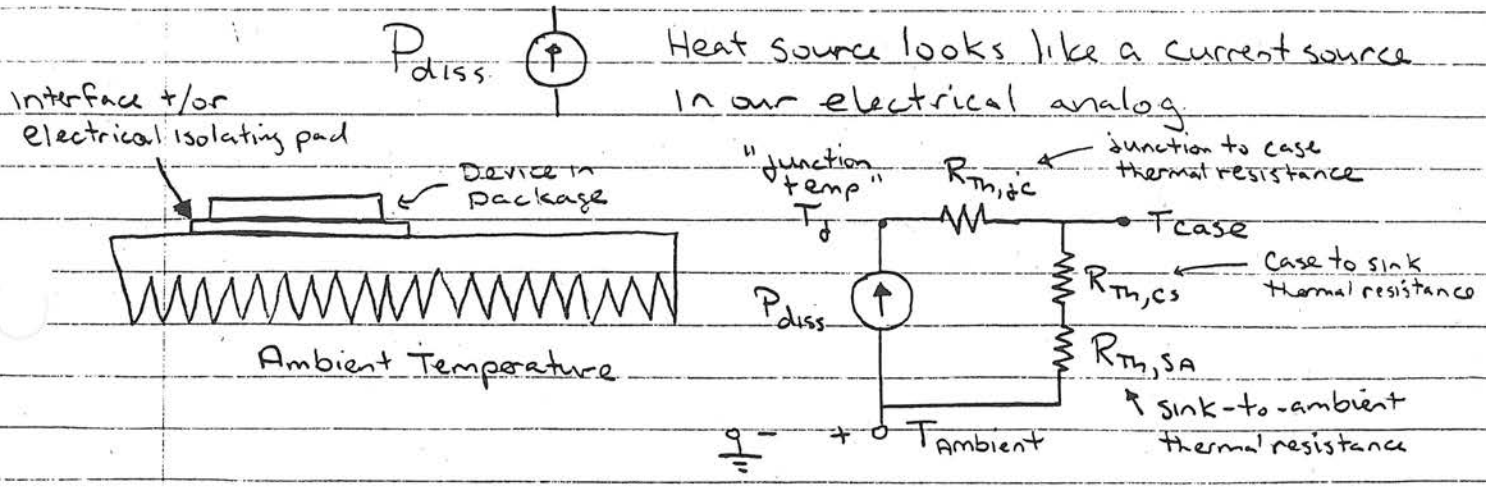

Power Electronics Notes - D. Perreault

Example :

IRF620 Mosfet in TO-220 package $R_{TH,jc} \approx 2.5 \text{ } ^\circ\text{C/W}$

$R_{TH,cs} \approx 0.5 \text{ } ^\circ\text{C/W}$

Redpoint Thermalloy KM50-1 Heat sink $R_{TH,sa} \approx 4.8 \text{ } ^\circ\text{C/W}$

So if $T_A = 40^\circ\text{C}$, $P_{diss}(\text{device}) = 10\text{W}$

$$T_j = T_{amb} + P_{diss} (R_{TH,jc} + R_{TH,cs} + R_{TH,sa})$$

$$= 40 + 10 (2.5 + 0.5 + 4.8)$$

$$= 118^\circ\text{C}$$

Typ limits for $T_j \sim 125^\circ\text{C} - 175^\circ\text{C}$ depending on device.

Note : The data sheet "current rating" or "power rating" of many devices are specified by temperature rise limits.

They usually assume the case can be held at 25°C (difficult in real life) and compute allowable current + power diss.

for $T_{j,max}$ to be reached. Hence, the IR620 is theoretically a 50W device, but this is usually impractical to achieve.

The typical design problem is : given P_{diss} , $R_{TH,jc}$, $R_{TH,cs}$, find $R_{TH,sa}$ to limit T_j or T_{case} to acceptable value.

Ex : $P_{diss} = 10\text{W}$, $R_{TH,jc} + R_{TH,cs} = 3.0 \text{ } ^\circ\text{C/W}$

$T_A = 100^\circ\text{C}$ what R_{TH} for $T_j < 150^\circ\text{C}$?

Power Electronics Notes - D. Perreault

$$T_A + P_{diss} (R_{TH,dc} + R_{TH,cs} + R_{TH,SA}) \leq T_{d,max}$$

$$\Delta T = T_{d,max} - T_A = 50^\circ C = 10 (3 + R_{TH,SA})$$

$$\Rightarrow R_{TH,SA} \leq 2^\circ C/W \rightarrow \text{buy such a heat sink}$$

Things get more complicated with multiple heat sources, such as a diode and a MOSFET on the same heat sink

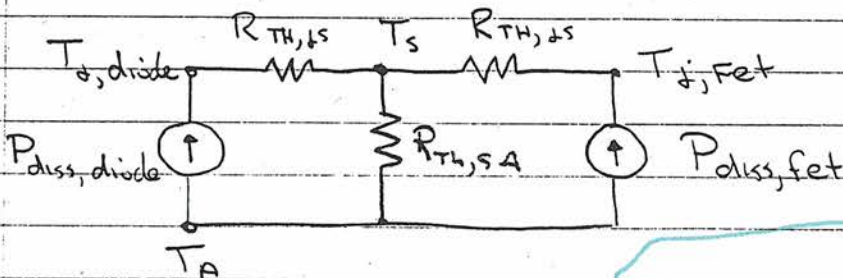

Next year:
Update notes to show general case of Thermal resistance matrix + how to use to estimate power dissipation distribution

Dynamic case: If we have pulsed power: (e.g. a UPS that runs for only a short time or a pulse discharge circuit that operates only once)

- The mass of an element can store heat energy

\therefore Thermal Capacitance C in $J/^\circ C$ $\left\{ \begin{array}{l} \text{heat capacitance in } \\ \frac{J}{^\circ C = K} \times \text{mass} \end{array} \right.$

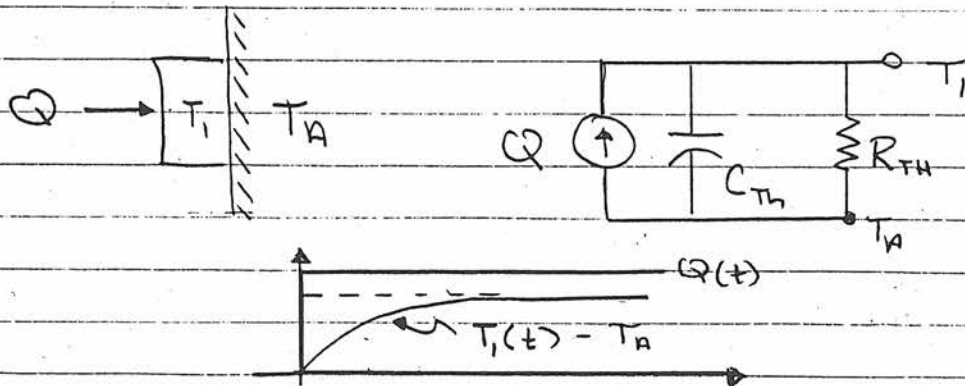

Power Electronics Notes - D. Perreault

Note: This is a lumped parameter model for a distributed system. The temperature calculated is the average temperature across the block. If we want to look over short intervals of time (e.g. $\ll R_{th}C_{th}$), at high frequency, or across small spaces, we need to use more "lumps".

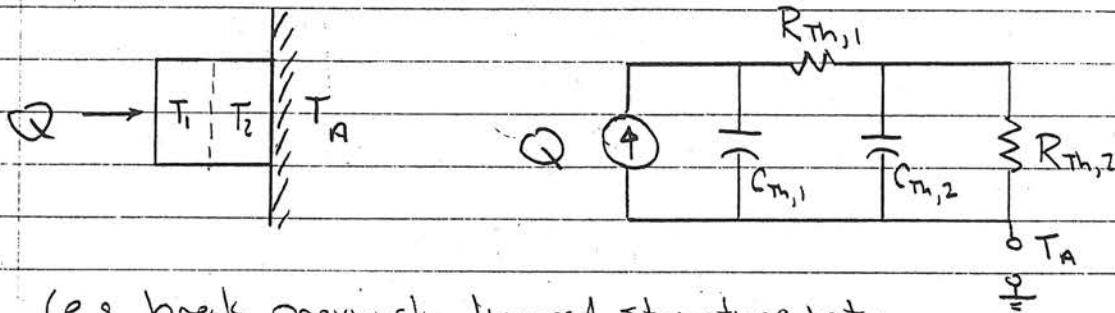

(e.g. break previously lumped structure into 2 equal lumps $R_1 C_1 = R_2 C_2 = \frac{1}{4} RC \rightarrow$ shorter timescales)

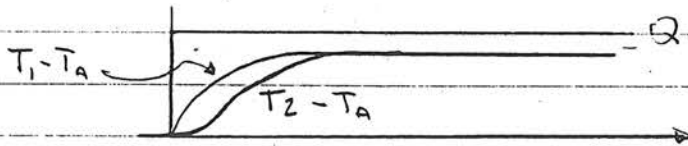

We can break the system down into as many lumps as needed. In limit, we can go to partial differential equation (distributed) representation.

PDE descriptions \Rightarrow R. Haberman, "Elementary Applied Partial Differential Equations, 2nd Ed." Prentice-Hall

Transient Thermal Impedance

To express the temp rise of a subsystem under transient conditions, sometimes a "transient thermal impedance" is used

$$Z_{th}(t) = \frac{\Delta T(t)}{Q}$$

\leftarrow Temp. rise across element
 \leftarrow magnitude of power step

So use to get $\Delta T(t)$ for steps or pulses of power. This is a reflection of the "RC" type behavior shown above

Note: Sometimes temp rise is expressed as a function of duty ratio and pulse repetition rate (of power input). This is based on similar models.

MIT OpenCourseWare
<https://ocw.mit.edu>

6.622 Power Electronics
Spring 2023

For information about citing these materials or our Terms of Use, visit: <https://ocw.mit.edu/terms>