

Cell, Vol. 113, 597–607, May 30, 2003, Copyright ©2003 by Cell Press

Development of Genetic Circuitry Exhibiting Toggle Switch or Oscillatory Behavior in *Escherichia coli*

Mariette R. Atkinson,¹ Michael A. Savageau,^{2,4}

Jesse T. Myers,^{2,3} and Alexander J. Ninfa^{1,*}

¹Department of Biological Chemistry

²Department of Microbiology and Immunology

³Program in Cellular and Molecular Biology

University of Michigan School of Medicine

Ann Arbor, Michigan 48109

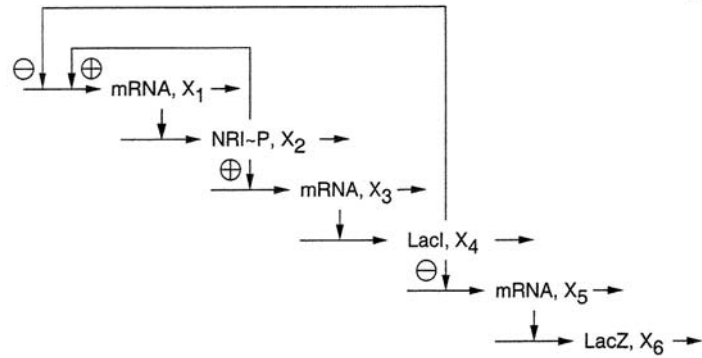
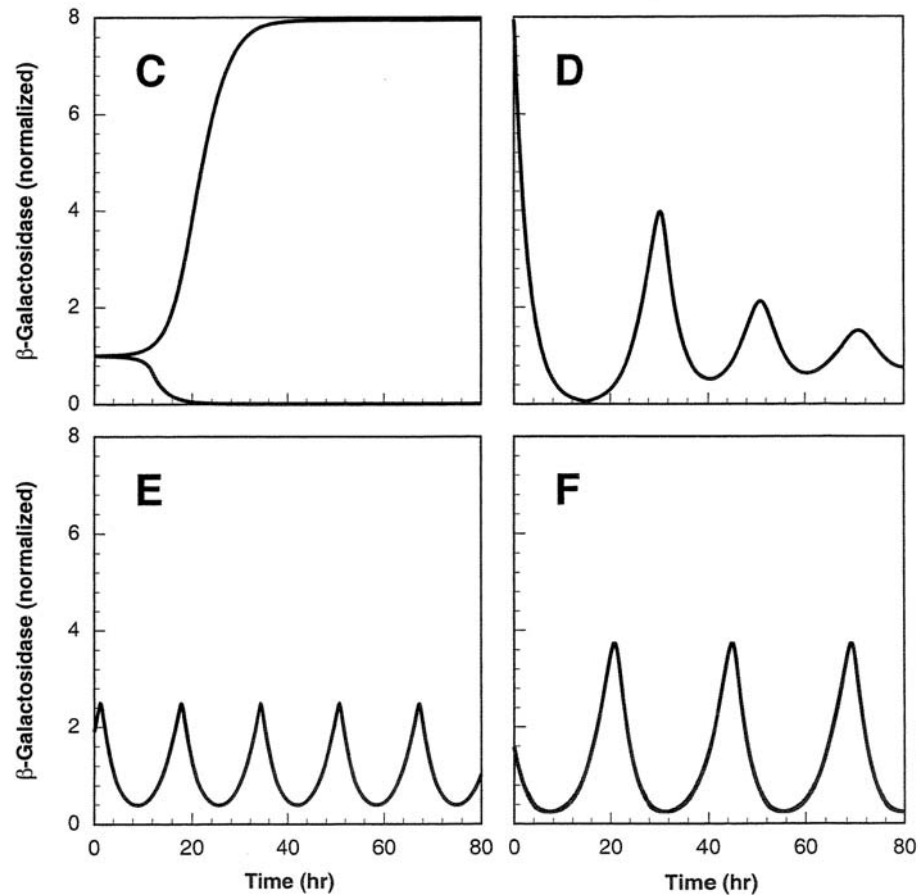
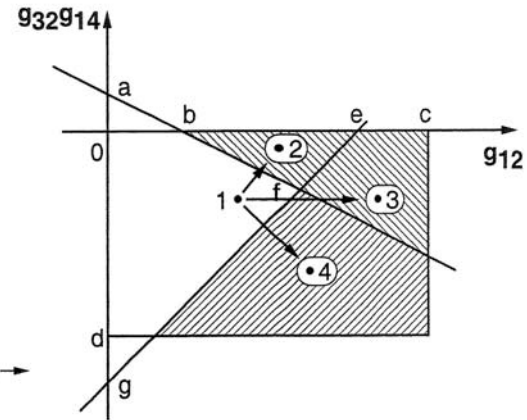
A**B**

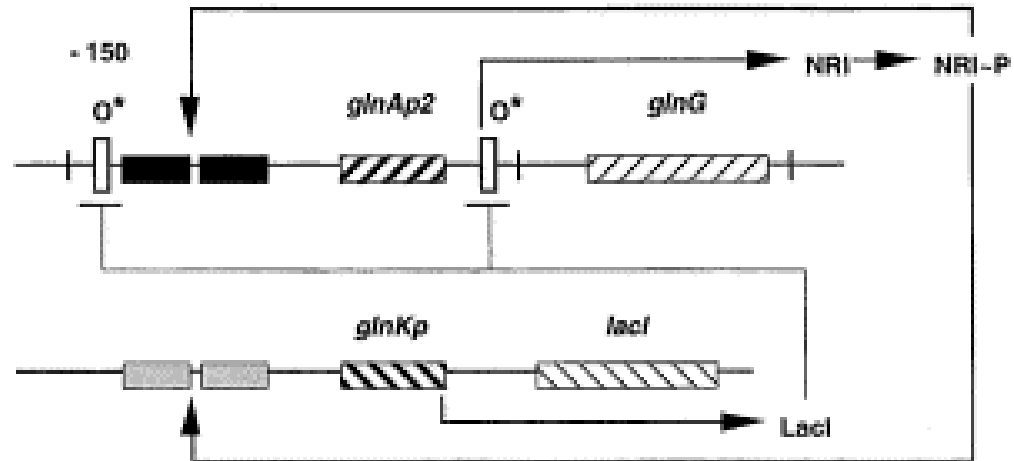
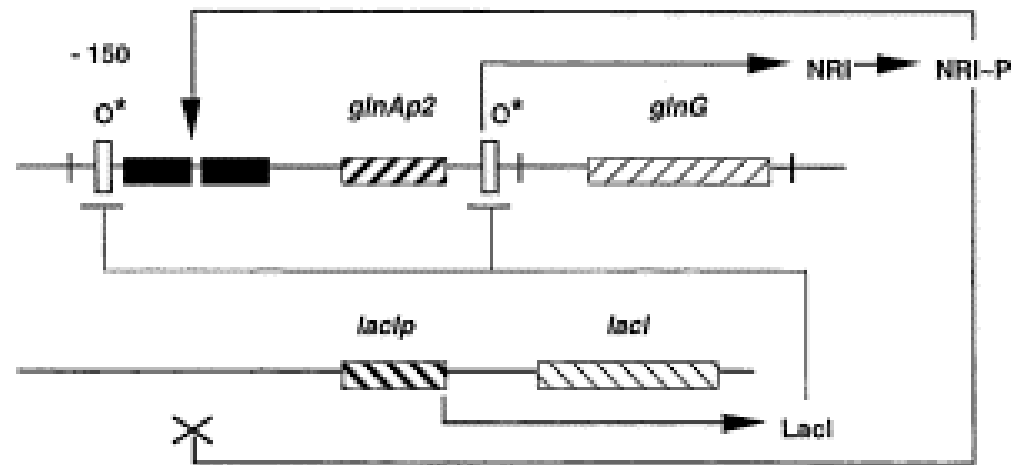
A**B**

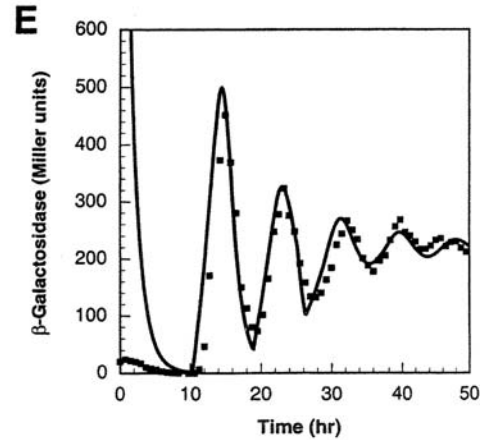
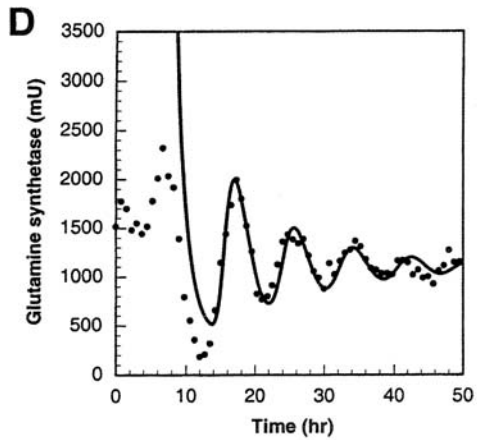
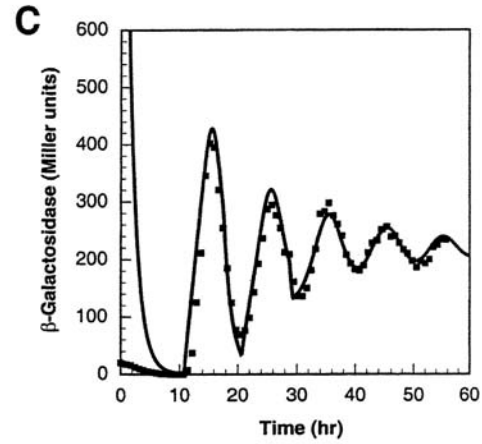
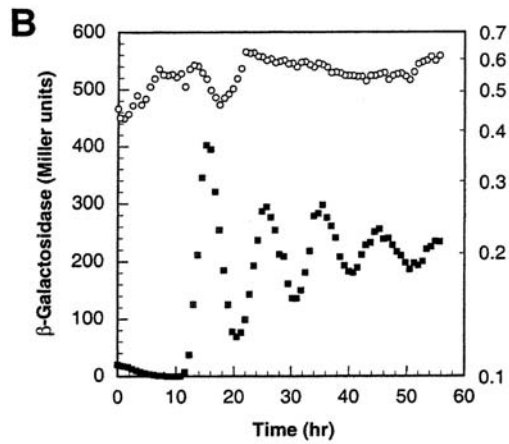
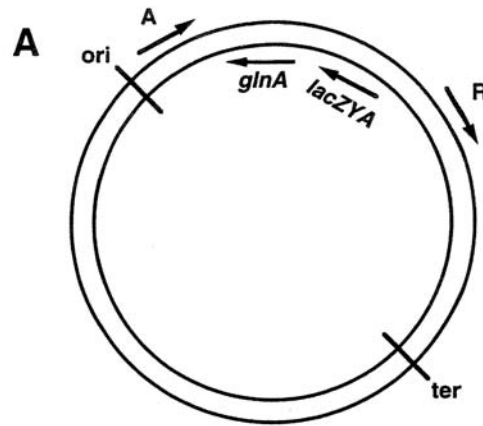

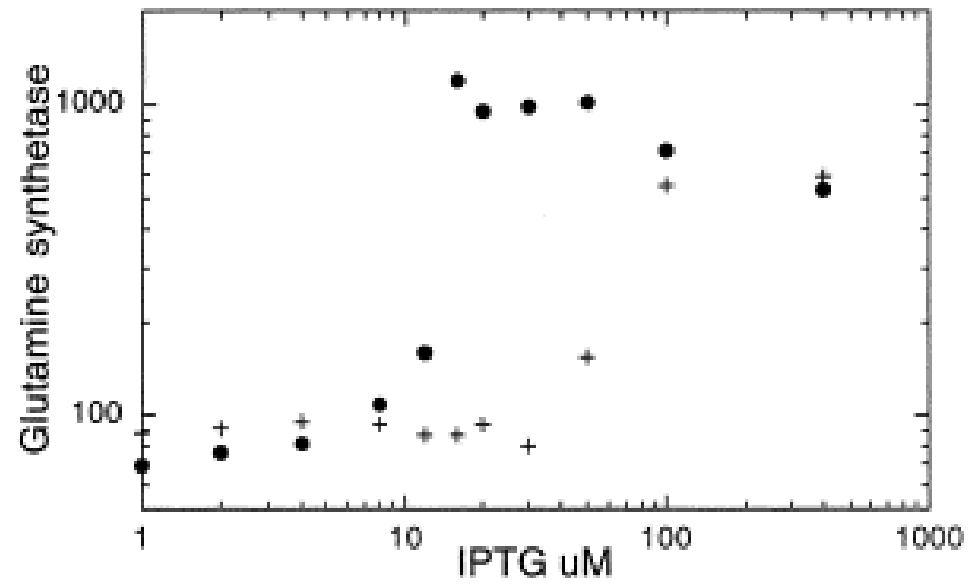
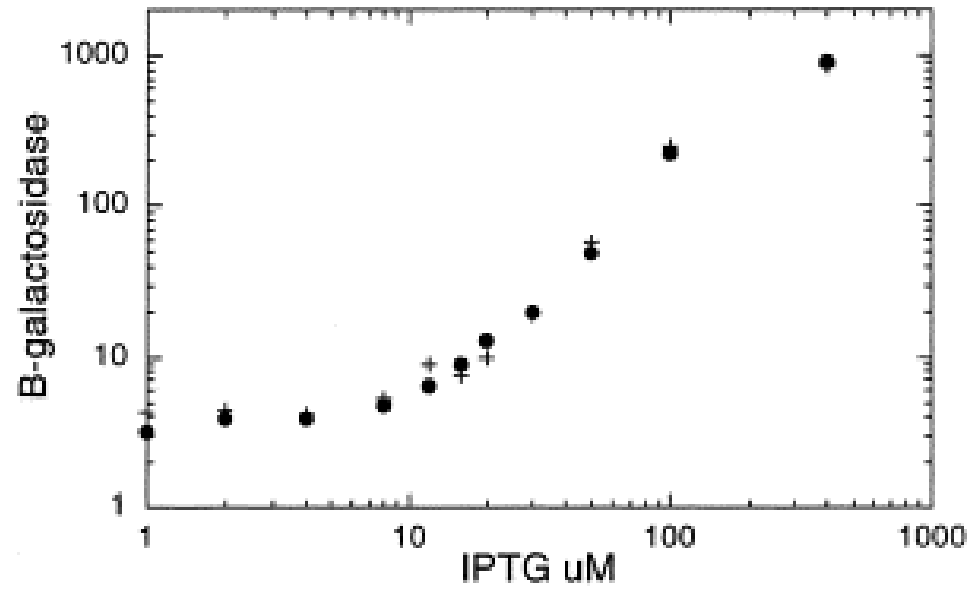

Today's goal, calculate stability diagram:

