

# Engineering, Economics & Regulation of the Electric Power Sector

ESD.934, 6.974

Session 19

Module H

## Long-term guarantee of supply in generation

**Prof. Ignacio J. Pérez-Arriaga**

### Study material

---

- I. Pérez-Arriaga, “Security of electricity supply in Europe in a short, medium and long-term perspective”, *European Review of Energy Markets*, v.2, issue 2, Dec 2007 <Introduction to power system reliability concepts>
- C. Battle, I. Pérez-Arriaga, “Design criteria for implementing a capacity mechanism in deregulated electricity markets”, *Utilities Policy* 16 (2008) 184-193 <This is the main paper you have to study>
- M. Gottstein, L. Schwartz, “The Role of Forward Capacity Markets in Increasing Demand-Side and Other Low-Carbon Resources: Experience and Prospects”, *Regulatory Assistance Project*, April 2010

## Readings

- C. Vázquez, M. Rivier, I. Pérez-Arriaga, “A market approach to long-term security of supply”, IEEE Transactions on Power systems, vol. 17, no. 2, 2002 <a precise explanation of the method of reliability options>
- International Energy Agency, “Tackling investment challenges in electricity generation”, 2007

And three papers with experiences or proposals for the application of reliability options in Colombia (*original case, in a predominantly hydro system*), Spain (*adaptation to a horizontally concentrated market*) and The Netherlands (*a much more detailed proposal that shows the intricacies of the method*)



## Outline

- **Background**
- **Basic issues in generation adequacy/firmness**
- Identifying the market failure
- Regulatory instruments



## The debate on security of electricity supply

- Who is the ultimate responsible entity?
- Should security of electricity supply be left to market forces?
- The several perspectives to be considered
  - Electricity **networks**
  - Electricity **generation**with different time scopes
  - **security** of power system operation
  - **firmness** of the installed capacity
  - **adequacy** of existing & planned investment
  - **strategic**, energy policy



## The nature of the problem & the terminology (1)

- Interlinked time perspectives:
  - – Reliability: security + **firmness** + **adequacy**
  - With a sound Strategic energy policy
- **Security**: readiness of existing generation capacity to respond, when it is needed in operation, to meet the actual load (a short-term issue)
  - Security typically depends on the operating reserves that are prescribed by the ISO
- **Firmness**: short-term generation availability that partly results from operation planning activities of the already installed capacity (a short to mid-term issue)
  - Firmness depends on short & medium term management of generator maintenance, fuel supply contracts, reservoir **management**, start-up schedules, etc.



## The nature of the problem & the terminology (2)

- **Adequacy:** existence of enough available capacity, both installed &/or expected, to meet demand (a long-term issue)
    - Is the market remuneration enough to promote the entry of generation technologies that are well adapted to the future evolution of the demand in the long term?
  - **Strategic energy policy:** concern for the long-term availability of energy resources: physical existence, price, energy dependence of the country, reliability of the internal & external energy resources, potential environmental constraints, etc. (a long to very long term issue)
- **The question:** *Can generation security, firmness, adequacy and strategic issues be left entirely to the market?*



## Outline

- Background
- **Basic issues in generation adequacy/firmness**
- Identifying the market failure
- Regulatory instruments



## Basic issues in generation adequacy/firmness (i)

- Who has the ultimate **responsibility** for the **reliability** of supply and **generation adequacy** in particular?
- Is the market **remuneration** mechanism **adequate** for the groups with highest variable costs (peaking units)?  
Can system short-term marginal prices remunerate the total costs of plants?
  - **Price caps**
    - Insufficiency of revenues from the market
  - **Uncertainty** / volatility of the market revenues
    - Risk aversion of potential generation investors
  - **Passivity of demand**
    - Small chance of contracting for these groups



## Basic issues in generation adequacy/firmness (ii)

- Is the **spot market price enough** to encourage operation strategies (maintenance scheduling, hydro management, fuel contracts) that provide acceptable firmness?
- How to avoid that any additional **economic signals** to promote investment may **interfere** with the efficient market operation?
- Should **consumers** be allowed to choose their individual level of reliability of supply?
- ¿How to complete the market so that it can **internalize** environmental costs of generation as well as the limitations in energy resources so that **energy sustainability** can be achieved? (*overlap with “strategic issues”*)



## Outline

- Background
- Basic issues in generation adequacy
- **Identifying the market failure**
- Regulatory instruments



## The heart of the matter

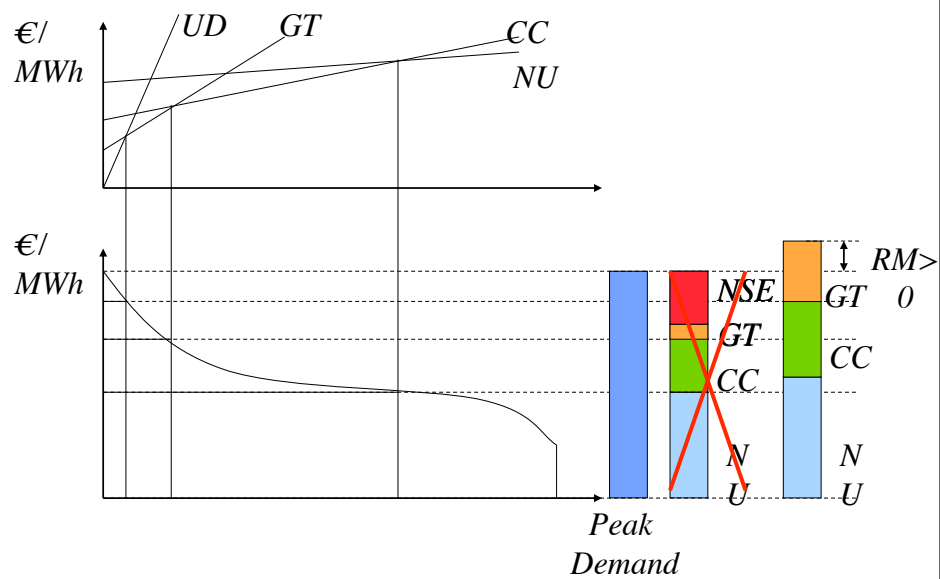

## Identifying market failures (i)

---

- Who is **responsible** for generation adequacy?
- In the traditional systems: the **regulator / incumbent utility**
  - It might not be perfectly efficient...
  - ... but capacity was finally built
- In the liberalized systems: **individual firms**
  - They make decisions in order to maximize their own profit
  - There is a strong theoretical basis showing that, under rational behavior, short-term marginal prices are enough to provide optimal decisions

**No problem up to this point**

## Identifying market failures (ii)

- But some **difficulties** arise in actual markets:
  - Price caps
    - They also cap the incentives to build more capacity
  - Risk aversion
    - Firms do not always decide to take into consideration just the mean average value of the expected profits
    - Volatile income profiles discourage investment
    - This is clearly the case of a peaking unit
      - It receives no income most of the time
      - It captures high prices when supply is tight
- Thus, the **spot market alone is not enough** to provide an adequate capacity level

Now there is a problem



## Detail (i)

- Basic economic theory
  - The power plants recover their investment costs thanks to the inframarginal profits

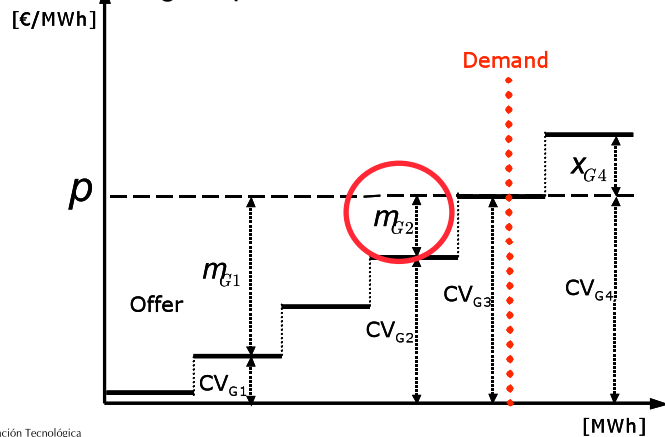



## Detail (ii)

- In energy-only markets the peaking units recover their investment costs when the prices are set by the demand or ... by using their market power during peak hours

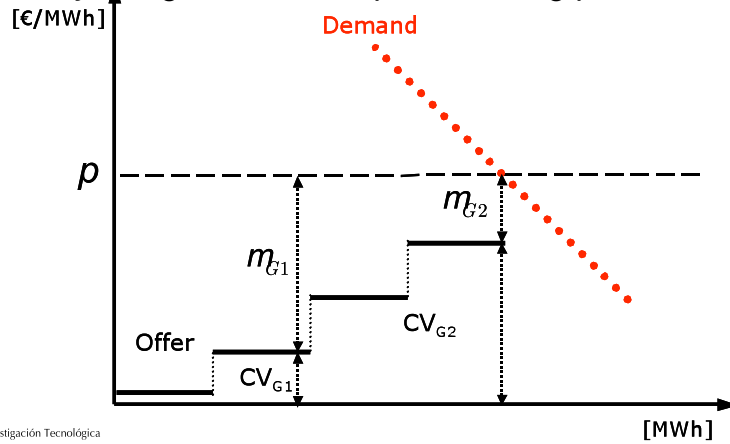

## Detail (iii)

- Two typical anomalous situations that lead to lack of investment

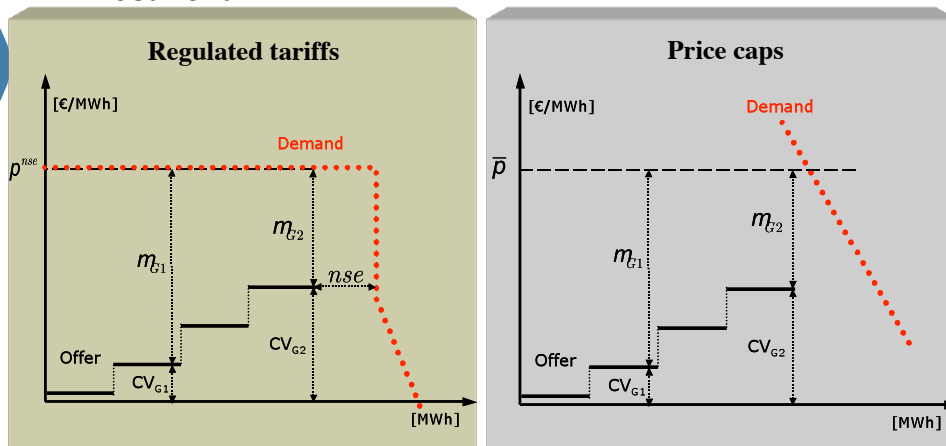

## Identifying market failures (iii)

- The risk-averse generator...
  - ... wants to be protected against **low** prices
  - ... tends to build **less** capacity than a risk-neutral one
- The risk-averse consumer...
  - ... wants to be protected against very **high** prices
  - ... would like to have in the system **more** capacity than a risk-neutral one
- Long-term contracting among them would...
  - ... **reduce the risk** of high prices for the consumer
  - ... allow the consumer to pay for the capacity he wants
  - ... diminish the risk of the generator
  - ... make attractive the construction of the peaking facilities
- A long-term market would naturally arise
  - It would fix the adequacy problem if price caps are eliminated

**Demand activity in the long-term market solves the problem**



## Identifying market failures (iv)

- Unfortunately, **actual demand** is not playing that role:
  - Regulated **tariffs** eliminate the need to protect against price spikes
  - Even the consumers that *see* spot prices often ignore reliability in their decisions
    - Some kind of *implicit insurance* is expected to be provided by the authorities and the market rules
      - ‘They will not allow blackouts to happen’
- Thus, there is a lack of demand-side response in the **long-term market**
  - Consumers are not expressing their need for a good reliability, so it is not included in the price formation
  - This creates difficulties for reliability-oriented generation to get installed

**Thus, there is a market failure**



## Identifying market failures (v)

- It is not enough to have good short-term demand elasticity
  - When a critical situation occurs, short-term demand elasticity would make self-rationing appear...
    - So the shortage problem would be alleviated
  - ... but prices would still be high
    - And consumers would also complain
- Short-term demand elasticity is generally an expensive way to provide adequacy
  - Due to risk aversion
  - And at some moment a peaking unit would be needed
- Any good solution to the problem requires some measure to reduce risk for peaking generation

**Thus, there is a market failure**



## Other issues

- Regulatory instability
  - Flawed regulations signal that regulatory changes will happen
- Imports & export commitments / firmness of contracts with external agents
- Free-riding
- In some countries the future uncertainties are really high
  - Inherent country risk premium
  - Demand increase rate is high and very volatile
  - Meteorological phenomena like “Niña” and “Niño” stress the system in difficult ways



## Outline

---

- Background
- Basic issues in guarantee of supply
- Identifying the market failure
- **Regulatory instruments**



## Basic regulatory instruments

---

- A. No intervention (“**leave it to the market**”)
- B. System Operator purchases &/or manages peaking or other generators (“**essential generators**”)
- C. Regulated competitive bidding of new generation if expected margin is considered too low (“**regulated auctions**”)
- D. Additional remuneration (“**capacity payment**” or “short-term extra payment”) to promote some extra guarantee of supply
- E. Mandatory contract cover to be assigned by market mechanisms (“**capacity obligations**”)
- F. Auction of contracts on behalf of all demand (“**reliability options**”)



## A: Leave it to the market (i)

- Motivations
    - It is simplest
    - Follows the basic principle of minimizing any interference with the market
  - Implementation
    - Do nothing (but, for the sake of consistency, also avoid price caps, let all consumers be exposed to spot prices, etc.)
  - Evaluation
    - It ignores the existence of market failures
      - risk aversion of investors
      - passivity of consumers
- and it may lead to undesirable adequacy levels



## A: Leave it to the market (ii)

- This appears to be the orthodox economic approach
  - It fully relies on market forces & learning of agents in the long-term
  - But it ignores the existence of market failures
- System adequacy/firmness are not guaranteed
  - Blackouts and high prices may happen
  - Consumers that do not hold insurance contracts may be in trouble
  - Eventually they may learn the importance of long-term hedging



## A: Leave it to the market (iii)

---

- It may require a long learning process until it functions satisfactorily
  - Very painful
    - “The baby playing near the window”
  - Market rules might probably be drastically changed before the learning process is completed
    - It has been the case in California
- Many experts consider it wise to have some kind of safety net or incentive to promote “enough” investment
  - At least as a transitory measure
- Examples: California (*initial design*), Australia, Norway, UK (NETA)



## Case examples

---

- Australia
- United Kingdom
- Norway



## Australia: Energy-only market (i)



- Australian National Energy Market (NEM)
  - Compulsory pool with energy-only market
    - Continuous trading
    - Zonal prices in the different regions
    - Prices calculated every five minutes
      - Half an hour prices
  - Financial hedges and ancillary services outside the market
  - Price cap: 6250 €/MWh
- Full retail competition with default tariffs
- Mixed supply structure: fully private (Victoria & SA) and mostly public (NSW & Queensland) generation companies

## Australia: Energy-only market (ii)



- Price spikes are a normal occurrence
  - Possibility of abuse of market power
- Market prices appear to signal new generation investment correctly (aligned with demand growth)
  - Substantial private investment in peak capacity (gas)
  - Perhaps scarce investment in base-load units (coal)
- Only a few small customer interruptions
- Prices in lower range in international comparisons
- Still more time is needed to have a solid opinion, but so far it can be considered a success

## Australia: Energy-only market (iii)



- Volatility

## NETA: Long-term reserves (i)

- NETA, now BETTA
  - Bilateral contracts + balancing ('pay as bid')
    - 95% of energy is traded bilaterally, only 5% through the balancing market
  - Introduction of "Standing Reserves"
  - Serious concern about lack of new investment (project Discovery)



## NETA: Long-term reserves (ii)

- “Standing reserves”
  - Short-term reserves bought in advance (a year ahead)
  - Demand (28%) and generation (72%) offers
  - Volume depending on the season, day and hour and allocated via a competitive tender process
  - This energy is excluded from the energy market
- Two types of contracts
  - Balancing mechanism participants
    - Balancing price + standing agreement for availability
  - Non-Balancing Mechanism participants
    - Both payments by standing reserve agreement
- 2004/2005 - 2200 MW (around 4% of peak load)
  - It could ask for more volume during the year (2005- 850 MW)



## Norway

- Energy-only market
- The market survived the crisis of the winter of 2003
  - Afterwards, a White Paper recommended to adopt some measures, mostly based on anticipated purchase of reserves
- Presently there is a week-ahead (initially a year ahead) market of operating reserves so that there are energy & reserves left after the daily spot market
  - Reserve availability is paid according to the auction
  - Any used energy is paid the balancing market price



## B: Essential generators

- Motivation
  - Guarantee a prescribed amount of installed & ready to use peak generation capacity
- Implementation
  - The System Operator purchases & manages a prescribed amount of peak generation capacity
  - This peak generation participates in the market under special rules
- Evaluation
  - Sufficient peaking capacity is guaranteed
  - It may seriously interfere with the functioning of the market
  - Not only peak capacity may be lacking
  - Some aspects in common with the tendering procedure in the new EU Electricity Directive



## B: Essential generators (i)

### B1: Peaking units bought by the SO

- The System Operator (SO) purchases &/or contracts some prescribed amount of peaking units
  - These units may be unwilling to stay in the market under the *do nothing* scheme
  - But the SO considers that they will be needed for reliability purposes in the future
  - So the SO purchases & controls them to prevent their retirement
- Examples: Sweden, Italy (*it was considered for some time*)



## B: Essential generators (ii)

### **B2: An alternative implementation** (*softer, it may not be considered an instrument to achieve adequacy*)

- The SO buys tertiary reserve in advance
  - E.g. one or several years before
  - This provides a volume of energy available to balance the system during shortages
- Examples: Norway, FERC (ACAP, proposed)
  - **The Netherlands** has selected still another alternative scheme that tries to solve the detected problems



## B: Essential generators (iii)

- These implementations only provide revenues to a few generators...
  - ... but they may reduce market prices for all
- It is not desirable to have the SO bidding his own units / energy in the market
  - Confusion of roles
  - Market results would be greatly influenced by SO actions
- The market is split into two parts:
  - The competitive one
  - The regulated peaking generators that operate outside the market



## C: Regulated auctions (i)

- Whenever the regulator considers that new investments are not appearing at an adequate pace, he calls for an auction where long-term contracts (PPA-like) are assigned
  - The auction may (or may not) include conditions on the desired type of technology, etc.
- Included in the EU Electricity Directive & in the EU Directive for security of supply



## C: Regulated auctions (ii)

- This solution does guarantee that new generation would be installed if needed
- But investors may tend not to invest in new plants unless they are awarded one of these PPAs
  - They would delay their *free* investment decisions until the regulator gets anxious and decides to call for an auction
- This may interfere much with the normal functioning of the market



## Brazil: The initial model (i)

- Brazilian market started in 1996 with a wholesale market based on:
  - Centralized economic dispatch with the variable costs of the marginal generation units as prices
  - Installed capacity about 85 GW (85% hydro)
  - Hourly average production 44 GW (95% hydro)
  - Peak demand 59 GW
  - Hydro unit of Itaipu (12.6 GW, 90 TWh, 24% Demand)
- During nine months in 2001 and 2002 rationing was imposed to all classes of consumers due to a persistent drought
  - They were forced to reduce their demand by 20%
  - Crisis & change of government: The confidence on the market was severely damaged

## Brazil: The initial model (ii)

- Distribution companies are mostly private but only 15% of the generation is private
- Prices were extremely volatile → Bad investment signal

## Brazil: Long-term contracts auctions (i)

- A two-step system based on mandatory bilateral contracts has been adopted as an incentive for new generation
  - All consumers were required to be covered by bilateral contracts (PPAs)
    - The percentage was set at 100% for distributors
  - In order to be registered, a bilateral contract must be “backed up” by “physical” production capacity on the part of the seller
    - Generators’ firm capacity is administratively determined
  - The new market design creates a system of open auctions with PPA contracts:
    - Auctions for existing energy
    - Auctions for new energy
      - Contracts for 15 years or more



## Brazil: Long-term contracts auctions (ii)

- Auctions for new energy happen 5 and 3 years ahead of delivery (“A-5” and “A-3” auctions – one of each per year)
  - Pass-through rules induce efficient contracting
- Generators must contract with all distributors, in proportion to their energy needs
- Sixty days before the auction, distributors inform energy amounts they want to contract
- Ministry of Mines & Energy offers new projects for the auction (*already with environmental authorization*), which must provide twice the energy requirements of distributors
- Investors may participate with their own projects



## D: Capacity payments (i)

- **Motivation**
  - Promote new investment and discourage retirement of capacity by an additional capacity-based payment
  - Stabilize volatile income of generators (reduce risk aversion) while reducing the market price level (extra capacity)
- **Implementation**
  - Establish level of capacity payment (global or per unit)
  - Assign payments to individual generators broadly based on contribution to system reliability
- **Evaluation**
  - Stable economic signal but risk of market interference
  - Lack of an identifiable commercial product
  - Difficulties in establishing level and assigning payments
  - No guarantee that the adequacy objective will be achieved



## D: Capacity payments (ii)

- It is a long-term payment
  - Reduces the risk...
- ... but it does not provide proper incentives for short-term operation
  - A generator may get the payment and be unavailable when the system is short
  - Detailed rules aimed to correct this issue have generally distorted the short-term dispatch of some groups and resulted very contentious
- Both the total budget and its allocation among the generators use to be contentious
  - Hydro vs. thermal
  - The case of the *junk* generators



## South America & Spain: Capacity payments

- **Motivation**

- Promote new investment and discourage retirement of capacity by an additional capacity-based payment
- Stabilize volatile income of generators (reduce risk aversion) while reducing the market price (extra capacity)

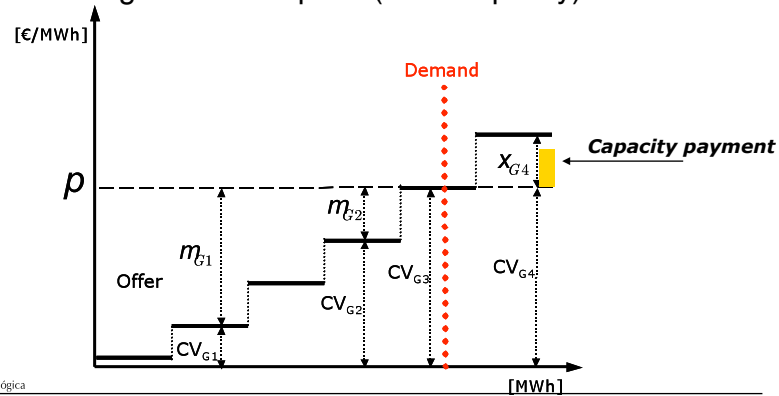

## South America & Spain: Capacity payments

- **Colombian experience** (previous to introduction of reliability options)

- Hydro production (70%-50%); Thermal (30%-50%)
- Capacity payment was about 50% of the generators' income
- Extremely volatile prices due to the “Niño” and “Niña” phenomena (frequency from 3 to 7 years )
  - From price zero to near rationing or directly rationing
  - Usual overestimation of the hydro units firm capacity
- The problem of the junk generators
  - Solved by introducing economic criteria in the firm capacity determination
- Availability was checked by random requirements to produce
  - This method introduces inefficiencies in the market
- They have changed to a new design of the capacity mechanism in 2008





## South America & Spain: Capacity payments (v)

- **Peruvian experience**
  - Hydro production (90%-70%), Thermal(10%-30%)
  - Similar uncertain weather conditions as in Colombia
  - Market design based on the Chilean electricity market
    - Centralized economic dispatch according to audited costs
    - Most of the energy is traded by bilateral contracts (90%)
  - Demand increase around 5%-10% annual
- The existing generation has evolved to a polarized mix with base load units and expensive “fuel units” (more than 200 €/MWh)
  - Market power and inframarginal benefits
  - Introduction of economic criteria in the firm capacity determination
  - The capacity payment has been useless to attract new investments, just to maintain junk generators



## South America & Spain: Capacity payments

### Spanish experience:

- About 10% of the final price of the market income
- The firm capacity is calculated administratively and the actual availability is not seriously verified
- Difficult to evaluate the effect of the method, but it has avoided mothballing old and expensive fuel units
  - Investment in new capacity seems to have other reasons than the incentive from capacity payments
  - After the stressful situation of the winter of 2002, the margin for the next five years appears to be wider, because of the investments in new CCGT & large growth of renewables



## Alternative D1: A short-term extra payment (i)

- The basic idea is to provide an extra payment in the spot market to attract new entrants
  - Implemented as a reliability adder to the spot energy price
  - The shorter the capacity margin, the higher the extra remuneration should be
- UK (before NETA)
  - Bizarre implementation: It was an energy-only mandatory pool with spot price computed ex ante
  - But the loss of load probability (LOLP) embedded in the computation of the spot price was grossly overvalued → extra income



## Alternative D1: A short-term extra payment (ii)

- The LOLP term seems easy to manipulate
  - As it has been in the UK
- This extra payment may attract some generators...  
... but it is very volatile and prone to easy manipulation → it does not really address the risk aversion problem → the additional remuneration should be very high to be effective



## E: Capacity obligations (i)

- **Motivation**
  - Guarantee a regulated adequacy target for the system and define commitments of the individual agents
- **Implementation**
  - Mandatory levels of capacity contracts to all load entities
  - ISO &/or regulator determine these levels
  - Organized long-term auctions facilitate transactions
  - Commitments may be traded in the short-term
- **Evaluation**
  - Still the firm capacities are administratively determined
  - There is an identifiable commercial product, but no commitment to help when actual shortages happen
  - The market determines the price of capacity
  - Consumers are not hedged against high market prices
  - The price of capacity may be (*has been*) very volatile



## Case example E: Capacity markets in the US (i)

- PJM, New York, New England, FERC (*proposed in SMD*)
  - Day-ahead market, locational prices calculated every five minutes resulting in hourly prices
- Motivation: “Guarantee a regulated adequacy target for the system & allocate it into commitments for individual agents”
- The regulator imposes on the demands ...
  - “Load serving entities” include eligible customers, retailers, ...
  - ... an obligation to buy a certain volume of firm capacity...
    - which depends on their estimated contribution to system peak plus a certain reliability margin
  - ... from the generators
    - whose firm capacity is also determined by the regulator



## Case example E: Capacity markets in the US (ii)

- A market appears from this obligation
  - There are organized markets, but trade is mostly bilateral
    - Vertically-integrated companies
  - The market determines the price for capacity
  - There is a product, but no commitment to produce when it is needed
    - Low penalties for generators



## Case example E: Capacity markets in the US (iii)

- Problems
  - The capacity prices are more short-term signals than long-term signals, furthermore they have price caps
    - Volatility and risk
  - Locational considerations are not reflected
    - Capacity price equal to zero and tight margin in some areas
  - Payments to units that are not really available during peak hours



## Case example E: Capacity markets in the US (iv)

- Other difficulties
  - The reliability in some isolated areas is guaranteed by old and expensive units. Since the market does not compensate for these units, two transitory cost-based methods are used:
    - “Must run agreements” that ensure costs recovery.
    - “Peaking units safe harbor” bids, some units are allowed to offer over its marginal costs to recover its fixed costs



## More recent ideas

### LICAP (Locational Capacity Market)

- This was a proposal of ISO-New England to FERC, which was meant to be implemented by January 2006 (*another method was finally chosen, see later*): LICAP
- Motivation
  - Prices from capacity markets are too volatile
    - Zero if there is excess generating capacity
    - Extremely high if there is a deficit
  - Reduce the vulnerability of capacity markets to the exercise of market power → spikes in capacity prices
  - → Use a regulated demand-for-generation-capacity curve
  - Besides, reduce the vulnerability of energy markets to the exercise of market power → generator is also subject to an option selling contract at a strike price equal to the variable cost of the peak technology



## LICAP: Locational capacity market (ii)

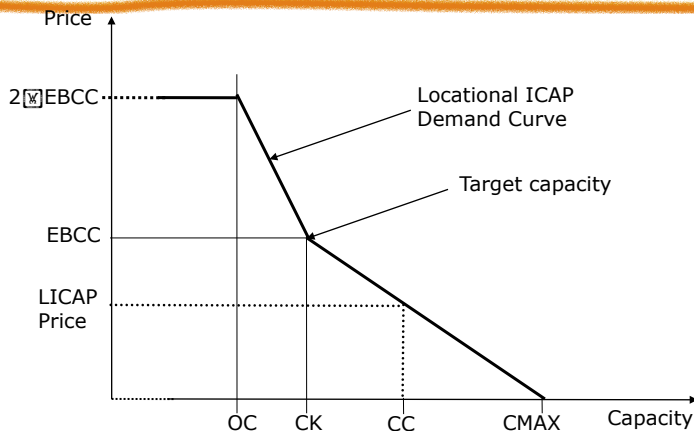

EBCC = Expected benchmark carrying cost (annualized fixed cost of frame unit)  
 OC = Capacity that exactly ensures the demand satisfaction (112%)  
 CK = Target capacity (116%)  
 CMAX = Maximum remunerated capacity (130%)  
 CC = Current capacity = installed capacity + capacity imports – capacity export



## LICAP: Locational capacity market (iii)

- Final LICAP payment = LICAP Price – “Energy Spike”
  - But LICAP payment is never negative
  - Affected by the availability in peak hours
    - If a generator is 60% available during shortages or price spikes, it earns 60% of LICAP price (always positive)
- “Energy Spike” = actual inframarginal energy rents of efficient peaker including shortage price
  - It is similar to a CfDs with a strike price equal to the variable cost of the peak unit
  - Avoids controversy of estimating energy rents
  - No incentive for supply to create real-time shortages
  - Reduced risk for investors and load



## LICAP: Locational capacity market (iv)

- The demand curve is specially designed for each area
- The payments would be allocated between the different Load Serving Entities depending on its expected demand
- Problems
  - Opponents to this method say that it will provide windfall profits to existing generators without promoting new entry
  - The administratively determined demand curve generates uncertainty
    - There will be another change of mind in the future
  - Scale problems in some of the conflictive areas
  - Transmission updates are underway, once they will be finished they will depress the prices in these zones



## LICAP: Locational capacity market (v)

- Pros & cons of this approach
  - Retaining the 'status quo' would maintain the current inefficiencies (more than 300M\$ in 2006)
  - Demand curve addresses price volatility problem
  - It could be used as a market power mitigation tool
    - But it is interfering in the short-term market



## F. The original reliability options scheme (1)

### Motivation

- Somebody (regulatory authority) **acts on behalf of the demand** and specifies the desired generation adequacy level
- **Consumers:** Obtain a well defined commercial product in return for their money
  - adequate installed capacity
  - plant availability at the time it is needed
  - a reasonable price cap whenever shortages may occur
- **Generators:** Stabilize the most volatile fraction of their revenues
- A **market mechanism** is used to determine
  - The **price** to be paid to the committed capacity
  - Each generator's **committed capacity** (how much capacity to bid is each generator' decision)



## F. The original reliability options scheme (2)

### Implementation

- The market authority buys through an auction
  - to the generators
  - on behalf of the entire demand
  - some predefined *reliability product*, a combination of
    - a financial call **option** ...
      - It gives the **buyer** the **right**, but not the obligation, to buy the electricity at a certain predetermined strike price  $k$ , instead of the spot price  $s$
      - The **seller** receives in exchange a **premium fee**  $c$ , the *call price*
    - ... **plus** a physical delivery **obligation**
      - The seller has to pay a penalty  $\mathbb{P}$  if  $s > k$  and he is not generating the committed amount of capacity





## F. The original reliability options scheme (3)

### Procedure (i)

- The regulator determines:
  - The strike price  $k$ 
    - Frontier between normal energy prices and emergency prices
    - High enough to activate only when the system is in trouble
      - In general, above the operating costs of any generator
  - The penalty  $\mathbb{P}$
  - The time horizon of the auction
  - The total amount of capacity to be bought
    - e.g. Peak demand + Reserve margin

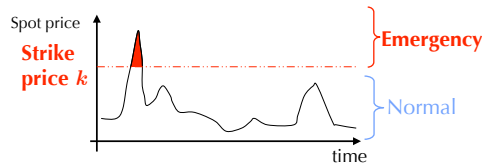

## F. The original reliability options scheme (4)

### Procedure (ii)

- Generators submit **bids**
  - **Price** (minimum premium fee required) ...
  - ... and **quantity** (capacity committed)
- For a **generator**, selling a reliability contract means a **reduction** in his **risk** and a **strong incentive to be available** during critical periods
  - Since the premium fee results from an **auction**, any unit can ask the price it needs to get installed (or to stay in the system)
  - The duration of the contracts should be large enough to stabilize the income
    - The lag period facilitates the bidding process of new entrants
      - One or two years

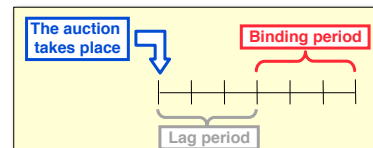

## F. The original reliability options scheme (5)

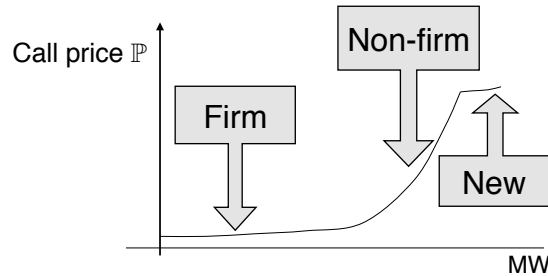

- Competition among existing energy blocks (generators) is determined by the degree of firmness (reliability) of each block and...
- ... it is not influenced at all by their operating costs



## F. The original reliability options scheme (6)

- Net income of each generator is related with its firmness
  - Equivalent to a capacity payment
  - This corresponds with some previous theoretical results

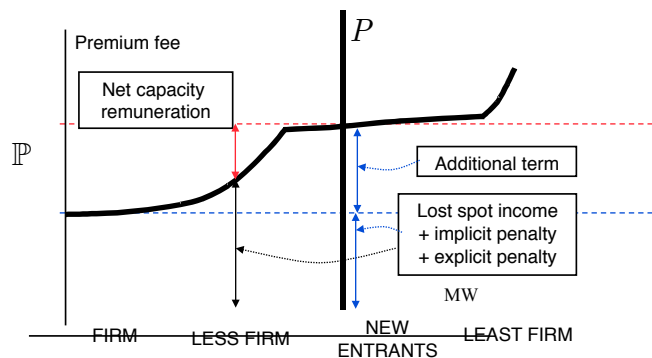

## F. The original reliability options scheme (7)

### Strong points

- Compared to the energy-only market
  - Additional incentive for new investments, since they stabilize a fraction of their income
  - Clear commitment for generators to be available when needed
  - Consumers are protected from high spot prices & their guarantee of supply improves (*although they pay for it*)
- Compared to the traditional capacity payments mechanism
  - All the previous advantages, & besides:
  - Generation capacity adequacy is guaranteed
  - No need for regulated determination of the value of firm capacity
  - Capacity payments are determined by the market



## F. The original reliability options scheme (8)

### Potential weak points (*may require some positive regulatory action*)

- The premium fee may not be enough to attract new entrants, since they would like a larger duration of their fixed payments
- Not easy to fine tune the commitment for generators to be available when needed
  - Gaming opportunities
- Potential market power abuse in the auctions
  - As in any market, but this case is more critical due to the long-lasting effects
- All consumers are protected from very high spot prices
  - It does not promote an active demand response for  $s > k$
- Capacity margin adopted by regulator & SO impacts on energy revenues for all generators



## Scheme proposed in the Spanish White Paper (i)

- Keep the present system of “capacity payments” with two major improvements
  1. The “capacity payment” now implies a commitment (*it actually becomes a “reliability option”*)
    - To produce an output equal or greater than the committed capacity “when needed”, i.e. when the spot market price exceeds a threshold (*the “strike price”*)
      - and provide the power at this strike price
    - Otherwise there will be a strong penalty
    - The regulator assigns the value of the firm capacity, although the generator may ask for a lower value



## Scheme proposed in the Spanish White Paper (ii)

(continuation)

2. A. Treatment for the presently **existing units**
  - No auction for existing units (*see 2.B for new units*)
  - **Price** is fixed administratively
    - Based on the former capacity payment (*to compensate for the depressed energy prices*) plus the cost of the new obligation
      - Opportunity costs of the option (strike sets the maximum income)
      - Expected costs of the penalties to be paid due to unexpected failures
  - **Quantity** (committed capacity) defined by the regulator
    - Generators may ask for a lower value



## Scheme proposed in the Spanish White Paper (ii)

(continuation)

### 2. B. Treatment for the **new units**

- Auctions to determine the value of capacity payments of new entrants (for 5 years) **only** if the SO foresees margin below threshold
- Every year the System Operator evaluates the expected reserve margin, looking three years ahead of time
- The auction is open to new entrants & the resulting capacity payment also applies to new existing units (*less than 5 years old*) that have not yet won an auction
- **Required total capacity** is defined by the regulator / SO, & participants decide the firm capacity they want to bid
- **Price** (*capacity payment*) is determined by the auction



## ISO NE: Forward capacity markets (i)

- This is a different version of the reliability options approach
- Strike price: heat rate of peaking unit times the fuel price (indexed): approx. US\$ 200/MWh
- Committed agents must produce (or provide reserves) in emergency situations (defined by ISO with prescribed rules)
  - Heavy penalty if failure (e.g. payment of 1 month)
  - ISO audits if new future committed agents are expected to be available at the committed time
- Every year the ISO determines the needs for new capacity, taking into account any new capacity that has been added to the system
  - ISO determines the maximum firm capacity that each agent can bid (they may bid less, but not more)



## ISO NE: Forward capacity markets (ii)

---

- Annual auctions (descending clock) for the estimated total need of firm capacity three years ahead
  - New resources get the capacity payments for 5 years; existing units have to participate in the annual auction to receive capacity payments
  - Only the resources (generation units & demand) that have participated & won in an auction are paid capacity
  - New and existing resources compete in the auction, but prices are set by new resources
  - •All resources need to be qualified by ISO to participate in the auction
  - Wind generation also participates
  - Demand has been very successful in the first auctions



---

END OF PRESENTATION



## Annex

# Detail on “reliability options”



## Reliability Options (detail) Basic guidelines

- The mechanism designed should replicate an **ideal market** where consumers and generators engage in **long-term contracts**...
  - ... reducing the risk of the peaking generators
  - ... hedging consumers against high prices
- Since it seems that this market is not arising naturally (and this is causing problems), the proposed mechanism artificially creates a **reliability-oriented long-term market**
  - It may only be a transitory procedure



## Reliability Options (detail) Basic guidelines (ii)

- The market authority buys
  - to the generators
  - on behalf of the whole demand
  - some predefined *reliability product*
- The system **authority** will be the **buyer** in this market
  - Instead of consumers, that may not be active enough in this field
  - This is equivalent to an obligation to buy imposed on consumers
  - Buying for the whole of the demand avoids free-riding problems



## Reliability Options (detail) Basic guidelines (iii)

- The reliability contracts will be allocated through an **auction**
  - Generators compete to provide the service
  - The price of *reliability contracts (capacity)* is determined by market forces
  - The allocation of these *capacity contracts* among the different generators is determined by market forces
- Market vs. administrative allocation
  - Market allocation is possible if selling a reliability contract has some cost for the generator





## Reliability Options (detail) The product

- The **reliability product** is a combination of
  - a financial call **option**
    - It gives the **buyer** the **right**, but not the obligation, to buy the electricity at a certain predetermined strike price  $k$ , instead of the spot price  $s$ 
      - If  $s < k \rightarrow$  buyer buys in the spot market at  $s$
      - If  $s > k \rightarrow$  buyer calls the option and buys at  $k$
    - The **seller** receives in exchange a **premium fee**  $c$ , the *call price*
  - plus** a physical delivery **obligation**
    - The seller has to pay a penalty  $\mathbb{P}$  if  $s > k$  and he is not generating the committed amount of capacity



## Reliability Options (detail) The product (ii)

- For a **consumer**, having the ISO buying reliability contracts on his behalf means:
  - A maximum-price **hedge**
    - The energy price he pays is limited to  $s$
    - In addition, he pays the premium fee
      - its like medical insurance
  - An availability **guarantee**
    - Sometimes it is more important to avoid rationing
    - It is not a perfect protection, but includes an economic compensation



## Reliability Options (detail) The product (iii)

- For a **generator**, selling a reliability contract means:
  - A **reduction** in his **risk**
    - He is changing a volatile and uncertain income...
      - the opportunity to obtain a higher price from the spot market
    - ... for a stable one
      - the premium fee
  - A strong incentive to be available during critical periods
    - Explicit penalty  $\mathbb{P}$
    - Implicit penalty (*payment derived from the call option*)
  - Since the premium fee results from an **auction**, any unit can ask the price it needs to get installed (or to stay in the system)



## Reliability Options (detail) The product (iv)

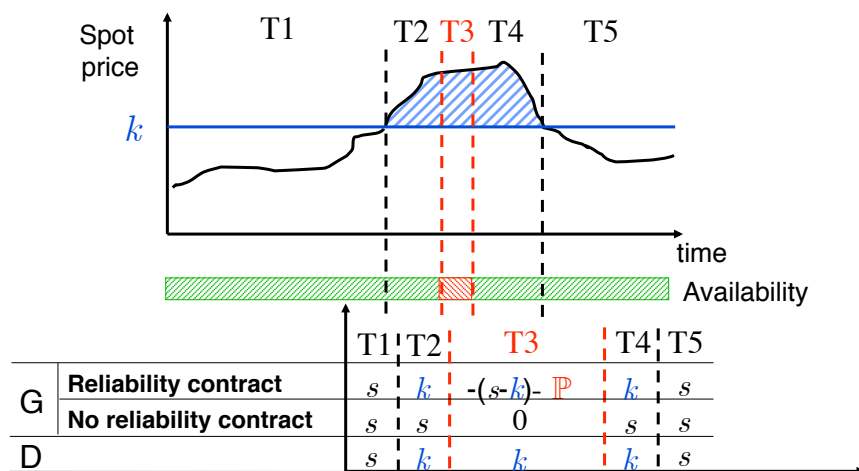

## Reliability Options (detail) Procedure

- The regulator determines:
  - The strike price  $k$
  - The penalty  $\mathbb{P}$
  - The time horizon of the auction
  - The total amount of capacity  $P$  to be bought
- Generators submit **bids**
  - **Price...**
    - Minimum premium fee required
  - ... and **quantity**
    - Capacity committed
  - (Optional) each bid corresponds to a physical facility
  - Each generator may submit various blocks



## Reliability Options (detail) Procedure (ii)

- Market clearing
  - Offers are ordered by price
  - The cheapest are selected until the total amount of capacity  $P$  is completed
  - The most expensive accepted bid sets the **reliability market price**,  $\mathbb{S}$
  - $\mathbb{S}$  is the per-unit premium fee paid to all the accepted bids
- Thus, a generator with an accepted bid of  $p$  MW
  - Always receives  $p \cdot \mathbb{S}$  (premium fee)
  - Any time  $s > k$ , pays  $(s - k) \cdot p$
  - Any time  $s > k$  and  $p^t < p$ , pays additionally  $\mathbb{P} \cdot (p - p^t)$ 
    - $p^t$  the hourly production of the facility



## Reliability Options (detail) Procedure (iii)

- Having one single strike price makes bids comparable
  - Its value is not critical
- It is the frontier between
  - *Normal* energy prices
  - *Emergency* or near-rationing prices
- It should be high enough to activate only when the system is in trouble
  - In general, above the operating costs of any generator
  - Minimum interference with energy market, since this is a regulated mechanism

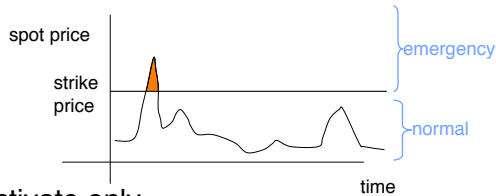

## Reliability Options (detail) Procedure (iv)

- Time frames

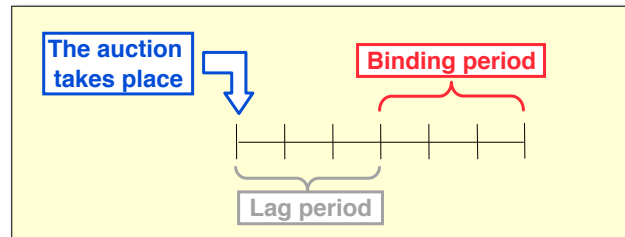

- The duration of the contracts should be large enough to stabilize the income
  - One year may be a good solution
    - Except odd hydro cycles (*El Niño*)
- The lag period facilitates the bidding process of new entrants
  - One or two years



## Reliability Options (detail) Expected outcome

- The bid price of any generator would include:
  - The value of the lost income, i.e. when the spot price goes above the strike price
    - In principle this component is the same for all generators
    - Decreases with risk aversion
  - The amount paid back to consumers when the generator is unavailable
    - The less reliable the generator, the higher it is
    - Increases with risk aversion
  - The value of the penalties to be paid
    - The less reliable the generator, the higher it is
    - Increases with risk aversion



## Reliability Options (detail) Expected outcome (ii)

- Some generators may include an additional term in their bids
  - New entrants: if their remuneration is not enough they will not go on with their investment
  - Plants potentially closing: if they do not cover their costs, they will leave the market
- This additional term would be the difference between
  - Their total market income
  - Their total costs (per year), including:
    - Operation and capital costs for the new entrant
    - Just operation costs for the plant potentially closing
- Predictability of income is critical for investors → the period for which the initial premium applies can be extended for new entrants



## Reliability Options (detail) Expected outcome (iii)

- Three typical bidding profiles (*according to the characteristics of generators*):
  - Firm energy (*very reliable generators*)
    - Most relevant component in their bid is the foregone income
    - Compensation & penalty are not significant
    - Bid should be low
  - Les-firm energy (*less reliable generators*)
    - Same foregone income, but comparatively less important
    - Compensation and penalty are very relevant
    - Price is high
  - New entrants (*typically new & reliable; other possibilities*)
    - If reliable, same as for firm energy; but now there is an additional term



## Reliability Options (detail) Expected outcome (iv)

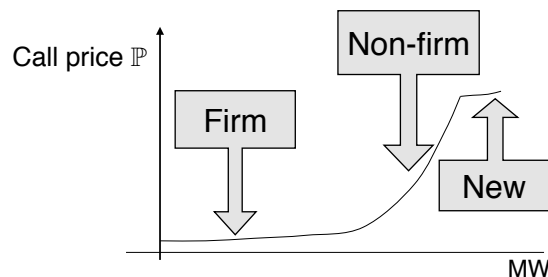

- Competition among energy blocks (generators) is determined by the degree of firmness (reliability) of each block and...  
... it is not influenced at all by their operating costs



## Reliability Options (detail) Expected outcome (v)

- Net income of each generator is related with its firmness
  - Equivalent to a capacity payment
  - This corresponds with some previous theoretical results

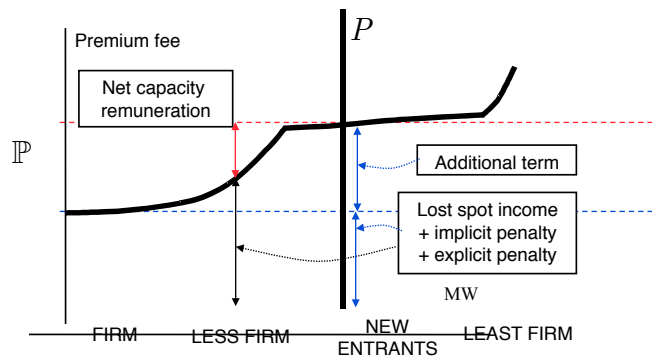

## Reliability Options (detail) Evaluation (1)

### Strong points

- Compared to the energy-only market
  - Additional incentive for new investments, since they stabilize a fraction of their income
  - Clear commitment for generators to be available when needed
  - Consumers are protected from high spot prices & their guarantee of supply improves (*although they pay for it*)
- Compared to the traditional capacity payments mechanism
  - All the previous advantages, & besides:
  - Generation capacity adequacy is guaranteed
  - No need for regulated determination of the value of firm capacity
  - Capacity payments are determined by the market



## Reliability Options (detail) Evaluation (2)

### **Potential weak points** (may require some positive regulatory action)

- The premium fee may not be enough to attract new entrants, since they would like a larger duration of their fixed payments
- Not easy to fine tune the commitment for generators to be available when needed
  - Gaming opportunities
- Potential market power abuse in the auctions
  - As in any market, but this case is more critical due to the long-lasting effects
- All consumers are protected from very high spot prices
  - It does not promote an active demand response for  $s > k$
- Capacity margin adopted by regulator & SO impacts on energy revenues for all generators



## Implementation details in different market designs

- Specific for the scheme proposed in the Spanish White Paper
  - Implementation in a context of excessive market concentration
  - Prevent gaming by potential new entrants if they expect an auction to happen soon
- Shared with other schemes
  - Determination of “firm capacity” in the presence of hydro, thermal & intermittent generation





## Implementation details in different market designs

- *(continuation)*
- Specific of reliability options in different versions
  - The definition of the “strike price”
  - The role of the “penalty” for not providing the assigned firm capacity when required
  - Determination of the values of the strike price, the penalty, the total required volume of firm capacity, the time horizon & the time lag
  - Preventing that unavailability of the required firm capacity might be hidden via successive markets
  - Implicit or explicit selection of new investment technologies via the implementation details



## Implementation details in different market designs

- *(continuation)*
- Interaction with long-term contracts
- Choice of lag period with multi-year repetitive natural phenomena
- Lack of price signals to consumers above the strike price
- Firmness of commitments by generators located in other countries
- Safeguard rules to prevent reckless behavior by generators



## In the scheme proposed in the Spanish White Paper Preventing gaming while waiting for the auctions

- Market power
  - The potential for market power in this auction depends on the horizontal concentration in the system...  
... but also on the volume of new generation that is willing to participate in the capacity market
- Stronger safeguard rules could be implemented if market power is a concern
  - The “Spanish version” of reliability options has been designed to cope with this problem



## In the scheme proposed in the Spanish White Paper Preventing gaming while waiting for the auctions

- Ad hoc rules to prevent gaming with the date of the auctions
  - The generators already installed (and not older than five years old) that have not taken part in any previous auction
    - receive for the time being the standard capacity payment
    - can take part in the auction, earning the marginal capacity price resulting from the auction until they are five years old



## In the Spanish White Paper & in other schemes The determination of firm capacity

- Strongly dependent on the system requirements ...
  - Demand behavior (seasonality, peaking)
  - Generating system characteristics
    - Key factor: share (and characteristics) of the limited energy plants
  - Firm supply = firm capacity? firm energy? a mix of both?
    - Firm supply “units” = MW, MWh or MWh\*
      - e.g. PJM, Brazil or Guatemala ( $h^*=4$  peak hours in the dry season)
- ... & on the design of the regulated capacity scheme
  - May even distort the market behavior (Argentina, Colombia)
  - The higher the capacity incentive the larger the firm capacity that generators will try to make available
    - Which is the firm capacity of a hydro plant?



## Definition of the product in reliability options The strike price

- Theoretical definition: regulatory frontier between “normal functioning” and “near rationing” conditions of the market
  - In principle, the strike price at least should equal the highest short-term marginal cost of any unit in the system
- On the generation side
  - What happens when the variable cost of a significant fraction of the installed capacity is well above the estimated (or desired) price level of rationing?
    - e.g. Peru, Guatemala
    - How to prevent free riding?
- On the demand side
  - If demand can opt-out, there is also a free riding problem
    - e.g. The Netherlands



## Implementation details in reliability options

### The lag period and the duration

- The unavoidable market intervention: implicit selection of technologies by the adopted implementation scheme
  - Observed undesirable results of implicit incentives
    - Peru and the former capacity payments
      - Regulatory uncertainty reduced the incentive to “efficient” entries
      - Just “ultra expensive” peaking units (minimum investment cost)
    - PJM Reliability Pricing Model and Spain and average valuations
      - Lack of peaking units
  - Quasi-explicit technology selection via product definition
    - Brazil and the energy call options auctions
      - Fifteen year duration contracts
      - Long-term planning model to solve the auction (considering handicaps)
    - Guatemala and the regulated competitive bidding
      - Aimed at base-load generators (strike price defined accordingly)



## Implementation details in reliability options

### Lack of price signals to consumers

- Demand
  - Mechanisms could be implemented to provide economic signals to demand during high-price periods
    - The total volume of call options  $P$  that the OS buys is broken down into pieces  $P_i$  that are assigned to every consumer/retailer  $i$ 
      - This is a minimum quantity (consumer may ask for more)
    - Whenever the spot price  $s > \bar{k}_i$ , the consumer
      - pays a penalty  $\mathbb{P}$  for its consumption above  $P_i$
      - receives a bonus  $\mathbb{P}$  if its consumption is under  $P_i$
  - It is more difficult to implement as it requires individualized load predictions for each consumer/retailer



## Implementation details in reliability options

### Firmness of commitments from external systems

- Transmission
  - The penalty  $\mathbb{P}$  also applies if the committed generation does not have the required firm transmission rights to make its generation available when  $s > k...$
  - ... but transmission availability is the responsibility of the ISO
  - For external generators
    - The same requirement of provision of firm transmission rights
- Safeguard against foreign regulations
  - Committed foreign generation capacity should not be recalled to serve its national demand under emergency conditions
    - Need to harmonize European regulations
    - Meanwhile, place the burden on the foreign generator and **make sure that the penalty  $\mathbb{P}$  can be applied**



## Implementation details in reliability options

### Safeguard rules to prevent excessive risks

- Safeguard rules
  - A number of safeguard rules can be implemented to avoid generators from taking excessive risks
  - Some of them are:
    - No portfolio bidding
    - No bids above nominal capacity are accepted from a generator
    - No secondary trading is allowed for the physical delivery obligation
    - Financial guarantees
      - Depending on a certain measure of risk exposure (for each generator) calculated by the regulator



MIT OpenCourseWare  
<http://ocw.mit.edu>

ESD.934 / 6.695 / 15.032J / ESD.162 / 6.974 Engineering, Economics and  
Regulation of the Electric Power Sector  
Spring 2010

For information about citing these materials or our Terms of Use, visit: <http://ocw.mit.edu/terms>.