

3

Signals and Systems: Part II

In addition to the sinusoidal and exponential signals discussed in the previous lecture, other important basic signals are the unit step and unit impulse. In this lecture, we discuss these signals and then proceed to a discussion of systems, first in general and then in terms of various classes of systems defined by specific system properties.

The unit step, both for continuous and discrete time, is zero for negative time and unity for positive time. In discrete time the unit step is a well-defined sequence, whereas in continuous time there is the mathematical complication of a discontinuity at the origin. A similar distinction applies to the unit impulse. In discrete time the unit impulse is simply a sequence that is zero except at $n = 0$, where it is unity. In continuous time, it is somewhat badly behaved mathematically, being of infinite height and zero width but having a finite area.

The unit step and unit impulse are closely related. In discrete time the unit impulse is the first difference of the unit step, and the unit step is the running sum of the unit impulse. Correspondingly, in continuous time the unit impulse is the derivative of the unit step, and the unit step is the running integral of the impulse. As stressed in the lecture, the fact that it is a first difference and a running sum that relate the step and the impulse in discrete time and a derivative and running integral that relate them in continuous time should not be misinterpreted to mean that a first difference is a good “representation” of a derivative or that a running sum is a good “representation” of a running integral. Rather, for this particular situation those operations play corresponding roles in continuous time and in discrete time.

As indicated above, there are a variety of mathematical difficulties with the continuous-time unit step and unit impulse that we do not attempt to address carefully in these lectures. This topic is treated formally mathematically through the use of what are referred to as generalized functions, which is a level of formalism well beyond what we require for our purposes. The essential idea, however, as discussed in Section 3.7 of the text, is that the important aspect of these functions, in particular of the impulse, is not what its value is at each instant of time but how it behaves under integration.

In this lecture we also introduce systems. In their most general form, systems are hard to deal with analytically because they have no particular properties to exploit. In other words, general systems are simply too general. We define, discuss, and illustrate a number of system properties that we will find useful to refer to and exploit as the lectures proceed, among them memory, invertibility, causality, stability, time invariance, and linearity. The last two, linearity and time invariance, become particularly significant from this point on. Somewhat amazingly, as we'll see, simply knowing that a system is linear and time-invariant affords us an incredibly powerful array of tools for analyzing and representing it. While not all systems have these properties, many do, and those that do are often easiest to understand and implement. Consequently, both continuous-time and discrete-time systems that are linear and time-invariant become extremely significant in system design, implementation, and analysis in a broad array of applications.

Suggested Reading

Section 2.4.1, The Discrete-Time Unit Step and Unit Impulse Sequences, pages 26–27

Section 2.3.2, The Continuous-Time Unit Step and Unit Impulse Functions, pages 22–25

Section 2.5, Systems, pages 35–39

Section 2.6, Properties of Systems, pages 39–45

UNIT STEP FUNCTION: DISCRETE-TIME

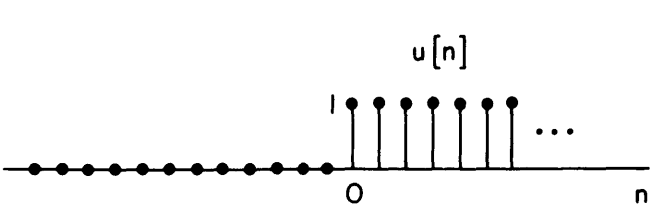

$$u[n] = \begin{cases} 1 & n \geq 0 \\ 0 & n < 0 \end{cases}$$

TRANSPARENCY 3.1
Discrete-time unit step and unit impulse sequences.

UNIT IMPULSE FUNCTION: DISCRETE-TIME

(Unit Sample)

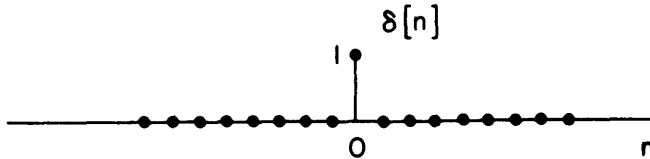

$$\delta[n] = \begin{cases} 1 & n = 0 \\ 0 & n \neq 0 \end{cases}$$

$$\delta[n] = u[n] - u[n-1]$$

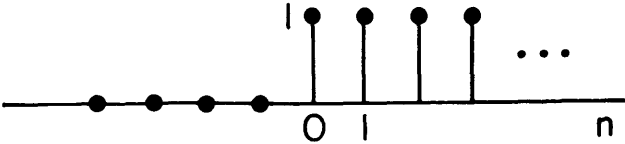

$$u[n]$$

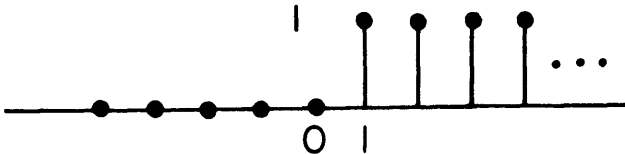

$$u[n-1]$$

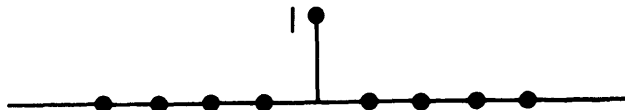

$$u[n] - u[n-1]$$

TRANSPARENCY 3.2
The unit impulse sequence as the first backward difference of the unit step sequence.

TRANSPARENCY

3.3

The unit step sequence as the running sum of the unit impulse.

$$u[n] = \sum_{m=-\infty}^n \delta[m]$$

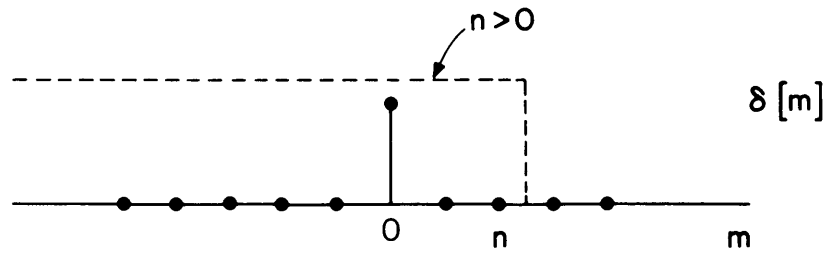
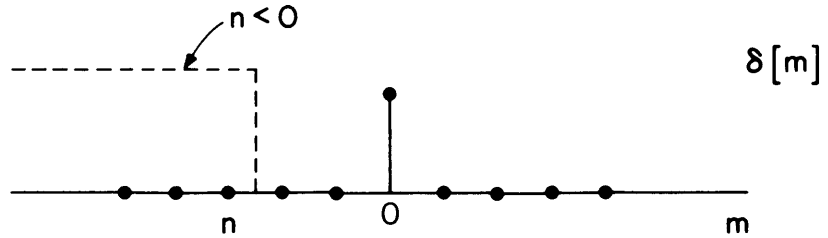

TRANSPARENCY

3.4

The unit step sequence expressed as a superposition of delayed unit impulses.

$$u[n] = \sum_{k=0}^{\infty} \delta[n-k]$$

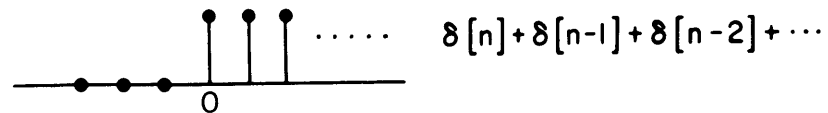
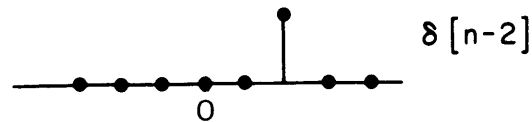
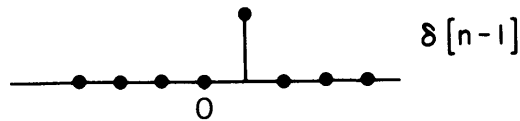
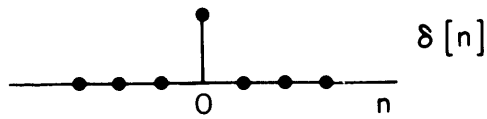

UNIT STEP FUNCTION : CONTINUOUS - TIME

$$u(t) = \begin{cases} 0 & t < 0 \\ 1 & t > 0 \end{cases}$$

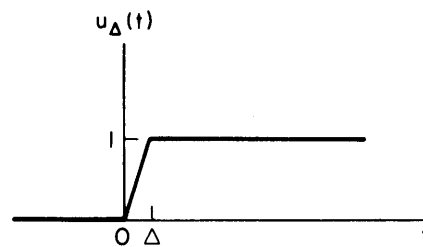
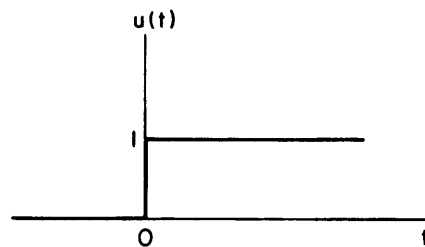

$$u(t) = u_{\Delta}(t) \text{ as } \Delta \rightarrow 0$$

TRANSPARENCY

3.5

The continuous-time unit step function.

UNIT IMPULSE FUNCTION

$$\delta(t) = \frac{du(t)}{dt}$$

$$\delta_{\Delta}(t) = \frac{du_{\Delta}(t)}{dt}$$

$$\delta(t) = \delta_{\Delta}(t) \text{ as } \Delta \rightarrow 0$$

TRANSPARENCY

3.6

The definition of the unit impulse as the derivative of the unit step.

TRANSPARENCY

3.7

Interpretation of the continuous-time unit impulse as the limiting form of a rectangular pulse which has unit area and for which the pulse width approaches zero.

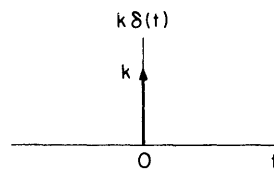
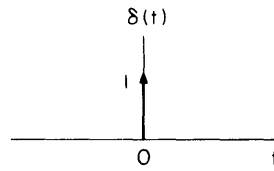
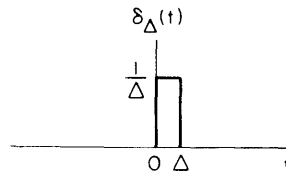

TRANSPARENCY

3.8

The unit step expressed as the running integral of the unit impulse.

$$\delta(t) = \frac{du(t)}{dt}$$

$$u(t) = \int_{-\infty}^t \delta(\tau) d\tau$$

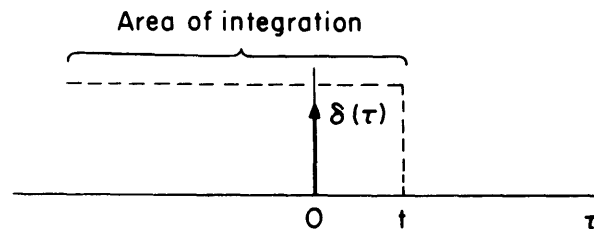
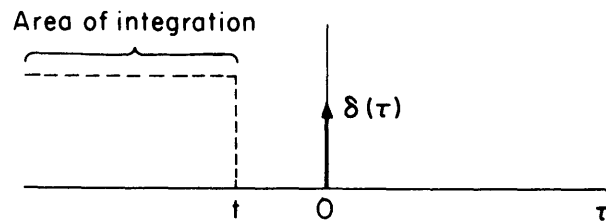

TRANSPARENCY 3.9
Definition of a system.

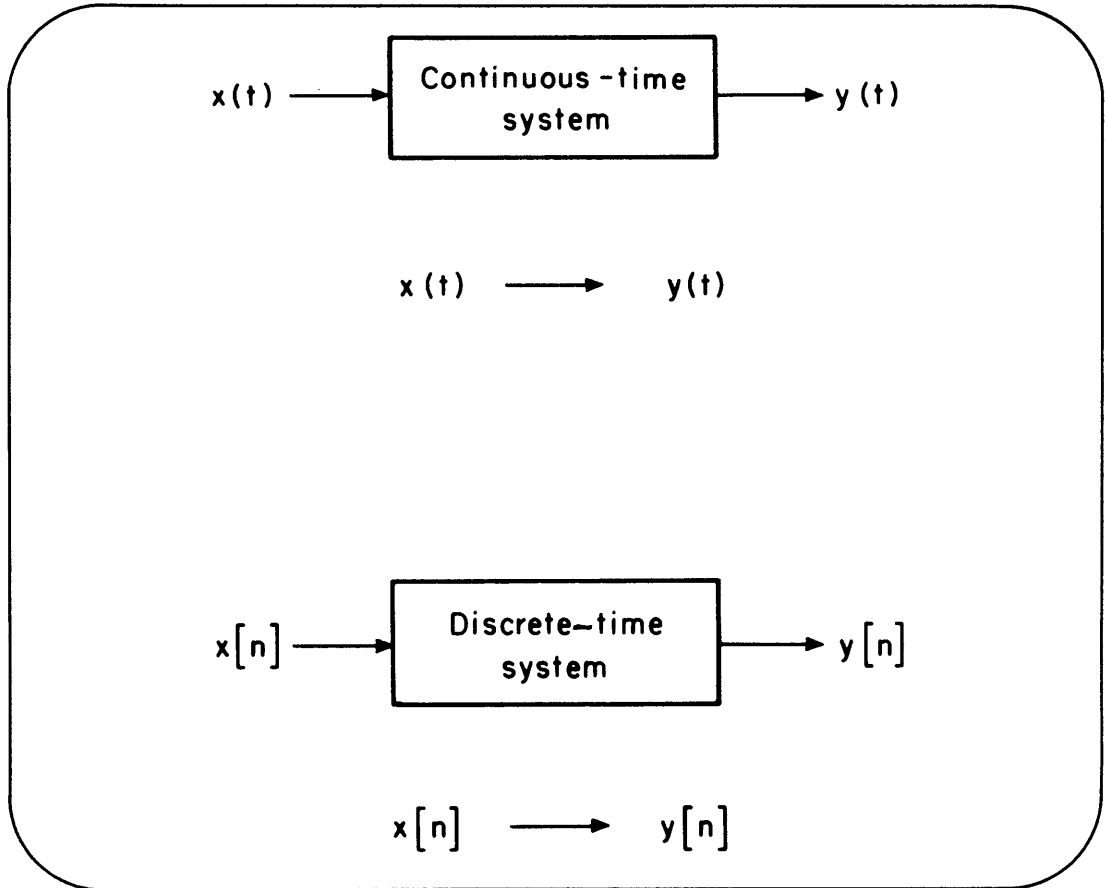

TRANSPARENCY 3.10
Interconnection of two systems in cascade.

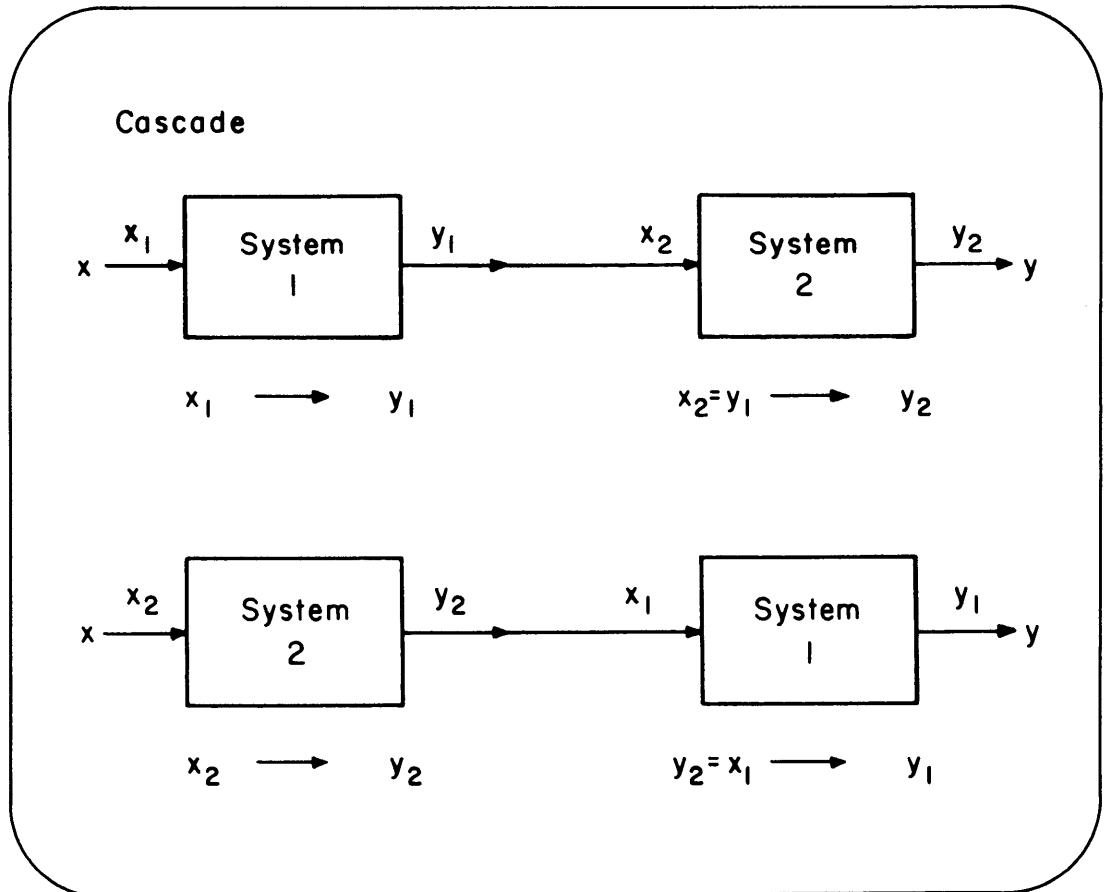

TRANSPARENCY
3.11
 Interconnection of two systems in parallel.

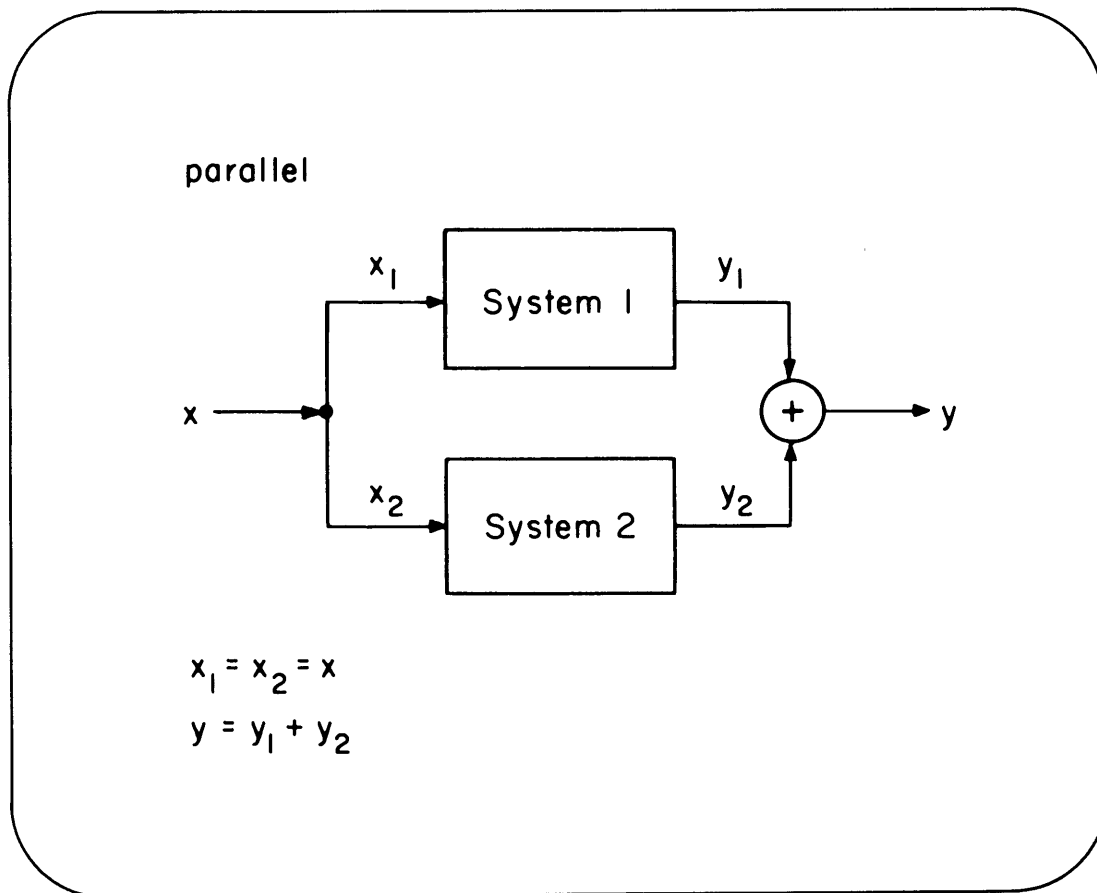

TRANSPARENCY
3.12
 Feedback inter-connection of two systems.

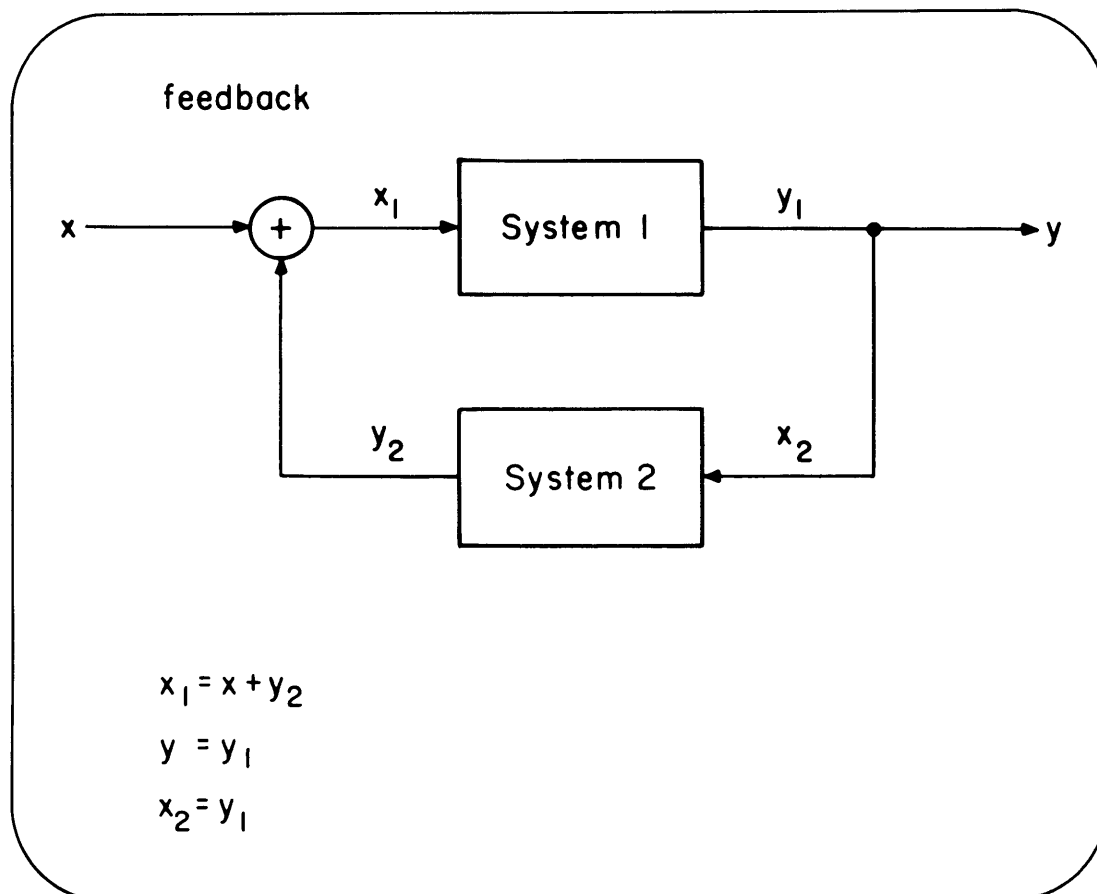

MARKERBOARD
3.1

MEMORYLESS

$$y(t) @ t=t_0 \leftarrow x(t) @ t=t_0$$

$$y[n] @ n=n_0 \leftarrow x[n] @ n=n_0$$

Examples

yes $y(t) = x^2(t)$ Squarer
 $y[n] = x^2[n]$

No $y(t) = \int_{-b}^t x^2(\tau) d\tau$

Yes $y[n] = x[n-1]$ Unit delay

INVERTIBILITY

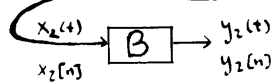
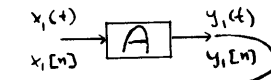

$$x_2 = y_1$$

If \exists = Inverse of A

Then $y_2 = x_1$
Identity

System A:

$$y_1(t) = \int_{-\infty}^t x_1(\tau) d\tau$$
 Integration

System A⁻¹:

$$y_2(t) = \frac{d x_2(t)}{dt}$$
 Differentiation

System A:

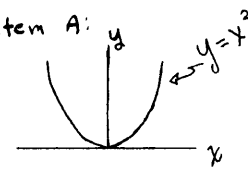

Invertible? No

Memoryless? Yes

MARKERBOARD
3.2

Causality

Output at any time depends only on input prior or equal to that time

or:
System can't anticipate "future" inputs

or:
 $x_1(t) \rightarrow y_1(t)$
 $x_2(t) \rightarrow y_2(t)$

If:
 $x_1(t) = x_2(t) \quad t < t_0$

Then:
 $y_1(t) = y_2(t) \quad t < t_0$

Same for discrete Time

Example:

$$y[n] = \frac{1}{3} \{x[n-1] + x[n] + x[n+1]\}$$

not moving Average

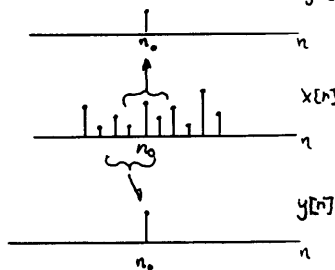

$$y[n] = \frac{1}{3} \{x[n-2] + x[n-1] + x[n]\}$$

causal

Stability

\Rightarrow For every bounded input the output is bounded

Example

$$y(t) = \int_{-\infty}^t x(\tau) d\tau$$

not stable

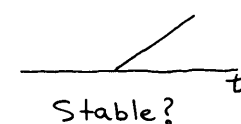

Stable?

DEMONSTRATION

3.1
Illustration of an unstable system.

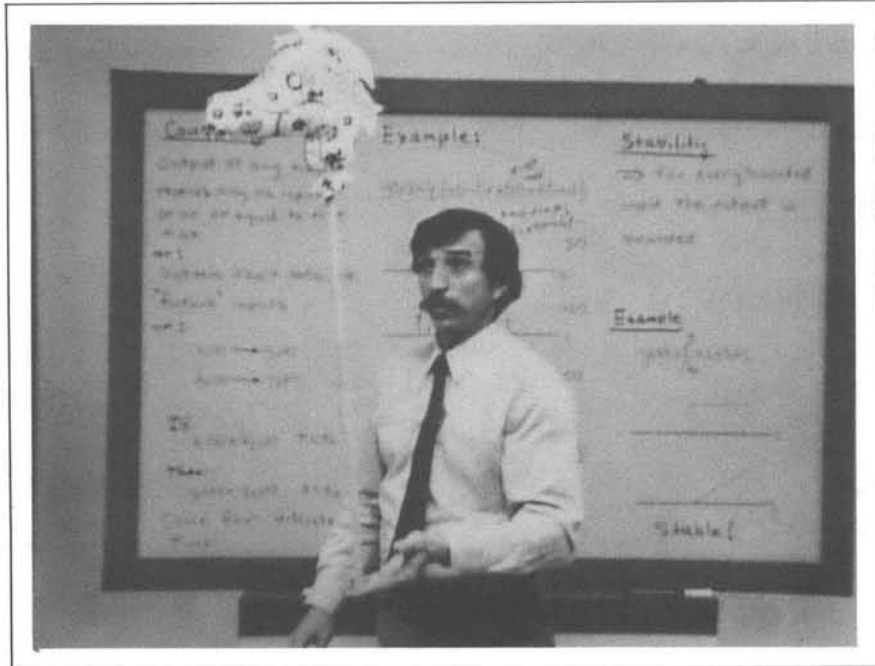

MARKERBOARD

3.3

Time Invariance

C-T;
 $x(t) \rightarrow y(t)$

Then
 $x(t-t_0) \rightarrow y(t-t_0)$

D-T;
 $x[n] \rightarrow y[n]$
Then
 $x[n-n_0] \rightarrow y[n-n_0]$

Example

$y[n] = \sum_{k=-\infty}^n x[k]$

Accumulation

Time Invariant?

Example

$y(t) = (\sin t)x(t)$

$x(t) \rightarrow (\sin t)x(t)$

$x(t-t_0) \rightarrow (\sin t)x(t-t_0)$

≠

$y(t-t_0) = \sin(t-t_0)x(t-t_0)$

Time Invariant? No

Linearity

c.T & D.T

$x_1(t) \rightarrow y_1(t)$

$x_2(t) \rightarrow y_2(t)$

Then:

$a x_1(t) + b x_2(t) \rightarrow a y_1(t) + b y_2(t)$

Examples

$y(t) = \int_{-\infty}^t x(\tau) d\tau$ Yes

$y[n] = 2x[n] + 3$ No

$y[n] = x^2[n]$ Not

MIT OpenCourseWare
<http://ocw.mit.edu>

Resource: Signals and Systems
Professor Alan V. Oppenheim

The following may not correspond to a particular course on MIT OpenCourseWare, but has been provided by the author as an individual learning resource.

For information about citing these materials or our Terms of Use, visit: <http://ocw.mit.edu/terms>.